



**What's better than a real brand  
to promote yours?**

**2 0 2 0**  
GENERAL CATALOGUE





# Take your brand to — — the highest level!

At BIC Graphic Europe, our aim is to offer **quality products** which are made to last. **We promote your brand** with a strong one as a guarantee of quality. **Pioneers and full colour experts**, we have used the latest trends and technology for 50 years to provide the best of our products.

As BIC Group, we have been **committed to the environment** since 2004 with our sustainability program. The future is very important to us. That's why we develop products in agreement with our values.

**Let's continue to write the future together!**



## Our brands:



### FR> Elevez votre marque au Plus haut niveau !

Chez BIC Graphic Europe, notre objectif est d'offrir des **produits de qualité** faits pour durer. **Nous promovons votre marque** au moyen de la nôtre qui est un gage de qualité. **Pionniers et experts** en couleurs, nous employons les tendances et les technologies de pointe de ces 50 dernières années pour offrir le meilleur de nos produits !

Depuis 2004, le Groupe BIC **s'engage pour l'environnement** à travers son programme de développement durable. Le futur est très important pour nous. C'est pour cela que nous développons des produits en accord avec nos valeurs. **Continuons d'écrire le futur ensemble !**

Nos Marques

### ES> Eleva tu marca al más alto nivel

El objetivo de BIC Graphic Europe es ofrecer **productos de calidad**, los cuales están hechos para durar. **Promocionamos tu marca** con otra muy fuerte como garantía de calidad.

**Somos pioneros y expertos en impresión a todo color**. Llevamos 50 años usando las últimas tecnologías para aportar lo mejor a nuestros productos. Como parte del Grupo BIC, desde el 2004 estamos **comprometidos con el medio ambiente** con nuestro programa de sostenibilidad. El futuro es muy importante para nosotros y por ello desarrollamos nuestros productos de acuerdo con nuestros valores.

**¡Sigamos escribiendo el futuro juntos!**

Nuestras marcas

### DE> Bring deine Firma aufs höchste Level!

Bei BIC Graphic Europe ist es unser Ziel **Qualitätsprodukte** anzubieten, die gemacht sind um zu halten. **Wir fördern Ihre Marke** gemeinsam mit einer starken Marke als Garantie für Qualität. Als **Pioniere und Voll Farb Experten** benutzen wir die letzten Trends und neuste Technologie seit 50 Jahren um die besten unserer Produkte anzubieten.

Als BIC Gruppe **widmen wir uns der Umwelt** seit 2004 mit unserem Nachhaltigkeitsprogramm. Die Zukunft ist sehr wichtig für uns. Deshalb entwickeln wir Produkte im Einklang mit unseren Werten. **Lassen Sie uns weiter gemeinsam die Zukunft schreiben!**

Unsere Marken

### IT> Porta il tuo brand su un altro livello!

Noi di BIC Graphic Europe ci siamo prefissati l'obiettivo di offrire "**prodotti di qualità**" fatti per durare. "**Promuoviamo il tuo brand**" con uno altrettanto forte in grado di garantire qualità. **Siamo da sempre pionieri ed esperti del colore**, da 50 anni usiamo le tecnologie più innovative per proporre il meglio dei nostri prodotti.

Noi del Gruppo BIC **ci impegniamo per la salvaguardia dell'ambiente** fin dal 2004 attraverso i nostri programmi di sostenibilità. Il futuro è molto importante per noi: per questo sviluppiamo prodotti che si sposino con i nostri valori.

**Continuiamo a scrivere il futuro insieme!**

I nostri marchi



# What's better than a real brand to promote yours?

FR> Quoi de mieux qu'une grande marque pour promouvoir la vôtre ?

ES> ¿Qué mejor que una gran marca para promocionar la tuya?

DE> Was kann Ihre Marke besser unterstützen als eine starke Marke?

IT> Cosa c'è di meglio di un vero marchio per promuovere il tuo?

## FR> Aller à l'essentiel pour durer

Une histoire de succès, d'innovation et d'engagement.

De l'humble entreprise des débuts à la **marque emblématique** d'aujourd'hui, BIC a su se faire une place de choix dans le quotidien de millions de consommateurs. Entreprise familiale depuis sa création, BIC s'appuie sur une **expertise industrielle unique**, ainsi que sur le savoir-faire de ses collaborateurs pour proposer des produits simples, de qualité et **faits pour durer**.

Notre héritage

### 1944

Marcel Bich (1914-1994) achète une usine à Clichy, en France, et, avec son associé Édouard Buffard (1908-1996), se lance dans la fabrication de pièces d'instruments d'écriture

## ES> Esencial para durar

Una historia de éxito, innovación y compromiso.

Desde el humilde comienzo de la empresa hasta la **marca icónica** de hoy día, ha dejado huella en la vida cotidiana de millones de consumidores. Siendo un negocio familiar desde principio, BIC confía en su **experiencia industrial única** y el saber hacer de sus equipos para ofrecer **productos simples, de alta calidad, y hechos para durar**.

Nuestro patrimonio

### 1944

Marcel Bich (1914-1994) compra una fábrica en Clichy (Francia) y establece un negocio con su socio Edouard Buffard (1908-1996), como fabricante de piezas de instrumentos de escritura.



## DE> Essenziell sein um fortzubestehen

Eine Geschichte des Erfolges, der Innovation und des Engagements.

Von der bescheidenen Firma in ihren Anfängen zur heutigen **Kultmarke**, BIC hat einen Unterschied im Leben von Millionen von Konsumenten gemacht. Als Familienunternehmen, baut BIC von Anfang an auf seine **einzigartige industrielle Expertise** und auf das Wissen seines Teams, um einfache hochwertige Qualitätsprodukte anzubieten die **gemacht sind um zu halten**.

Unser Hintergrund

### 1944

Marcel Bich (1914-1994) kauft eine Fabrik in Clichy Frankreich und startet ein Unternehmen mit seinem Partner Edouard Buffard (1908-1996), als Hersteller von Teilen von Schreibinstrumenten

## IT> L'essenziale dura

Una storia di successo, innovazione e impegno.

Dagli inizi umili fino al **brand iconico** dei giorni nostri, BIC ha lasciato il segno nelle vite di milioni di consumatori. Un'azienda familiare fin dall'inizio, BIC si affida **all'esperienza unica** e al know how dei suoi team per offrire prodotti semplici e di alta qualità fatti per durare nel tempo.

La nostra eredità

### 1944

Marcel Bich (1914-1994) acquista una fabbrica a Clichy (Francia) e avvia un'attività con il suo socio Edouard Buffard (1908-1996) nella produzione di prodotti per la scrittura



## A story of success, innovation and commitment.

From the humble company beginnings to today's **iconic brand**, BIC has made its mark on the daily lives of millions of consumers. A family business from the start, BIC relies on its **unique industrial expertise** and the know-how of its teams to offer simple, high-quality products that are **made to last**.

### OUR HERITAGE

#### **1944**

Marcel Bich (1914-1994) buys a factory in Clichy (France) and sets up business with his partner Edouard Buffard (1908-1996), as a maker of writing instrument parts



Marcel Bich



Edouard Buffard

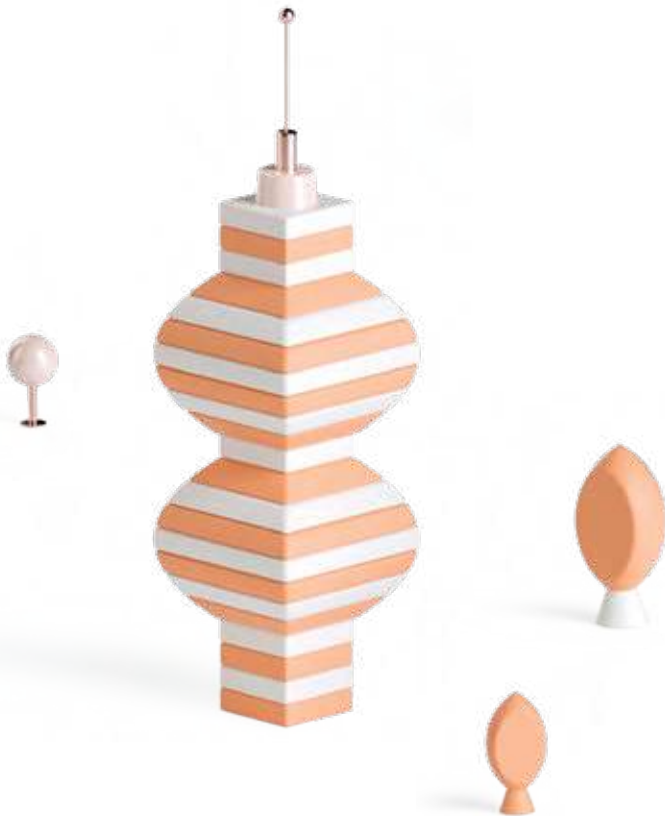

---

**FR> 1950:** Lancement du BIC® CRISTAL®  
**1954-1960:** Expansion géographique en Europe de l'Ouest, en Amérique, au Moyen-Orient et en Afrique  
**1961:** Le logo BIC Boy® est créé  
**1969:** Lancement des produits promotionnels  
**1970:** Lancement du stylo BIC® 4-Couleurs  
**1973:** Lancement du premier briquet de poche BIC®  
**1975:** BIC devient la première marque à lancer un rasoir monobloc  
**1979:** Le groupe bic® ajoute conté® à son catalogue. Marque phare d'instruments graphites d'écriture et de coloriage  
**1993:** • BIC lance BIC® Evolution®, une gamme de crayons graphites et de crayons de couleur fabriqués à partir de matériaux recyclés  
• Bruno Bich est nommé Président et Directeur Général de la SOCIÉTÉ BIC  
**1995:** BIC poursuit son expansion en Europe de l'Est  
**1997:** Acquisition de Tipp-Ex®, le leader des produits de correction sur le marché européen  
**2004:** BIC lance son programme de développement durable  
**2009:** BIC acquiert 40 % de Cello Pens, première marque et premier fabricant d'instruments d'écriture en Inde  
**2015:** Décembre : le groupe Cello vend sa participation résiduelle dans Cello Pens à BIC, qui détient désormais 100 % de Cello Pens  
**2018:** Gonzalve Bich est nommé Directeur Général de BIC

**ES> 1950:** Lanzamiento de BIC® CRISTAL®  
**1954-1960:** Expansión geográfica al oeste de Europa, América, el Oriente Medio y África.  
**1961:** Se crea el logo BIC® Boy  
**1969:** Lanzamiento de productos promocionales  
**1970:** Lanzamiento del bolígrafo BIC® 4 Colours.  
**1973:** Lanzamiento del encendedor de bolsillo BIC®  
**1975:** BIC® es pionero en las maquinillas de afeitar de una pieza  
**1979:** BIC® añade CONTÉ® en su portfolio. Marca líder en instrumentos de escritura de grafito y para colorear.  
**1993:** • BIC® presenta "el BIC® Evolution", un lápiz de grafito y para colorear hecho de material reciclado.  
• Bruno Bich es nombrado Presidente y consejero delegado de SOCIETE BIC.  
**1995:** Más expansión hacia el Este y Europa central.  
**1997:** Adquisición de Tipp-Ex®, el producto líder en Europa de productos de corrección.  
**2004:** BIC® lanza su programa de desarrollo sostenible.  
**2009:** BIC® obtiene el 40% de Cello Pens, la marca y fabricante número uno en India en instrumentos de escritura.  
**2015:** El grupo Cello vende el resto de participaciones a BIC®, fortaleciendo así los intereses de BIC® en Cello Pens en un 100%.  
**2018:** Gonzalve Bich es nombrado consejero delegado de SOCIETE BIC.













---

**DE> 1950:** BIC CHRISTAL wird eingeführt  
**1954-1960:** Geographische Expandierung in West Europa, den Amerikas, dem Mittleren Osten und Afrika  
**1961:** Das bic® boy-logo entsteht  
**1969:** Werbeprodukte werden eingeführt  
**1970:** Einführung des BIC® 4-Color™-Kugelschreibers.  
**1973:** BIC® Taschenfeuerzeug wird eingeführt  
**1975:** BIC führt als Pionier den „einteiligen Rasierer“ ein  
**1979:** Bic ergänzt sein portfolio durch conté®. Leading brand of graphite and colouring writing instrument  
**1993:** • BIC Bringt BIC® Evolution®, einen Graphit und Farbstift heraus, hergestellt aus recycelten Materialien  
• Bruno Bich wird zum Geschäftsführer und Vorstandsvorsitzenden der SOCIETE BIC ernannt.  
**1995:** Weitere Expansion in Ost- und Zentraleuropa  
**1997:** Kauf von Tipp-Ex® den führenden europäischen Korrektionsprodukten  
**2004:** BIC gründet sein Nachhaltigkeit Entwicklungsprogramm  
**2009:** BIC erwirbt 40 % von Cello Pens, die führende Marke und der führende Hersteller von Schreibinstrumenten in Indien  
**2015:** Dezember: Die Cello Gruppe verkauft ihre restlichen Anteile von Cello Pens an BIC, hierdurch wächst BIC's Anteil an Cello Pens auf 100 %  
**2018:** Gonzalve Bich wird zum Vorstandsvorsitzenden der SOCIETE BIC ernannt

**IT> 1950:** Viene lanciata BIC® CRISTAL®  
**1954-1960:** Espansione geografica in Europa occidentale, Americhe, Medio Oriente e Africa  
**1961:** Nasce l'omino BIC®  
**1969:** Lancio di prodotti promozionali  
**1970:** Lancio della penna BIC® 4 Colours  
**1973:** Lancio dell'accendino tascabile BIC®  
**1975:** BIC crea il "rasoio monolama"  
**1979:** BIC® aggiunge CONTÉ® al suo portfolio. Leader negli strumenti per la scrittura in grafito e colorati  
**1993:** • BIC introduce BIC® Evolution®, una matita in grafito e colorata realizzata con materiale riciclato  
• Bruno Bich viene nominato Presidente e Amministratore delegato di SOCIETE BIC  
**1995:** Prosegue l'espansione verso l'Europa centro-orientale  
**1997:** Acquisto di Tipp-Ex®, il marchio europeo leader nella produzione di prodotti per la correzione  
**2004:** BIC lancia il suo programma per lo sviluppo sostenibile  
**2009:** BIC acquista il 40% di Cello Pens, brand indiano leader nella produzione di prodotti per la scrittura  
**2015:** Dicembre: il gruppo CELLO vende la quota restante di Cello Pens a BIC, aumentando le quote di BIC in Cello Pens al 100%  
**2018:** Gonzalve Bich viene nominato Amministratore delegato di SOCIETE BIC



<p><b>1950</b></p> <p>BIC® CRISTAL® is launched</p> 	<p><b>1993</b></p>  <ul style="list-style-type: none"> <li>• BIC introduces BIC® Evolution®, a graphite and coloring pencil made from recycled materials</li> <li>• Bruno Bich is appointed Chairman &amp; Chief Executive Officer of SOCIETE BIC</li> </ul>
<p><b>1954-1960</b></p> <p>Geographic expansion in Western Europe, the Americas, Middle East and Africa</p>	<p><b>1995</b></p> <p>Further expansion in Eastern and Central Europe</p> 
 <p><b>1961</b></p> <p>The BIC® Boy logo is created</p>	 <p><b>1997</b> <b>Tipp-Ex</b></p> <p>Purchase of Tipp-Ex® the leading European brand in correction products</p>
<p><b>1969</b></p> <p>Launch of promotional products</p>	<p><b>2004</b></p> <p>BIC launches its sustainable development program</p> 
 <p><b>1970</b></p> <p>BIC® 4 Colours pen is launched</p>	<p><b>2009</b></p>  <p>BIC acquires 40% of Cello Pens, the leading brand and manufacturer of writing instruments in India</p> <p><b>2015</b></p> <p>December : Cello group sells its remaining stake in Cello Pens to BIC, increasing BIC's stake in Cello Pens to 100%</p>
<p><b>1973</b></p> <p>BIC® pocket lighter is launched</p> 	<p><b>2018</b></p> <p>Gonzalve Bich is appointed Chief Executive Officer of SOCIETE BIC</p>
 <p><b>1975</b></p> <p>BIC pioneers the "one-piece shaver"</p>	<p><b>1979</b></p>  <p>BIC® adds CONTÉ® to its portfolio. A leading brand of graphite and colouring writing instruments</p>

## FR> Aller à l'essentiel pour durer

Entrez dans le quotidien de vos clients !

Les **produits fonctionnels** BIC® deviennent des **icônes**, ils gagnent une plus grande valeur aux yeux de la personne qui les choisit ou qui les reçoit. Soigneusement imprimés avec un marquage spécial et fabriqués en édition limitée, ils deviennent encore plus engageants, comme un **accessoire de mode**. **BIC vous fait cette promesse** avec ses produits.

### Histoire

Un ambassadeur de la marque

En 1950, Marcel Bich lance son propre stylo à bille, le **BIC® Cristal**®. Plus tard, en 1969, des clients commencent à demander des instruments d'écriture BIC® personnalisés avec leur logo. La branche BIC Graphic naît en Europe. **Plus de cinquante ans de savoir-faire dans le secteur des produits promotionnels.**

### Innovation

Disponible pour tous

L'**innovation** a toujours consisté à optimiser la performances des produits BIC® et l'introduction de nouveaux choix simples, inventifs et fiables pour tout le monde, partout, à tout moment. BIC® continue ses **recherches sur de nouvelles façons** d'anticiper le futur dans la commodité et la personnalisation.

## ES> Esencial para durar

¡Sé parte de la vida cotidiana!

**Los productos funcionales de BIC®** se han convertido en **iconos**, tienen más valor a ojos de quien los escoje o recibe. Impresos cuidadosamente con un marcaje especial y fabricados con ediciones limitadas, se convierten en más deseables, como un **accesorio de moda**. Con sus productos, **BIC te ofrece este compromiso.**

### Historia

Embajador de tu marca

En 1950, Marcel Bich lanza su propio bolígrafo, el **BIC® Cristal**®. En 1969 algunos consumidores empezaron a pedir más y más los productos de BIC® personalizados con su logo. Entonces se formó la división BIC Graphic en Europa. **Más de 50 años en el negocio de los productos promocionales.**

### Innovación

Hecho para todos

La **innovación** siempre se ha hecho optimizando el rendimiento de los productos de BIC® existentes e introduciendo lo más simple, lo más ingenioso y nuevas opciones para todo el mundo, en cualquier lugar y en cualquier momento. BIC sigue **explorando nuevas formas** de anticiparse al mañana para la comodidad y personalización

## DE> Essenziell sein um Fortzubestehen

Sei Teil des täglichen Lebens!

**Funktionelle BIC Produkte** wurden zum **Kult**, sie werden sogar noch wertvoller in den Augen von denen, die sie auswählen oder erhalten. Vorsichtig bedruckt mit besonderen Markierungen und in limitierten Editionen hergestellt, werden sie sogar noch begehrenswerter, wie ein **Fashion Accessoire**. Mit seinen Produkten **bietet dir BIC dieses Versprechen.**

### Geschichte

Ein Markenbotschafter

Marcel Bich brachte im Jahr 1950, in Frankreich, seinen eigenen Kugelschreiber, den **BIC® Cristal**®, auf den Markt. Später, im Jahr 1969, baten manche Kunden öfters, dass ihr BIC Schreibinstrument mit einem Logo von Ihnen personalisiert wird. Die BIC Grafik Abteilung wurde daraufhin in Europa gegründet. **Mehr als 50 Jahre Erfahrung im Werbeproduktgeschäft.**

### Innovation

für alle

Bei der **Innovation** geht es stets um die Leistungsoptimierung vorhandener BIC-Produkte und die Einführung einfacher, kreativer und zuverlässiger neuer Optionen für jedermann, überall und jederzeit. BIC forscht weiterhin nach **neuen Wegen**, die Bedürfnisse an Zweckmässigkeit und Personalisierung von morgen vorwegzunehmen.

## IT> L'essenziale dura

Una parte della vita di tutti i giorni!

La **funzionalità** ha reso i **prodotti BIC®** delle vere e proprie **icone**, grazie al valore che acquisiscono agli occhi di chi li sceglie o li riceve. La stampa del marchio e la lavorazione in edizione limitata rende il prodotto sempre più desiderato, una specie di **accessorio moda**. Questa è la **promessa fatta da BIC** con i suoi prodotti.

### Storia

Ambasciatore del brand

Nel 1950 Marcel Bich ha lanciato la penna a sfera **BIC® Cristal**®. Qualche anno dopo, nel 1969, alcuni clienti hanno iniziato a richiedere sempre più spesso prodotti BIC® personalizzati con il proprio logo. Così è nata in Europa la divisione BIC Graphic. **Oltre 50 anni di esperienza nei prodotti promozionali.**

### Innovazione

Translation universale

L'**innovazione** è sempre andata di pari passo con l'ottimizzazione delle prestazioni dei prodotti BIC® e l'introduzione di nuove scelte più semplici, inventive e affidabili, ovunque e in qualsiasi momento. BIC continua a **esplorare nuovi modi** di anticipare le esigenze future nel segno della convenienza e della personalizzazione.



## Be a part of everyday life!



**BIC® functional products** have become **icons**, they take on even greater value in the eyes of the one who chooses or receives them. Carefully printed with a special marking and manufactured in limited editions, it becomes even more desirable, like a **fashion accessory**. With its products, **BIC® offers you this promise.**

### HISTORY



### A BRAND AMBASSADOR

In 1950, Marcel Bich launched BIC's own ball pen, the **BIC® Cristal®**. Later in 1969, some customers started requesting more and more BIC® writing Instruments personalised with their logo. The BIC Graphic division was then formed in Europe. **More than fifty years of skills in the Promotional products business.**

### INNOVATION



### MADE FOR ALL

**Innovation** has always been about optimizing the performance of existing BIC® products and introducing the simplest, most inventive and reliable new choices for everyone, everywhere, every time. BIC continues to **explore new ways** of anticipating tomorrow's appetite for convenience and personalization.

## FR> Emblématique

Un design original. Une marque reliée au design

Des produits innovants dont les designs originaux, inchangés et toujours tendance aujourd'hui, ont déclenché un véritable culte à travers les décennies. **Le BIC® Cristal** est entré dans la collection **permanente du Département de l'architecture et du design au MoMA (Museum of Modern Art) à New York City**. En 2005, le briquet BIC® Maxi le rejoint. Les deux produits, accompagnés du rasoir BIC® original une pièce, ont également rejoint les **collections permanentes du Musée national d'art moderne du Centre Georges Pompidou à Paris en 2006**.

La collection BIC® d'art

Composées de 250 œuvres d'artistes mondialement reconnus ou émergents du monde entier, les pièces de la Collection BIC® d'art ont toutes un point commun : elles ont été **créées en employant ou en tirant leur inspiration de produits BIC® !** La Collection BIC® d'art a ouvert ses portes au public au CENTQUATRE-PARIS (France) au printemps 2018. La connexion qui existe entre **BIC® et les arts ne connaît aucune limite**. Des jeunes artistes du monde entier produisent leurs œuvres en utilisant ou en s'inspirant de produits BIC®.

Fabriqué par BIC®

Quel est le secret de la qualité et de la sécurité universelles des produits BIC®? Ils sont **conçus, fabriqués et testés en interne**, avec des appareils exclusifs développés par BIC® dans ses **26 usines**. Les processus de fabrication originaux évoluent dans les coulisses grâce aux ingénieurs BIC® et sont maîtrisés par des équipes dévouées.

## DE> Kultstatus

Originales Design. Eine Marke mit Design verknüpft

Pioniersprodukte dessen originales Design – intakt und noch heute präsent – eine Kult Gefolgschaft über die Jahrzehnte gestartet haben. **BIC® Cristal** ist Teil der Architektur- und Designabteilung, der **ständigen Ausstellung des MOMA (Museum of Modern Art) in New York**. Im Jahr 2005 trat das BIC® Maxi Feuerzeug hinzu. Und beide Produkte, gemeinsam mit dem einteiligen einklingigen BIC® Rasierer traten im Jahr 2006 der **ständigen Ausstellung des nationalen Museums zeitgenössischer Kunst, Centre Georges Pompidou, in Paris bei**.

Arts

Große kunstsammlung

Bestehend aus mehr als 250 Kunstwerken von international anerkannten oder aufstrebenden Künstlern aus der ganzen Welt, teilen alle Kunstwerke der BIC Kunstsammlung ein gemeinsames Motto: Sie wurden **mit BIC® Produkten kreiert oder von diesen inspiriert!** Die BIC Kunstausstellung debütierte im CENTQUATRE-PARIS (Frankreich) im Frühling 2018. BIC's **Verbindung zu den Künstlern hat keine Grenzen. Junge Künstler aus der ganzen Welt kreieren Werke mit, oder inspiriert von BIC® Produkten**.

Made by BIC

Was ist das Geheimnis der universellen Qualität und Sicherheit der BIC®-Produkte? Sie werden **im Hause entworfen, hergestellt und getestet, und zwar mittels Formen und Maschinen**, die eigens in den **26 Fabriken** von BIC entwickelt wurden. Die Original-Herstellungprozesse entstehen hinter den Kulissen dank BIC-Ingenieuren und werden von engagierten Teams umgesetzt.

## ES> Icónico

Diseño original. Una marca ligada al diseño.



Productos pioneros que sus diseños originales (intactos y que siguen hoy en día) han impulsado un culto a través de las décadas. El bolígrafo **BIC® Cristal** es parte de la colección permanente del **Departamento de Arquitectura y Diseño en el MoMA (Museum of Modern Art) en Nueva York**. En 2005 se unió el encendedor BIC® Maxi. Ambos productos junto con la original maquinilla BIC® entraron también en la **colección permanente del National Modern Art Museum, Centre Georger Pompidou, en París el 2006**.

Arte

Colección de arte BIC®

Con más de 250 trabajos reconocidos internacionalmente por artistas de todo el mundo, todas las obras de la colección de arte BIC® tienen un elemento en común: **¡han sido creadas o inspiradas por productos BIC®!** la colección de arte BIC® tuvo su debut público en CENTQUATRE-PARIS (Francia) en primavera del 2018. **La conexión de BIC® con el arte no tiene límites**. Artistas jóvenes de todo el mundo diseñan obras usando productos BIC® o se inspiran en ellos.

Fabricación Hecho por BIC®

¿Cuál es el secreto de la calidad universal y la seguridad de los productos BIC®? Están **diseñados, fabricados y probados internamente**, con moldes propios y maquinaria hecha por BIC® en sus **26 fábricas**. El proceso de fabricación original evoluciona detrás de las escenas gracias a los ingenieros de BIC® y son equipos organizados y dedicados.

## IT> Iconico

Design originale. Un brand legato al design

Prodotti pionieristici il cui design originale, ancora oggi intatto e attuale, ha dato inizio a un prodotto cult che dura da decenni. **BIC Cristal** fa parte della **collezione permanente** del Dipartimento di architettura e design al **MoMA (Museum of Modern Art) di New York**. **Nel 2005** si è unito anche l'accendino Maxi di BIC®. Entrambi, insieme al rasoio bilama BIC®, sono entrati a far parte nel 2006 delle **collezioni permanenti del Musée National d'Art Moderne al Centro Georges Pompidou di Parigi**.

Arte

Collezione BIC® art

Formata da oltre 250 opere realizzate da artisti rinomati o emergenti, tutti provenienti da ogni parte del mondo, la BIC Art Collection ha un comune denominatore: tutte le sue opere sono state create o ispirate dai prodotti BIC®! La BIC® Art Collection ha fatto il suo debutto a CENTQUATRE-PARIS (Francia) nella primavera del 2018. La connessione di BIC con l'arte non ha davvero confini. Giovani artisti da tutto il mondo creano delle opere utilizzando o prendendo ispirazione dai prodotti BIC®.

Produzione Creato da BIC®

Qual è il segreto della qualità universale e della sicurezza dei prodotti BIC®? Sono **progettati, creati e testati direttamente in fabbrica**, grazie a stampi e macchinari sviluppati appositamente da BIC® nei suoi **26 stabilimenti**. Gli originali processi produttivi evolvono dietro le quinte grazie agli ingegneri BIC® e vengono perfezionati da team dedicati.



## ORIGINAL DESIGN

# Iconic



A brand linked  
to design

Pioneering products whose original designs - intact and still current today - have triggered a cult following across the decades. **BIC® Cristal®** is part of the Architecture and Design Department's **permanent collection at the MoMA (Museum of Modern Art) in New York City**. In 2005, BIC's Maxi lighter joined it. And both products, together with the original one-piece, single-blade BIC® shaver, also entered the **permanent collections of the National Modern Art Museum, Centre Georges Pompidou, in Paris in 2006**.

## ARTS

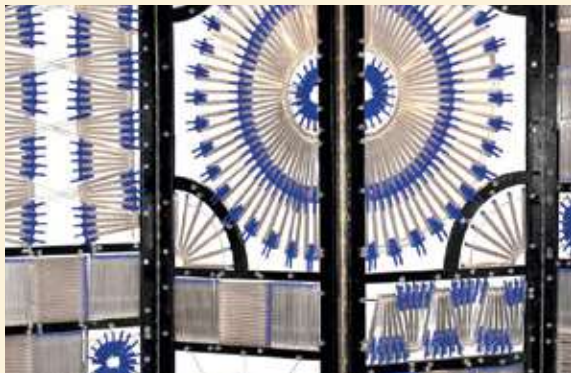

### BIC ART COLLECTION

Consisting of more than 250 works by internationally recognized or upcoming artists from all over the world, works of the BIC Art Collection all share a common theme: they have been **created with or inspired by BIC® products!** The BIC Art Collection made its public debut in CENTQUATRE-PARIS (France) in Spring 2018. **BIC's connection to the arts has no borders.** Young artists all over the world craft pieces using or inspired by BIC® products.

## MANUFACTURING



### MADE BY BIC

What's the secret to the universal quality and safety of BIC® products? They are **designed, manufactured and tested in-house**, with proprietary molds and machinery developed by BIC in its **26 factories**. The original manufacturing processes evolve behind the scenes thanks to BIC engineers and are mastered by dedicated teams.

---

### FR> Aller à l'essentiel pour durer

32 millions de produits choisis chaque jour dans le monde

BIC c'est une histoire de succès, d'innovations, d'engagement inconditionnel pour des **produits de haute qualité** qui nous accompagnent au quotidien. Un **leader mondial** sur le marché des biens de consommation proposer des produits et des solutions de **haute qualité, inventifs et fiables, respectueux de notre environnement et disponibles pour tous.**

Papeterie

20,2 MILLIONS d'articles de papeterie BIC® achetés chaque jour dans le monde entier

- **100%** des billes des stylos sont contrôlées. Parfaitement sphériques, elles sont presque aussi
- **N°2 mondial**

### ES> Esencial para durar

32 Millones de productos BIC® comprados cada día en todo el mundo

BIC es una historia de éxito, una historia de innovaciones, incesante compromiso con **la alta calidad y los productos asequibles** que conducen nuestro día a día. Como líder mundial en bienes consumibles, proveemos productos que son **simples, confiables, ingeniosos, para todos y en cualquier sitio en el mundo.**

Material de papelería

20,2 Millones de productos de oficina BIC® comprados cada día en el mundo.

- El **100%** de los bolígrafos están hechos a través de un proceso altamente controlado. Perfectamente esféricos, son casi tan duros como un diamante.
- **N°2 en el mundo.**

---

### DE> Essenziell sein um Fortzubestehen

32 Millionen BIC® Produkte werden täglich weltweit gekauft

BIC ist eine Erfolgsgeschichte, eine Geschichte der Innovation, uneingeschränktes Streben nach **Hochwertigen und günstigen Produkten** bestimmt unserer tägliches Handeln. Als **weltweit führendes Unternehmen** im Bereich der Gebrauchsgüter bieten wir Produkte an, **die einfach, zuverlässig und einfallsreich sind, für jeden, überall in der Welt.**

Schreibwaren

20,2 MILLIONEN Schreibwaren werden weltweit jeden Tag gekauft

- **100%** der Kugelschreiberkugeln werden unter streng kontrollierten Bedingungen hergestellt. Perfekt Kugelförmig, sind sie fast härter als ein Diamant.
- **Nummer 2 weltweit**

### IT> L'essenziale dura

32 milioni di prodotti BIC® acquistati ogni giorno in tutto il mondo

Quella di BIC è una storia di successo, una storia di innovazione, di inarrestabile impegno alla creazione di **prodotti di alta qualità e convenienti** che guida le nostre azioni quotidiane. Siamo leader mondiali nel beni di consumo e forniamo prodotti **semplici, affidabili, innovativi, per tutti e per ogni angolo del mondo.**

Cancelleria

20,2 MILIONI di prodotti di cancelleria BIC® acquistati ogni giorno nel mondo

- **Tutte** le sfere delle penne sono realizzate grazie a processi altamente controllati. Sono perfettamente sferiche, quasi più dure del diamante
- **N° 2 al mondo**

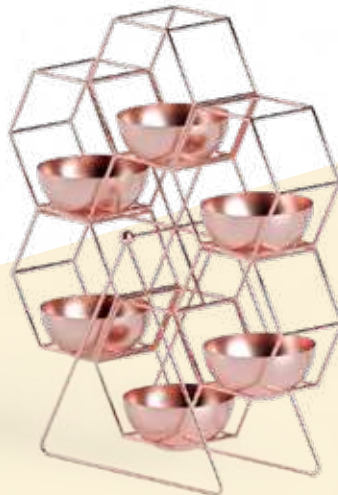

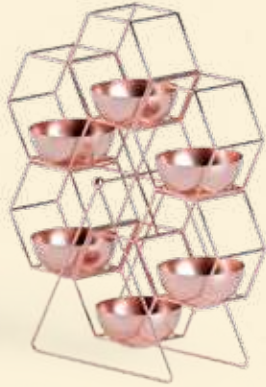

## 32 million BIC® products bought everyday worldwide

BIC is a story of success, a story of innovations, relentless commitment to **high-quality and affordable products** driving our everyday actions. As a **world leader** in Consumer Goods, we provide products which are **simple, reliable, inventive, for everyone and everywhere in the world.**

### STATIONERY



# 20.2



**MILLION BIC®  
Stationery products  
purchased every day  
worldwide**

- **100%** of pen balls are made in-house through a **highly controlled process**. Perfectly spherical, they are almost harder than a diamond
- **N°2 worldwide**

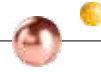

#### FR> Briquets

4,4 MILLIONS de briquets BIC® achetés chaque jour dans le monde entier

- Jusqu'à **3 000 flammes** constantes pour un briquet BIC® Maxi
- Avant de quitter l'usine, chaque briquet BIC® subit **plus de 50 contrôles automatiques de qualité et de sécurité.**
- **N° 1 mondial** des briquets de poche de marque

#### Rasoirs

6,8 MILLIONS de rasoirs BIC® achetés chaque jour dans le monde entier

- Jusqu'à **10 rasages** pour un rasoir BIC® Flex 3
- 100 % des lames de rasoir sont inspectées visuellement : analyse statistique des dimensions, mesure de l'angle d'aiguisage, vérification de la parfaite régularité du tranchant...
- **N° 2 mondial** du rasoir non rechargeable

#### ES> Encendedores

4.4 MILLONES de encendedores bic® comprados cada día en el mundo

- Hasta **3000 encendidas** en un BIC®Maxi pocket.
- Cada encendedor BIC® es sometido a más de 50 **pruebas de calidad y seguridad** antes de salir de fábrica.
- **Nº1 en el mundo** por la personalización de encendedores de bolsillo.

#### Maquinillas de afeitar

6.8 MILLONES de maquinillas de afeitar bic® compradas cada día en el mundo

- Hasta **10 afeitados** con una BIC® Flex 3 razor.
- El 100% de las hojas de las maquinillas de afeitar son **inspeccionadas** visualmente: estadísticas dimensionales e los controles, medición del ángulo de corte, evaluaciones de la suavidad de la hoja, etc.
- **Nº2 en el mundo** de maquinillas de una sola pieza

#### DE> Feuerzeuge

4,4 MILLIONEN Feuerzeuge werden weltweit jeden Tag gekauft

- Bis zu **3000 Zündungen** von einem BIC® Maxi Taschenfeuerzeug
- Alle BIC® Feuerzeuge unterlaufen **mehr als 50 automatische Qualitäts- und Sicherheitschecks** bevor sie die Fabrik verlassen
- **Die weltweite Nummer** eins für Marken Taschenfeuerzeuge.

#### Rasierer

6,8 MILLIONEN Rasierer werden weltweit jeden Tag gekauft

- Bis zu **10 Rasuren** von einem BIC® Flex 3 Rasierer
- 100% aller Rasierklingen sind visuell **überprüft**: dimensionale Statistikkontrollen, Schärfungswinkelmessungen, perfekte Sanftheit der klingenkantigen Einstellung, etc.
- **Nr. 2 weltweit** für einteilige Rasierer

#### IT> Accendini

4,4 MILIONI di accendini BIC® acquistati ogni giorno nel mondo

- Fino a **3.000 accensioni** con un accendino tascabile BIC® Maxi
- Ogni accendino BIC® viene sottoposto a **oltre 50 controlli automatici di sicurezza e qualità** prima di uscire dallo stabilimento
- **N° 1 al mondo** tra gli accendini tascabili di marca

#### Rasoi

6,8 MILIONI di rasoi BIC® acquistati ogni giorno nel mondo

- Fino a 10 rasature con un rasoio BIC® Flex 3
- Il 100% di tutte le lame viene sottoposto a un **controllo visivo**: controlli statistici delle dimensioni, misurazioni dell'angolo di affilatura, verifica dell'uniformità perfetta della lama, ecc.
- **N° 2 al mondo** tra i rasoi costituiti da un unico pezzo

---

## LIGHTERS



4.4

Ⓜ  
**MILLION BIC® Lighters  
purchased every day  
worldwide**

- Up to **3,000 ignitions** from one BIC® Maxi pocket lighter
- Every BIC® lighter undergoes **more than 50 automatic quality and safety checks** before leaving the factory
- **N° 1 worldwide** for branded pocket lighters

---

## SHAVERS



6.8

Ⓜ  
**MILLION BIC® Shavers  
purchased every day  
worldwide**

- Up to **10 shaves** from a BIC® Flex 3 razor
- **100%** of all shaver blades are visually **inspected:** dimensional statistics checks, sharpening angle measurements, perfect smoothness of the blade-edge assessments, etc.
- **N° 2 worldwide** for one-piece shavers

### FR> Aller à l'essentiel pour durer

Une présence mondiale

La mission du Groupe d'offrir **des produits de haute qualité, innovants, accessibles et durables** a façonné notre modèle d'entreprise. Ce modèle donne la priorité à nos ressources en commençant par nos équipes et leur capacité à innover sans limites et soutient également la création de valeur par tous et pour tous. Pour permettre à nos produits d'apporter des solutions simples et efficaces aux besoins quotidiens, notre modèle doit également viser **l'excellence et la simplicité** opérationnelles.

26 Usines à travers le monde

160 Pays dans lesquels des produits Bic sont disponibles

13,664 Employés dans le monde

4 million points de vente

### ES> Esencial para durar

Presencia global

La misión del grupo de ofrecer **productos de alta calidad, innovadores, asequibles y sostenibles** ha dado forma nuestro modelo de negocio. Éste ha puesto en relevancia nuestros recursos, empezando por nuestros equipos y sus infinitas capacidades para innovar, y el apoyo en el valor de la creación de todos y para todos. Para que nuestros productos puedan proveer de soluciones simples y efectivas en las necesidades del día a día, nuestro modelo también tiene el fin de la **excelencia y simplicidad** operacional.

26 fábricas en el mundo.

160 países con productos BIC® disponibles.

13,664 países con productos BIC® disponibles.

4 millones de puntos de venta.

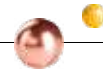

### DE> Essenziell sein um Fortzubestehen

Eine globale Präsenz

Die Mission der Gruppe **hochwertige, innovative, günstige und nachhaltige Produkte** anzubieten hat unser Geschäftsmodell geprägt. Dieses Modell legt Wert auf unsere Ressourcen, angefangen bei unserem Team und seiner grenzenlosen Kapazität zu innovieren und Wertschöpfung zu unterstützen, von allen für alle. Damit unser Produkt einfache und effektive Lösungen für alltägliche Bedürfnisse anbieten kann, muss unser Wirtschaftsmodell nach **betrieblicher Exzellenz und Einfachheit** streben.

26 Fabriken weltweit

160 Länder

13,664 Mitarbeiter weltweit

4 million Verkaufsstellen

### IT> L'essenziale dura

Una presenza globale

La mission del Gruppo di offrire **prodotti di alta qualità, innovativi, convenienti e sostenibili** ha plasmato il nostro modello aziendale. Questo modello mette al centro le nostre risorse, a partire dai nostri team e dalla loro infinita capacità di innovare, e sostiene la creazione di valore da parte tutti e per tutti. Affinché i nostri prodotti offrano soluzioni semplici ed efficaci ai bisogni quotidiani, il nostro modello deve anche puntare **all'eccellenza operativa e alla semplicità**.

26 Stabilimenti in tutto il mondo

160 Paesi in cui sono disponibili i prodotti BIC®

13,664 Collaboratori in tutto il mondo

4 milioni punti vendita





## A global presence



The Group's mission to offer **high-quality, innovative, affordable and sustainable products** has shaped our business model. This model puts a premium on our resources, starting with our teams and their infinite capacity to innovate, and supports value creation by all for all. For our products to provide simple and effective solutions to everyday needs, our model must also aim for operational **excellence and simplicity**.



**26**



Factories around the world



**160**



Countries in which BIC® products are available



**13,664**



Employees worldwide



**4 million**



Points of sale

---

**FR> Une expertise industrielle unique**

BIC<sup>®</sup> usines réparties dans le monde

16 Papeterie

5 Briquets

4 Rasoirs

1 Objets promotionnels

92% de la production combinée des 26 sites génère  
90% du chiffre d'affaires du groupe

100% des instruments d'écriture de bic graphic sont  
marqués sur notre site de production en Espagne

Les usines BIC réparties dans 10 pays de quatre  
continents garantissent la même qualité partout et à  
chaque instant.

**ES> Una experiencia industrial única.**

Las fábricas BIC en el mundo:

16 Productos de escritura

5 Encendedores

4 Maquinillas de afeitar

1 Productos promocionales

El 92% de la combinación de productos e las 26  
fábricas genera el 92% de los ingresos del grupo.

El 100% de los instrumentos de escritura y  
encendedores están impresos en BIC Graphic Europe.

En 10 países, a través de cuatro continentes, las plantas  
BIC garantizan siempre la misma calidad en todas  
partes, en todo momento.

---

**DE> Eine einzigartige industrielle Fachkenntnis**

BIC<sup>®</sup> fabriken weltweit

16 Schreibgeräte

5 Feuerzeuge

4 Rasierer

1 Werbeartikel

92% des Nettoumsatzes der BIC Gruppe wird in BIC  
eigenen Fabriken produziert.

100% der BIC Graphic Europe Schreibgeräte werden in  
unserer Fabrik in Spanien bedruckt.

In 10 Ländern auf vier Kontinenten garantieren die BIC  
Werke überall und jederzeit die gleiche Qualität

**IT> Un esperto industriale unico.**

Fabbriche BIC in tutto il mondo.

16 di Articoli di Scrittura

5 di Accendini

4 di Rasoi

1 di Prodotti Promozionali

92% La produzione combinata dei 26 siti genera il 92%  
della rendita del gruppo.

Il 100% degli strumenti di scrittura e accendini sono  
personalizzati presso BIC Graphic Europe.

In 10 Nazioni, attraverso quattro continenti, gli impianti  
BIC garantiscono la stessa qualità ovunque, sempre.



# A unique industrial expertise

## BIC FACTORIES AROUND THE WORLD

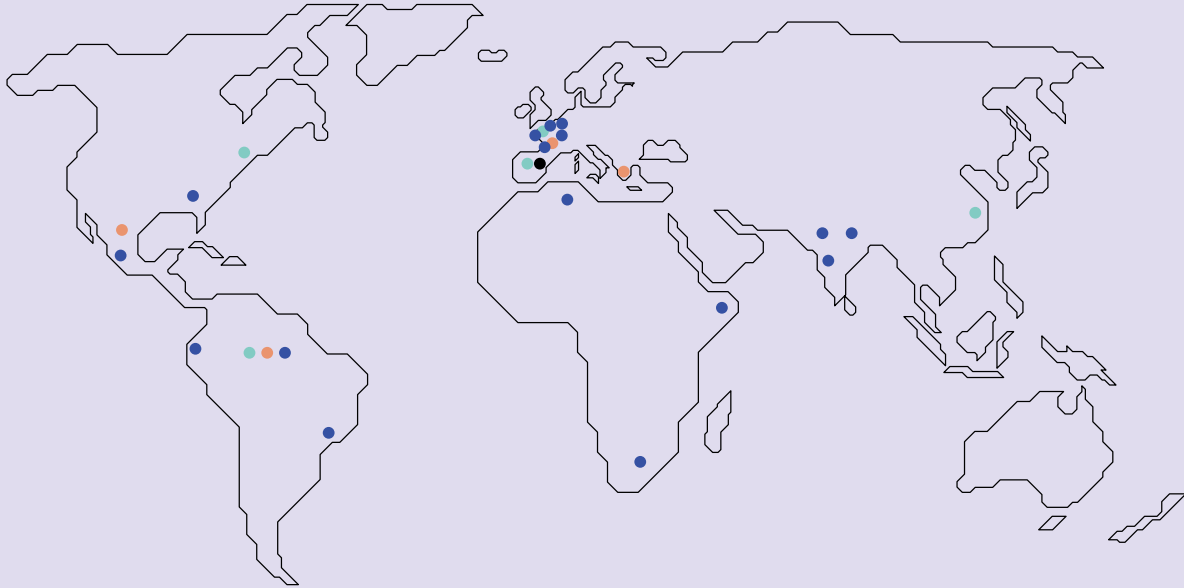

16



Stationery

5



Lighters

4



Shavers

1



Promotional Products

92%



The combined production of the 26 sites generates 92% of the group's revenue.

100%



100% of writing instruments & lighters are printed in BIC Graphic Europe.



In 10 countries, across four continents, BIC's plants guarantee the same quality everywhere, every time.

## FR> Aller à l'essentiel pour innover durablement

La Fondation d'entreprise BIC

La Fondation d'entreprise BIC a pour vocation de contribuer à **l'accès à l'éducation et à un apprentissage de qualité**, en mettant l'accent, à plus long terme, sur le financement de l'entrepreneuriat social et de l'innovation dans l'éducation.

Piliers d'action

- 01 Lutte contre l'échec scolaire
- 02 Accès égalitaire à l'éducation pour les filles et les femmes
- 03 Éducation à l'environnement

Nous soutenons à l'heure actuelle 16 projets dans le monde ! En voici quelques-uns :

Labo des Histoires - France  
Des jeunes de toute la France auront l'opportunité de **participer à des ateliers tenus par des poètes et des écrivains** lors desquels ils seront invités à écrire sur leur relation avec **Pocéan**.  
<http://labodeshistoires.com/lbh/>

Enactus UK  
La Fondation d'entreprise BIC a sponsorisé la compétition « **Quality Education** » en invitant des étudiants d'Enactus travaillant sur des projets liés à l'éducation à présenter leurs idées, à recevoir un financement de lancement et à être encadrés par les membres de nos équipes de BIC UK & Ireland. <http://enactusuk.org/>

- Nous soutenons également
- Le Projet de l'ONG Terre des Hommes « radio Indifesa » en Italie
  - Le centre Kids are kids et le fonds de bienfaisance « Mosaic of happiness » en Russie

## ES> Being essential to foster sustainable innovation

La fundación corporativa de BIC

La Fundación Corporativa de BIC nació del deseo del Grupo de promover sus **actividades cívicas y estructuras** y su **enfoque filantrópico** mientras reforzaban el sentimiento de pertenencia y orgullo de sus equipos. Su misión es **apoyar el acceso a la educación y a la buena calidad del aprendizaje**, poniendo énfasis, a largo plazo, en la iniciativa empresarial social y la innovación en la educación.

Sus pilares de acción son

- 01 La reducción del abandono escolar
- 02 Acceso igualitario a la educación para niñas y mujeres.
- 03 Educación medioambiental.

16 proyectos están siendo apoyados por todo el mundo! Mira alguno de ellos:

Labo des histoires - Francia  
Jóvenes de toda Francia tendrán la oportunidad de **participar en workshops hechos por poetas y escritores**, donde serán invitados a escribir sobre sus relaciones con el **océano**.  
<http://labodeshistoires.com/lbh/>

Enactus UK  
La Fundación Corporativa de BIC sponsorizó la competición "**Quality Education**", invitando a estudiantes que trabajan en proyectos de Enactus a escoger sus ideas, recibiendo fondos iniciales y siendo mentores por nuestro equipo BIC UK & Ireland. <http://enactusuk.org/>

- Nous soutenons également
- Proyecto "Radio Indifesa" NGO Terre des Hommes en Italia.
  - El centro "Los niños son niños", el fondo caritativo "Mosaic of happiness" en Rusia.

## DE> Essenziell sein um nachhaltige innovation zu fördern

Die BIC Unternehmensstiftung

Die BIC Unternehmensstiftung wurde aus dem Wunsch der Gruppe heraus ins Leben gerufen, ihre **Bürgerinitiativen zu fördern und ihre philanthropische Herangehensweise zu strukturieren**, während sie in ihren Teammitgliedern den Sinn für Stolz und Zugehörigkeit erhöht. Die Mission ist die **Unterstützung zum Zugang zur Bildung und der Zugang zu guten qualitativen Instruktionen**, mit einem Schwerpunkt auf Langfristigkeit, auf der Grundlage eines sozialen Unternehmertums und der Innovation in Bildung.

Ihre Aktionsschwerpunkte sind

- 01 Anzahl der Schulabbrecher reduzieren
- 02 Gleicher Zugang zur Bildung für Mädchen und Frauen
- 03 Umwelterziehung

16 Projekte werden aktuell auf der ganzen Welt unterstützt! Schau dir manche von ihnen an:

Labo des histoires - Frankreich  
Jugendliche aus ganz Frankreich werden die Möglichkeit haben an **Workshops teilzunehmen, die von Poeten und Schriftstellern geleitet werden**. Hier werden sie eingeladen über ihre Beziehung mit dem **Ozean** zu schreiben.  
<http://labodeshistories.com/lbh>

Enactus UK  
Die BIC Unternehmensstiftung sponsert den "**Bildungsqualitäts**" Wettbewerb, indem es die Enactus-Studenten einlädt an Bildungsprojekten zu arbeiten um ihre Ideen vorzuschlagen, während sie Startkapital erhalten und von unseren BIC GB und Irland Teammitgliedern betreut werden.  
<http://enactusuk.org/>

We also support

- Project "radio Indifesa" NGO Terre des Hommes in Italien
- Kinder sind Kinder Center, Der Wohlfahrtsfond „Mosaik der Freude“ in Russland

## IT> Essenziale per promuovere l'innovazione sostenibile

La BIC Corporate Foundation

La BIC Corporate Foundation è nata dal desiderio del Gruppo di promuovere le proprie **attività nella società civile** e di **avere un approccio filantropico** sostenendo nel contempo il senso di orgoglio di appartenenza dei membri del proprio team. L'obiettivo è di **supportare l'accesso all'istruzione e all'istruzione di qualità**, ponendo l'accento, nel lungo periodo, sul sostegno dell'imprenditorialità sociale e l'innovazione nell'istruzione.

I pilastri della sua azione sono

- 01 Riduzione dell'abbandono scolastico
- 02 Pari opportunità di accesso all'istruzione per ragazze e donne
- 03 Educazione ambientale

Attualmente sosteniamo 16 progetti in tutto il mondo! Eccone alcuni:

Labo des histoires - Francia  
I giovani provenienti da tutta la Francia avranno l'opportunità di **partecipare a workshop tenuti da poeti e scrittori**, durante i quali saranno invitati a scrivere del proprio rapporto con l'oceano.  
<http://labodeshistoires.com/lbh/>

Enactus UK  
La BIC Corporate Foundation ha sponsorizzato la competizione "**Quality Education**", invitando gli studenti Enactus a lavorare a progetti educativi per lanciare le proprie idee, ottenere dei finanziamenti start-up e ricevere mentoring dal nostro team BIC UK & Ireland. <http://enactusuk.org/>

- Nous soutenons également
- Progetto "radio Indifesa", ONG Terre des Hommes in Italia
  - Centro per bambini gestito dall'associazione "Mosaic of happiness" in Russia



## The BIC Corporate Foundation

The BIC Corporate Foundation was born out of the Group's desire to promote its **civic activities and structure** its **philanthropic approach** while bolstering its team members' sense of pride and belonging. Its mission is to **support access to education and good quality Teaching**, putting the emphasis, over the long term, on the funding of social entrepreneurship and innovation in education.

### Its pillars of action are

01

Reducing school dropout

02

Equal access to education for girls and women

03

Environmental education

16 projects are currently supported all around the world! Take a look at some of them:

#### I LABO DES HISTOIRES - FRANCE

Youngsters from all over France will have the opportunity to **participate in workshops led by poets and writers**, where they'll be invited to write about their relationship with the **ocean**. <http://labodeshistoires.com/lbh/>

#### II ENACTUS UK

The BIC Corporate Foundation sponsored the **"Quality Education"** competition, inviting Enactus students working on education projects to pitch their ideas, receive seed-funding and be mentored by our BIC UK & Ireland team members. <http://enactusuk.org/>

#### WE ALSO SUPPORT



• Project "radio Indifesa" NGO Terre des Hommes in Italy



• Kids are kids center, the charity fund "Mosaic of happiness" in Russia

---

### FR> Global La semaine mondiale de l'éducation

Education, a long-standing commitment of BIC Group

L'éducation, un engagement de longue date du Groupe BIC. Depuis 1950, BIC favorise l'éducation et **aide les enfants** pour leur permettre de réussir à apprendre en leur offrant de meilleures conditions d'apprentissage et en promouvant l'écriture manuelle et ses bénéfices. Avec la volonté d'aller plus loin, BIC a lancé ses engagements de développement durable horizon 2025 pour lesquels l'éducation est un pilier central avec **l'objectif ambitieux d'améliorer les conditions d'apprentissage de 250 millions d'enfants dans le monde d'ici 2025**.

Pour atteindre cet objectif et respecter cet engagement, BIC a lancé sa première semaine mondiale de l'éducation. Chaque année pendant la semaine mondiale de l'éducation BIC, les membres de nos équipes répartis sur 63 sites BIC de 40 pays du monde entier se sont portés volontaires pour consacrer une journée de travail pour aider à améliorer les conditions d'apprentissage des enfants et des étudiants au sein de leurs communautés locales, apportant leur grain de sable pour faire la différence durablement.refurbishments.

### ES> Semana mundial de la educación

La educación, un consolidado compromiso del grupo BIC

Desde 1950, BIC siempre ha promovido la educación y **ayudado a los niños** en su aprendizaje ofreciéndoles mejores condiciones e estudio y fomentando la escritura a mano y sus beneficios. BIC ha lanzado su programa de desarrollo sostenible para 2025, en el que la educación es un pilar fundamental, con el **ambicioso objetivo** de mejorar las **condiciones de aprendizaje de 250 millones de niños** en todo el mundo de aquí a 2025.

Para respaldar su objetivo y su compromiso, BIC organizó en octubre de 2018 la primera **Semana Mundial de la Educación**. Cada año durante esta semana, los miembros del equipo de 40 países y de más de 63 plantas de BIC participaron como voluntarios durante una jornada de trabajo para ayudar a mejorar las condiciones de aprendizaje de los niños y estudiantes de sus comunidades, aportando su granito de arena para marcar una diferencia duradera.

---

### DE> Globale Bildungswoche

Bildung, ein seit langer Zeit bestehendes Engagement der BIC Gruppe

Seit 1950 hat BIC immer Bildung gefördert und **Kindern geholfen** beim lernen erfolgreich zu sein, indem es bessere Konditionen fürs Lernen geboten hat sowie durch die Förderung des handschriftlichen Schreibens und dessen Vorteile. Mit dem Wunsch dies weiter voranzutreiben hat BIC sein 2025 Nachhaltigkeit-Entwicklungengagement eingeführt, mit Bildung als Aktionsschwerpunkt und dem **ambitiösen Ziel die Lernsituation bis zum Jahr 2025 für 250 Million Kinder weltweit** zu verbessern.

Zur Unterstützung dieses Ziels und Engagements hat BIC im Oktober 2018 dessen erste **globale Bildungswoche** eingeführt. Jedes Jahr, während der BIC globalen Bildungswoche haben unsere Mitarbeiter in 40 Ländern und in 63 BIC Einrichtungen auf der ganzen Welt freiwillig, bis zu einem Tag, geholfen die Lernsituation für Kinder und Studenten in ihren Gemeinschaften zu verbessern. Sie haben ihren Teil dazu beigetragen eine langfristige Veränderung herbeizuführen. actions ranging from homework support for children to complete school refurbishments.

### IT> Global education week

Istruzione, un impegno costante del gruppo BIC

Dal 1950, BIC si è sempre fatta promotrice della diffusione dell'istruzione **aiutando i bambini** nel raggiungimento dei loro risultati scolastici. Lo ha fatto fornendo migliori condizioni di apprendimento e attraverso la promozione della scrittura a mano e dei suoi benefici. BIC ha lanciato i suoi impegni di sviluppo sostenibile per il 2025: tra questi l'istruzione rappresenta un pilastro, con **l'obiettivo ambizioso di migliorare entro il 2025 le condizioni di apprendimento per 250 milioni di bambini in tutto il mondo**.

Per supportare questo obiettivo e impegni, BIC ha lanciato nel 2018 la sua prima **Global Education Week**. Ogni anno, durante la BIC Global Education Week, i membri del nostro team in 40 Paesi e 63 stabilimenti BIC nel mondo svolgono fino a una giornata di volontariato lavorando per aiutare a migliorare le condizioni di apprendimento di bambini e studenti nelle loro comunità locali, dando il loro contributo nel fare la differenza.



---

# Global

---

# education week



## Education, a long-standing commitment of BIC Group

Since 1950, BIC® has always been promoting Education and **helping children** succeed in learning by providing better conditions of learning and through the promotion of handwriting and its benefits. BIC has launched its 2025 sustainable development commitments in which Education is a key pillar, with an **ambitious goal** of improving **learning conditions for 250 million children globally** by 2025.

In support of this objective and commitment, BIC launched in 2018 its first **Global Education Week**. Every year during the BIC Global Education Week, our team members in 40 countries and across 63 BIC sites around the world volunteer up to a day of work to help to improve learning conditions for children and students within their local communities, doing their share to make a lasting difference.



**FR> Produits durables**  
**Un futur durable à écrire ensemble**

L'engagement du Groupe "Writing The Future, Together", formulé en 2017, signe une nouvelle étape dans la démarche engagée par BIC depuis 2004. Ces **engagements ambitieux à horizon 2025**, essentiels à la stratégie de l'entreprise, engagent BIC vers une philosophie **d'action et de transformation** qui influence l'intégralité de l'entreprise.

Cet engagement couvre cinq domaines stratégiques

01 Favoriser l'innovation durable dans les produits BIC\*. Un design simple et inventif, nécessitant peu de matières premières et garantissant une longue durée de vie.

02 Agir contre le changement climatique. Le Groupe BIC adopte une approche globale au regard de la consommation énergétique (efficacité énergétique, utilisation d'énergies renouvelables, etc.),

03 S'engager pour la sécurité au travail. Le Groupe objectif : offrir un environnement de travail sûr et propice au développement.

04 Impliquer les fournisseurs de manière proactive. Notre équipe Achats analyse l'ensemble des risques, puis sélectionne nos fournisseurs stratégiques et travaille de concert avec ces derniers en adoptant une démarche responsable.

05 S'investir pour une vie meilleure à travers l'éducation. L'éducation, qui a le pouvoir de changer le monde, a toujours été au centre des préoccupations du Groupe.

**ES> Productos sostenibles**  
**Escribiendo un futuro sostenible juntos**

El compromiso del Grupo "Escribiendo el futuro, juntos", elaborado en 2017, es el siguiente paso en un viaje que BIC comenzó en 2004. Este programa **ambicioso para 2025**, integrado en la estrategia de la Compañía, compromete a BIC en una filosofía de acción y transformación que tiene impacto en toda la compañía.

Se aplica en 5 áreas estratégicas

01. Fomentando la innovación de los productos BIC\*. Diseños simples e inventivos, con menos materia prima y más rendimiento.

02. Actuando contra el cambio climático. Un acercamiento global al consumo de energía (energía eficiente, uso de energía renovable, etc.)

03. Compromiso para salvar el medio ambiente. BIC tiene el objetivo de proveer un espacio de trabajo seguro y propicio.

04. Involucrando proactivamente a proveedores. Nuestros equipos de compra analizan todos los riesgos, seleccionan y colaboran con nuestros proveedores más estratégicos que sigan una adquisición responsable.

05. Mejorando vidas a través de la educación. La educación tiene el poder de cambiar el mundo, y por ello siempre ha estado en el corazón de las inquietudes del grupo.



**DE> Nachhaltige Produkte**  
**Zusammen die nachhaltige Zukunft schreiben**

Das Engagement der Gruppe „Die Zukunft gemeinsam schreiben“, formuliert im Jahr 2017, ist der nächste Schritt auf der Reise, die BIC im Jahr 2004 startete. Dieses **ambitiöse 2025 Programm**, wesentlich in der Firmenstrategie, strebt nach einer Philosophie der **Leistung und Transformation**, die die gesamte Firma prägt.

Sie wird in fünf verschiedenen strategischen Gebieten angewandt:

01 Förderung nachhaltiger Innovation bei BIC\* Produkten. Einfache, einfallsreiche Designs, mit weniger Rohmaterial und langlebiger Leistung

02 Klimawandel entgegensteuern. Eine globale Herangehensweise an den Energieverbrauch (Energieeffizienz, Gebrauch von erneuerbaren Energien, etc.)

03 Selbstverpflichtung zu einem sicheren Umfeld. BIC strebt danach ein sicheres und förderndes Arbeitsumfeld zu bieten.

04. Proaktiv Lieferanten miteinbeziehen. Unsere Kaufteams analysieren alle Risiken, wählen und kollaborieren mit unseren strategischsten Lieferanten gemäß einer verantwortungsbewussten Herangehensweise.

05 Leben verbessern durch Bildung. Weil Bildung die Möglichkeit schafft die Welt zu verändern, lag diese der Gruppe immer am Herzen.

**IT> Prodotti sostenibili**  
**Scriviamo il futuro sostenibile insieme**

L'impegno preso dal Gruppo nel 2017, "Writing the Future, Together", è il prossimo passo in un percorso iniziato da BIC nel 2004. Questo **ambizioso programma 2025**, parte integrante della strategia della Società, impegna BIC al perseguimento di una filosofia di **azione e trasformazione** il cui impatto influisce sull'intera società.

Applicazione in cinque aree strategiche

01 Incentivo all'innovazione sostenibile nei prodotti BIC\*. Design semplici e innovativi con meno materie prime e prestazioni che durano nel tempo.

02 Azione contro i cambiamenti climatici. Un approccio globale al consumo energetico (efficienza energetica, uso di energia proveniente da fonti rinnovabili, ecc.).

03 Impegno verso un ambiente sicuro. BIC mira a fornire un ambiente di lavoro sicuro e che favorisca la crescita professionale.

04 Coinvolgimento proattivo dei fornitori. Il nostro team acquisti analizza tutti i rischi, seleziona e collabora con i fornitori più strategici seguendo un approccio responsabile.

05 Miglioramento delle vite grazie all'istruzione. Poiché l'istruzione ha il potere di cambiare il mondo, è sempre stato il cuore delle istanze del Gruppo.





## Writing the sustainable future together

The Group's "Writing the Future, Together" commitment, formulated in 2017, is the next step in a journey BIC started in 2004. This **ambitious by 2025 program**, integral to the Company's strategy, commits BIC to a philosophy of **action and transformation** that impacts the whole company.

## It is applied in five strategic areas

### 01 **FOSTERING SUSTAINABLE INNOVATION IN BIC PRODUCTS**

Simple, inventive designs, with less raw materials and long life performance.

### 02 **ACTING AGAINST CLIMATE CHANGE**

A global approach to energy consumption (energy efficiency, use of renewable energy, etc.).

### 03 **COMMITTING TO A SAFE ENVIRONMENT**

BIC aims to provide a safe and nurturing workplace.

### 04 **PROACTIVELY INVOLVING SUPPLIERS**

Our purchasing teams analyse all the risks, select and collaborate with our most strategic suppliers following a responsible approach.

### 05 **IMPROVING LIVES THROUGH EDUCATION**

Because education has the power to change the world, it has always been at the heart of the Group's concerns.



Watch the video and learn more about Sustainable development  
[bicworld.com/en/our-commitments/overview](https://bicworld.com/en/our-commitments/overview)

---

### FR> Agir contre le changement climatique

L'utilisation d'une énergie renouvelable contribuera à réduire de manière notable les émissions de gaz à effet de serre générées par BIC d'ici à 2025.

L'engagement du groupe bic pour 2025  
D'ici 2025, BIC utilisera de l'électricité à 80 % d'origine renouvelable.

Où se place BIC Graphic europe en 2020 ?  
Le usine et nos installations d'impression BIC Graphic de Tarragone sont alimentées avec de l'électricité 100% renouvelable.

### ES> Actuando contra el cambio climático

El uso de electricidad renovable contribuirá a reducir las emisiones de gas invernadero de BIC significativamente para 2025.

Compromiso del grupo bic para 2025  
Para 2025 BIC usará un 80% de electricidad renovable.

¿Dónde estará BIC Graphic en 2020?  
La fábrica y las técnicas de impresión están usando el 100% de electricidad renovable.

---

### DE> Dem Klimawandel entgegensteuern

Der Gebrauch von erneuerbarem Strom wird zur Reduktion von BIC's Treibhausgasemissionen bis 2025 beitragen.

BIC gruppe selbstverpflichtung 2025  
Im Jahr 2025 wird BIC 80 % erneuerbaren Strom nutzen.

Wo ist BIC Graphic Europe im Jahr 2020 ?  
Fabriken und Druckeinrichtungen benutzen 100 % erneuerbaren Strom.

### IT> Azione contro il climate change

L'uso di energia elettrica proveniente da fonti rinnovabili contribuirà a ridurre le emissioni di gas serra di BIC entro il 2025.

L'impegno di bic per il 2025  
Entro il 2025 BIC utilizzerà l'80% di energia elettrica da fonti rinnovabili.

A che punto è BIC Graphic nel 2020 ?  
Gli stabilimenti e gli impianti di stampa utilizzando il 100% di energia elettrica da fonti rinnovabili.





# Acting against — — **climate change**

The use of renewable electricity will contribute to reducing BIC's greenhouse gas emissions significantly by 2025.

**BIC GROUP COMMITMENT FOR**

# 2025

By 2025, BIC will use  
80% renewable electricity.



**WHERE IS BIC GRAPHIC  
EUROPE IN 2020?**

Factory and printing  
facilities are using

# 100%

renewable electricity.

## FR> Produits durables

### Ubicuity™ : un modèle d'économie circulaire unique

Dès 2011, le Groupe s'est associé en Europe à **TerraCycle**, entreprise pionnière du recyclage des déchets en plastique petits et complexes, pour créer de toutes pièces un programme de collecte des instruments d'écriture, quel que soit leur fabricant, sur les lieux mêmes de consommation (écoles, bureaux, etc.). En 2017, BIC a lancé **Ubicuity™**, une gamme de mobilier extérieur, fabriquée à partir de cette matière collectée, et commercialisée par la société française Plas Eco auprès des collectivités et de nombreux établissements scolaires.

**100 % des BIC instruments d'écriture sont recyclables grâce à Ubicuity™ renouvelable.**

**Vous collectez / Nous recyclons / Nous transformons**

## ES> Productos sostenibles

### Ubicuity™: un modelo económico circular único

En 2011, BIC se asoció en Europa con **TerraCycle**, una firma pionera en la industria del reciclaje de plásticos. Juntos crearon un vasto programa para recoger todos los instrumentos de escritura, independientemente de su fabricación, directamente de donde son usados, en escuelas, oficinas, etc. En 2017, BIC presentó **Ubicuity™**, una gama única de mobiliario exterior hecho exclusivamente de estos plásticos reciclados recolectados por la empresa francesa Plas Eco.

**100% de los instrumentos de escritura de BIC son reciclados gracias a Ubicuity™**

**Tu recoges / Nosotros reciclamos / Nosotros transformamos**

## DE> Nachhaltige Produkte

### Ubicuity™: ein einzigartiges Kreislaufwirtschaftsmodell

Bereits im Jahr 2011 schloss sich BIC in Europa mit **TerraCycle** zusammen, einer Pionierfirma in der Plastik Recycling Industrie. Zusammen gründeten sie ein weitreichendes Programm um alle Schreibinstrumente, unbeachtet von welchem Hersteller, zu sammeln. Direkt dort, wo sie benutzt werden, in Schulen, Büros, etc. In 2017 führte BIC **Ubicuity™** ein, eine einzigartige Produktreihe von Gartenmöbeln, ausschließlich hergestellt aus recyceltem Plastik, gesammelt von der französischen Firma Plas Eco. 100% der Schreibinstrumente sind Dank Ubicuity™ recycelbar.

**100% der Schreibinstrumente sind Dank Ubicuity™ recycelbar.**

**Sie sammeln / Wir recyceln / Wir verwandeln**

## IT> Prodotti sostenibili

### Ubicuity™: un modello unico di economia circolare

Nel 2011 BIC ha unito le forze con **TerraCycle**, un'azienda pionieristica nel settore del riciclo della plastica. Insieme hanno creato un ampio programma per raccogliere tutti gli strumenti di scrittura, indipendentemente dal produttore, direttamente dal luogo in cui questi vengono utilizzati (scuole, uffici, ecc.). Nel 2017, BIC ha introdotto **Ubicuity™**, una gamma unica di complementi d'arredo per il giardino realizzati esclusivamente dalla plastica riciclata raccolta dall'azienda francese Plas Eco.

**Il 100% degli strumenti di scrittura BIC sono riciclabili grazie a Ubicuity™**

**Tu raccogli / Noi ricicliamo / Noi ricicliamo**





Watch the video  
The "write" kind of bench

## Ubicuity™ : a unique circular economy model

In 2011, BIC partnered in Europe with **TerraCycle**®, a pioneering firm in the plastics recycling industry. Together, they created a vast program to collect all writing instruments, regardless of manufacturer, directly from where they are used, in schools, offices, etc. In 2017, BIC introduced **Ubicuity™**, a one-of-a-kind range of outdoor furniture made exclusively from these collected recycled plastics by French company Plas Eco.

**100% of BIC® writing instruments are recyclable thanks to Ubicuity™**



**YOU COLLECT**



**WE RECYCLE**



**WE TRANSFORM**



## FR> La responsabilité sociale d'entreprise BIC' Graphic

### ISO 9001 - ISO 14001

Par Lloyd's Register, relatives aux systèmes de gestion intégrée pour les installations de Tarragone (Espagne).

#### Nos produits certifiés NF :

Certification NF attestant la conformité des produits et des services suivant les normes nationales et internationales européennes.

#### Coca-Cola / Un score de 0 non-conformité

L'audit de Coca-cola a été passé avec brio en obtenant le meilleur résultat positif pour une audit dans le domaine du respect des normes de travail, des droits humains, de la santé et la sécurité, de la gestion environnementale et de l'intégrité commerciale.

#### AMFORI:

Membre de l'association d'entreprises leader dans le monde pour le commerce ouvert et durable. Elle rassemble plus de 2 400 détaillants, importateurs, marques et associations répartis dans plus de 40 pays.

#### SMETA 4-pillar audited

4 Piliers : Environnement  
Éthique des affaires  
Santé et Sécurité Normes du travail

#### UN Global Compact

Membre officiel de la famille du Pacte mondial des Nations Unies, -la plus importante initiative de durabilité des entreprises au monde.

#### ECOVADIS

Reconnaissance gold  
BIC Graphic s'est vu décerner un niveau de reconnaissance GOLD par Ecovadis

#### Des sites web au bilan carbone neutre:

Collaboration à l'initiative de durabilité avec le Global Climate Institute.

#### IMPRIM' VERT

Qualifié et référencé pour IMPRIM' VERT. Engagement des entreprises dans le domaine de l'impression pour la réduction de l'impact de leur activité sur l'environnement.

#### Workplace Conditions Assessment

Classé comme conforme aux exigences du programme Workplace Conditions Assessment

#### Our Awards

PSI Sustainability Awards / Pour la troisième année consécutive  
2017-2019  
2019 1<sup>er</sup> place Excellence Économique. Nous basant sur un système de contrôle qualité strict  
2017 1<sup>er</sup> place Excellence Économique. 1<sup>er</sup> place Produits durables  
2018 1<sup>er</sup> place Initiative sociale  
3<sup>e</sup> place Initiative pour l'environnement

## ES> La responsabilidad social de BIC' Graphic Corporación

### ISO 9001 - ISO 14001

Sistema integrado de gestión de certificaciones para las instalaciones de Tarragona de Lloyd's Register.

**Nuestro certificado de productos NF**  
La Certificación NF da fe de la conformidad de productos y servicios con los documentos normativos nacionales, europeos e internacionales.

#### Coca-Cola / Resultado de 0 no conformidades

La auditoría social de Coca-Cola pasó con la máxima puntuación en términos de cumplimiento con las Normas Laborales y Derechos Humanos, Salud y Seguridad, Gestión Medioambiental y Negocios de Integridad

#### AMORFI:

Miembros de la asociación global empresarial líder para el comercio abierto y sostenible. Juntan más de 2400 minoristas, importadores, marcas y asociaciones de más de 40 países.

#### SMETA 4 pilares auditados

4 pilares: medioambiental, ética de negocio, salud y seguridad, trabajo

#### UN Global Compact

Somos parte oficial de la familia del Compacto Global de las Naciones Unidas, la iniciativa corporativa sostenible más grande del mundo.

#### ECOVADIS

Reconocimiento dorado  
Nos ha sido otorgada la medalla de oro por Ecovadis.

#### Carbon neutral website

Miembros de la nueva iniciativa sostenible en colaboración con el Instituto del Clima Global.

#### IMPRIM' VERT

Calificados por IMPRIM' VERT, un compromiso para actividades de impresión empresarial para reducir el impacto de su actividad en el medio ambiente.

#### Workplace Conditions Assessment

Evaludados por Intertek con la conformidad a los requerimientos de: Evaluación de las Condiciones del Puesto de Trabajo.

#### Our Awards

PSI Sustainability Awards / Tres años consecutivos 2017-2019  
2019 1<sup>er</sup> puesto Excelencia Económica basada en una estricta estructura de cualidad de gestión del sistema.  
2017 1<sup>er</sup> puesto Excelencia económica  
1<sup>er</sup> puesto Productos sostenibles  
2018  
1<sup>er</sup> puesto Iniciativa social  
3<sup>er</sup> puesto Iniciativa medioambiental

## DE> BIC' Graphic Corporate social responsibility

### ISO 9001 - ISO 14001

Zertifizierungen für integrierte Qualitäts- und Umweltmanagementsysteme für ihre Werke in Tarragona (Spanien) vom Lloyd's Register erhalten.

**Unsere NF-zertifizierten Produkte:**  
NF Zertifikate garantieren die Übereinstimmung der Produkte und Leistungen mit nationalen, europäischen und internationalen, normativen Dokumenten.

#### Coca-Cola / Ergebnis von 0 Nichtkonformitäten

Das Coca-Cola Sozialaudit wurde bestanden mit dem höchsten positiven Auditergebnis in Bezug auf Übereinstimmung mit Arbeitsstandards und Menschenrechten, Gesundheit und Sicherheit, Umwelt Management und wirtschaftlicher Integrität.

#### AMFORI:

Mitglied der führenden, globalen Wirtschafts Vereinigung für einen offenen und nachhaltigen Handel. Sie bringen mehr als 2400 Einzelhändler, Importeure, Marken und Vereinigungen aus mehr als 40 Ländern zusammen.

#### SMETA 4 aktionsschwerpunkte geprüft

4 Aktionsschwerpunkte: Umwelt, Wirtschafts Ethik, Gesundheit und Sicherheit, Arbeit.

#### UN Global Compact

ist offiziell Teil der Familie des UN Global Compact - der weltweit größten Initiative für Nachhaltigkeit von Unternehmen.

#### ECOVADIS

gold anerkennung  
Wurde mit dem Gold Anerkennungsgrad von Ecovadis Ausgezeichnet.

**Klimaneutrale websites:** Teil der neuen Nachhaltigkeitsinitiative in Zusammenarbeit mit dem Global Climate Institute.

#### IMPRIM' VERT

Qualifiziert durch IMPRIM' VERT. Ein Engagement für wirtschaftliche Drucktätigkeiten, die Auswirkungen ihrer Aktivitäten auf die Umwelt zu reduzieren.

#### Workplace Conditions Assessment

Wurde von Intertek als übereinstimmend mit den Konditionen von Workplace Condition Assessment eingeschätzt.

#### Our Awards

PSI Sustainability Awards / Zum dritten Mal in Folge 2017-2019  
2019 - 1. Platz Economic Excellence  
Basierend auf einem strikt strukturiertem Qualitätsmanagement System  
2017 - 1. Platz Economic Excellence  
1. Platz Sustainable products  
2018 - 1. Platz Social initiative  
3. Platz Environment initiative

## IT> Corporate social responsibility di BIC' Graphic

### ISO 9001 - ISO 14001

Certificazioni per il sistema di gestione integrata delle strutture di Tarragona da parte del Lloyd's Register.

#### I nostri prodotti certificati NF

La certificazione NF attesta la conformità dei prodotti e dei servizi alle normative nazionali, europee e internazionali.

#### Coca-Cola / Punteggio di 0 non conformità

Il social audit di Coca-Cola è stato superato con il massimo risultato in termini di conformità con gli standard lavorativi, di rispetto dei diritti umani, salute e sicurezza sul luogo di lavoro, gestione ambientale e integrità aziendale.

#### AMFORI

Membro dell'associazione leader mondiale per il commercio aperto e sostenibile. Raggruppa oltre 2.400 commercianti, importatori, brand e associazioni di oltre 40 Paesi.

#### Audit 4 pilastri SMETA

4 pilastri: ambiente, etica aziendale, salute e sicurezza, lavoro

#### UN Global Compact

Ufficialmente parte della famiglia UN Global Compact - la più grande iniziativa a livello mondiale per la sostenibilità aziendale.

#### ECOVADIS

Livello Gold recognition da parte di Ecovadis.

#### Siti web carbon neutral

Membri della nuova iniziativa per la sostenibilità in collaborazione con il Global Climate Institute.

#### IMPRIM' VERT

Qualificato da IMPRIM' VERT. Un impegno da parte delle aziende che operano nel settore della stampa a ridurre l'impatto ambientale delle loro attività.

#### Workplace conditions assesment

Certificato da Intertek conforme ai requisiti del Workplace Conditions Assessment

#### I nostri riconoscimenti

PSI Sustainability Awards / Per tre anni consecutivi 2017-2019  
2019 1° POSTO Economic Excellence. Basato su un sistema di gestione della qualità strutturato in modo rigido  
2017 1° POSTO Eccellenza economica. 1° POSTO Prodotti sostenibili  
2018 1° POSTO Iniziativa sociale.  
3° POSTO Iniziativa ambientale

# BIC® Graphic Corporate social responsibility



## **ISO 9001 - ISO 14001**

Integrated Management System Certifications for the Tarragona facilities from Lloyd's Register.



## **OUR NF CERTIFIED PRODUCTS:**

NF Certification attests to the conformity of products and services with national, European and international normative documents



## **SCORE OF 0 NON - CONFORMITIES**

Coca-Cola social audit passed with the maximum positive audit result in terms of compliance with Labour Standards & Human Rights, Health & Safety, Environmental Management and Business Integrity.



## **AMFORI:**

Member of the leading global business association for open and sustainable trade. They bring together over 2,400 retailers, importers, brands and associations from more than 40 countries.



## **SMETA 4-PILLAR AUDITED**

**4 Pillars:**  
Environmental, Business Ethics, Health & Safety, Labour



**United Nations Global Compact**

## **UN GLOBAL COMPACT**

Is officially part of the UN Global Compact family - **the world's largest corporate sustainability initiative.**



## **GOLD RECOGNITION**

Has been granted a Gold recognition level by Ecovadis.

## **CARBON NEUTRAL**



## **WEBSITES:**

Members of the a new sustainability initiative in collaboration with Global Climate Institute.



## **IMPRIM' VERT**

Qualified by IMPRIM'VERT. A commitment for printing activities business, to reduce the impact of their activity on the environment



**WORKPLACE CONDITIONS ASSESSMENT**

## **WORKPLACE**

Has been assessed by Intertek as conforming to the requirements of: **Workplace Conditions Assessment**



# Our Awards



## **FOR THREE YEARS IN A ROW 2017-2019**

### **2019**

**1<sup>st</sup> PLACE**  
Economic Excellence  
Based on a strictly structured quality management system

### **2017**

**1<sup>st</sup> PLACE**  
Economic Excellence  
**1<sup>st</sup> PLACE**  
Sustainable products

### **2018**

**1<sup>st</sup> PLACE**  
Social initiative  
**3<sup>rd</sup> PLACE**  
Environment initiative

**FR> La qualité qui fait la différence.**  
**Un atout stratégique**

La qualité et la sécurité constituent un actif stratégique et font partie de l'ADN du groupe BIC. La qualité des produits est révisé par des contrôles réguliers en ligne avec les réglementations et normes de la sécurité nationale et internationale. Des employés bien formés, un système de contrôle de qualité rigoureux et une logique d'amélioration continue de notre équipe de Recherche et Développement garantissent des produits BIC<sup>®</sup> de qualité élevée.

Articles de papeterie BIC<sup>®</sup>  
**7250 kilomètres** : la longueur des **tests d'écriture** réalisés en 2015 sur des lots de stylos à bille, stylos à encre gel et rollers.

Briquets BIC<sup>®</sup>

- Dans un site de production de briquets BIC<sup>®</sup>, un quart de la journée de travail d'un opérateur est consacré aux **contrôles de qualité**.
- Tous les briquets de poche BIC<sup>®</sup> sont **conformes ou dépassent les normes** et réglementations internationales. (**ISO 9994, EN13869**).

Rasoirs BIC<sup>®</sup>

- **30 contrôles différents** pour fabriquer un rasoir à 3, 4 ou 5 lames conforme aux normes de qualité strictes de BIC.
- Les trois sites de production des célèbres rasoirs BIC ont reçu **trois certifications** : **ISO 9001, ISO 14001 et OHSAS 18001**.

Impression

Nos encres sont conformes aux réglementations européennes.

- Chaque **technique d'impression** est validée après avoir passé **5 tests distincts** : Test d'adhérence, Test de résistance aux rayures (ISO 12137:11), Test d'abrasion, Test de résistance, Test d'exposition à la transpiration par simulation
- Chaque commande de produits **imprimés** passe **4 contrôles distincts** : Contrôle de l'esthétique, Contrôle de la couleur de l'impression, Contrôle de l'adhérence de l'impression, Résistance à la détérioration

**ES> La diferencia de la calidad.**  
**Un activo estratégico**

**La calidad y la seguridad** es un activo estratégico y forma parte del ADN del Grupo BIC. Su cualidad se comprueba en **múltiples controles** que respetan las **regulaciones y requerimientos de seguridad nacionales e internacionales**, un sistema de **control de calidad** riguroso enfocado en la **mejora continua** por el equipo de Búsqueda y Desarrollo, asegurando a BIC<sup>®</sup> que sus productos sean de la más alta calidad.

Productos de papelería BIC<sup>®</sup>  
**7250 kilómetros**, esa es la longitud de las pruebas de escritura llevadas a cabo en 2015 con varios lotes de bolígrafos, bolígrafos de gel y rollers.

Encendedores BIC<sup>®</sup>

- Los trabajadores de las fábricas de encendedores BIC<sup>®</sup> dedican una cuarta parte de su jornada a realizar **controles de calidad**.
- Todos los encendedores de bolsillo de BIC<sup>®</sup> cumplen o superan los estándares internacionales y los requerimientos regulatorios: ISO 9994, EN13869.

Maquinillas de afeitar BIC<sup>®</sup>

- **30** controles diferentes para que una maquinilla de afeitar de 3, 4 o 5 hojas cumpla con los estrictos estándares de calidad de BIC<sup>®</sup>.
- Las tres fábricas de producción de maquinillas de afeitar de BIC<sup>®</sup> han sido **triplemente certificadas**: **ISO 9001, ISO 14001 y OHSAS 18001**.

Impresión

Nuestras tintas cumplen con la normativa de la UE.

- **Control de impresión**: todas las técnicas de impresión se validan a través de **5 pruebas**: Prueba de adhesión, Prueba de arañazos (ISO 12137:11), Prueba de abrasión, Prueba de resistencia, Prueba de exposición a la transpiración artificial.
- Todos los pedidos de productos impresos pasan por **4 controles distintos**: Control de aspecto estético, Control de color de impresión, Control de la adherencia de impresión, Resistencia a los arañazos.

**DE> Der Qualitätsunterschied**  
**Eine strategische Anlage**

**Qualität und Sicherheit** sind eine strategische Anlage und Teil der DNA der BIC Gruppe. Die Qualität wird von **zahlreichen Kontrollen** überprüft, die nationale und **internationale Sicherheitsregulierungen und Anforderungen** respektieren. **Hervorragend ausgebildete Mitarbeiter**, ein rigoroses **Qualitäts Kontrollsystem** und der Fokus auf eine **kontinuierliche Verbesserung** von Seiten des Forschungs- und Entwicklungsteams garantieren BIC Produkte der höchsten Qualität.

BIC<sup>®</sup>-Schreibwaren  
**7.250 Kilometer** ist die Länge der Schreibtest, die 2015 bei Kugelschreibern, Gelschreibern und Rollerballs durchgeführt wurden.

BIC<sup>®</sup> lighters

- Ein Viertel eines Facharbeiter-Arbeitstages in einer BIC<sup>®</sup>-Feuerzeugfabrik ist den **Qualitätsprüfungen gewidmet**.
- Alle BIC<sup>®</sup>-Taschenfeuerzeuge erfüllen oder übertreffen internationale Standards und regulatorische Anforderungen. (ISO 9994, EN13869).

BIC<sup>®</sup>-rasierer

- **30** verschiedene Kontrollen, um einen 3-, 4- oder 5-Klingen-Rasierer herzustellen, der den strengen Qualitätsstandards von BIC entspricht.
- Mehrfach zertifiziert. BIC<sup>®</sup>'s drei Rasiererproduktionswerke sind dreifach zertifiziert: ISO 9001, ISO 14001 und OHSAS 18001.

Druck

Unsere Druckfarben entsprechen den EU-Vorschriften.

- **Alle Aufdrucktechniken** werden durch **5** verschiedene Tests validiert: Haftungstest, Kratztest (ISO 12137:11), Abriebtest, Falltest, Test mit Einwirkung von künstlichem Schweiß.
- Jede **Druckbestellung** durchläuft **4** verschiedene Kontrollen: Kontrolle der optischen Erscheinung, Aufdruckfarbkontrolle, Kontrolle der Haftung des Aufdrucks, Kratzfestigkeit

**IT> La differenza sta nella qualità.**  
**Un asset strategico**

**Qualità e sicurezza** rappresentano un asset strategico e fanno parte del DNA del Gruppo BIC. La qualità viene verificata attraverso **molteplici controlli** che rispettano **le normative e i requisiti internazionali in materia**. **Collaboratori ben formati**, un rigoroso sistema di **controllo della qualità** e un'attenzione al **miglioramento continuo** da parte del team di Ricerca e Sviluppo, garantiscono il massimo della qualità dei prodotti BIC<sup>®</sup>.

Prodotti di cancelleria BIC<sup>®</sup>  
7.250 km: questa la lunghezza dei test di scrittura effettuati nel 2015 su penne a sfera, penne gel e roller.

Accendini BIC<sup>®</sup>

- Un quarto della giornata lavorativa di un operatore in uno stabilimento che produce accendini BIC<sup>®</sup> è dedicato ai **controlli di qualità**.
- Tutti gli accendini tascabili BIC<sup>®</sup> **rispettano o superano gli standard internazionali e i requisiti normativi: ISO 9994, EN13869**.

Rasoio BIC<sup>®</sup>

- **30 diversi controlli** per ottenere dei rasoi a 3, 4 o 5 lame conformi ai più stringenti standard di qualità.
- I tre stabilimenti BIC<sup>®</sup> che producono rasoi hanno ottenuto una **trippla certificazione: ISO 9001, ISO 14001 e OHSAS 18001**.

Stampa

I nostri inchiostri sono conformi alle normative europee.

- **Test di stampa**: ogni tecnica di stampa viene validata attraverso **5 test differenti**: adesione, graffio (ISO 12137:11), abrasione, caduta, esposizione alla traspirazione.
- Ogni **ordine stampato** viene sottoposto a **4 differenti controlli**: aspetto estetico, colore stampato, controllo dell'aderenza della stampa, resistenza al graffio.



## A strategic asset



**Quality & safety** is a strategic asset and it's part of the DNA of the BIC Group. Product quality is checked by **multiple controls** that respect national and **international safety regulations and requirements**.

**Well-trained employees**, a rigorous **quality control** system and a focus on **continuous improvement** by the Research & Development team, ensure BIC® products are of the highest quality.



### BIC® STATIONERY PRODUCTS

**7,250 kilometers**, the length of **writing tests** carried out in 2015 on batches of ballpoint pens, gel pens and rollers.



### BIC® LIGHTERS

- One quarter of an operator's workday in a BIC® lighter factory is dedicated to **quality checks**.
- All BIC® pocket lighters **meet or exceed international standards** and regulatory requirements: **ISO 9994, EN13869**.



### BIC® SHAVERS

- **30 different controls** to make a 3, 4 or 5-blade shaver that conforms to BIC's stringent quality standards.
- BIC's three shaver production factories have been **triple-certified: ISO 9001, ISO 14001 and OHSAS 18001**.



### PRINTING

Our inks are compliant with the EU regulations.

- **Printing tests** : Every imprint technique is validated through **5 different tests**: Adhesion Test, Scratch test (ISO 12137:11), Abrasion Test, Tumble Test, Exposure to artificial perspiration test.
- Every **imprinted order** passes **4 different controls**: Cosmetic Appearance control, Imprint Colour control, Imprint adherence control, Resistance to scratching.

## FR> Nos avantages

Marque BIC®  
Votre nom sera associé à des produits de qualité. La marque BIC® est reconnue par 9 personnes sur 10 !

Gratuit !

- Coûts de préparation
- Maquettes virtuelles
- Préparation de bon à tirer
- Échantillons
- Apps et outils numériques
- Etc.

Sites web au bilan carbone neutre : nous prenons part à l'initiative de durabilité en collaboration avec le Global Climate Institute.

MIX & MATCH

Plus de 10.000 combinaisons possibles de coloris standards des attributs sans frais supplémentaires

Certificats ISO 9001 et ISO 14001

par Lloyd's Register, relatives aux systèmes de gestion intégrée pour les installations de Tarragone (Espagne)

Expertise en matière d'impression  
Plus de 50 ans d'expérience dans le domaine de l'impression

Durabilité  
D'électricité 100% renouvelable

Innovation  
Pionniers dans le domaine des technologies d'impression dernière génération

IMPRIM'VERT

Nous réduisons l'impact de leur activité sur l'environnement

Proche de nos clients

- Fabriqués et imprimés en Europe
- 100 % des instruments d'écriture BIC® et des briquets BIC® sont imprimés au sein de BIC Graphic Europe.

Digital tools  
[www.bicgraphic.eu](http://www.bicgraphic.eu)

Service d'impression en 48 heures gratuit !  
Plus de 100 produits !

Garantie stock  
Des centaines d'articles toujours en stock.

## ES> Nuestras ventajas

Marca BIC®  
Tu marca estará asociada a productos e calidad. La marca BIC® es reconocida por 9 de cada 10 personas.

Gratis

- Gastos fijos de impresión
- Muestras visuales
- Artes gráficas
- Muestras físicas
- Apps y herramientas digitales
- Y mucho más...

Carbon neutral website  
Somos miembros de la nueva iniciativa sostenible en colaboración con el Instituto del Clima Global.

MIX & MATCH

Más de 100.000 combinaciones de colores gratuitas para componentes estándar.

ISO 9001 - ISO 14001

Sistema integrado de gestión de certificaciones para las instalaciones de Tarragona de Lloyd's Register.

Experiencia en impresión  
Más de 50 años de experiencia en impresión.

Sostenibilidad  
100% energía renovable

Innovación  
Pioneros en las últimas tecnologías de impresión.

IMPRIM'VERT

Reduciendo el impacto de la actividad en el medio ambiente.

Cercanos a los clientes

- Fabricado e impreso en Europa
- 100% de los instrumentos de escritura BIC® y los encendedores BIC® están impresos en BIC Graphic Europe.

Herramientas digitales  
[www.bicgraphic.eu](http://www.bicgraphic.eu)

¡Servicio de impresión en 48 horas gratis!  
En más de 100 productos.

Promesa de inventario  
Cientos de artículos siempre en stock.

## DE> Unsere Vorteile

BIC®-MARKE  
Ihr Name wird mit Qualitätsprodukten assoziiert. 9 von 10 Personen kennen die Marke BIC®

Kostenlos

- Druckeinrichtungskosten
- Virtuelle Muster
- Graphik und Design
- Materialmuster
- Apps und Dialogue Tools
- Und vieles andere mehr...

Klimaneurale websites:  
Teil der Nachhaltigkeitsinitiative in Zusammenarbeit mit dem Global Climate Institute.

MIX & MATCH

Über 100.000 kostenlose Farbkombinationen bei den Standardkomponenten!

ISO 9001 - ISO 14001

zertifizierungen für integrierte Qualitäts- und Umweltmanagementsysteme für ihre Werke in Tarragona (Spanien) vom Lloyd's Register erhalten

Druck fachwissen  
Über 50 Jahre Druckerei Fachkenntnisse

Nachhaltigkeit  
100% Erneuerbare Energien

Innovation  
Pioniere in der neusten Druckerei Technologie

IMPRIM'VERT  
Die Auswirkungen auf die Umwelt reduzieren

- Nah an unseren Kunden
- Hergestellt und gedruckt in Europa
  - 100 % der BIC Schreibinstrumente und BIC Feuerzeuge werden bei BIC Graphic Europe gedruckt

Digital tools  
[www.bicgraphic.eu](http://www.bicgraphic.eu)

48-Stundendruckservice kostenlos!  
Für über 100 Produkte!

Lagerbestands-versprechen  
Hunderte von Artikeln immer am Lager

## IT> I nostri vantaggi

BRAND BIC®  
Il vostro nome sarà associato a prodotti di qualità. Il brand BIC® è riconosciuto da 9 persone su 10.

Liberi di scegliere

- Singola chiamata
- Aspetto visivo
- Prove di stampa
- Campioni
- App e strumenti digitali
- E molto altro...

Siti web carbon neutral:  
Parte della nostra iniziativa di sostenibilità in collaborazione con il Global Climate Institute.

MIX & MATCH

Oltre 100.000 combinazioni di colore gratuite per i componenti standard!

ISO 9001 - ISO 14001

Certificazioni relative al sistema di gestione integrata per il complesso di Tarragona da parte del Lloyd's Register.

Esperienza nella stampa  
Oltre 50 anni di esperienza di stampa.

Sostenibilità  
100% energia da fonti rinnovabili

Innovazione  
Pionieri nelle tecnologie di stampa più innovative

IMPRIM'VERT  
Riduzione dell'impatto ambientale della nostra attività

Vicini ai nostri clienti  
Prodotto e stampato in Europa. Il 100% degli strumenti di scrittura e degli accendini BIC® sono stampati presso BIC Graphic Europe.

Strumenti digitali  
[www.bicgraphic.eu](http://www.bicgraphic.eu)

Servizio di stampa in 48h gratuita!  
Su oltre 100 prodotti

Promesse di inventario  
Centinaia di articoli sempre disponibili.



# Our advantages

## BIC BRAND

Your name will be associated with quality products. The BIC® brand is recognised by 9 out of 10 people.

## FREE

- Set up charges
- Visuals
- Artwork proofs
- Physical samples
- Apps & digital tools
- And much more...



## CARBON NEUTRAL WEBSITES:

Part of the sustainability initiative in collaboration with Global Climate Institute.

## ISO 9001 - ISO 14001

Integrated Management System Certifications for the Tarragona facilities from Lloyd's Register.

## MIX & MATCH

Over 100,000 Free standard component colour combinations!

## PRINTING EXPERTISE

Over 50 years of printing expertise.

## INNOVATION

Pioneers in the latest printing technologies



## IMPRIM VERT

Reducing the impact of the activity on the environment

## DIGITAL TOOLS

[www.bicgraphic.eu](http://www.bicgraphic.eu)



## SUSTAINABILITY

100% renewable energy

## CLOSE TO OUR CUSTOMERS

- Manufactured & printed in Europe.
- 100% of BIC® Writing Instruments and BIC® Lighters are printed in BIC Graphic Europe.

## INVENTORY PROMISE

Hundreds of items always in stock.

## FREE 48H PRINTING SERVICE!

For over 100 products

---

**FR> La qualité qui fait la différence**  
**Techniques d'impression**

En tant que fournisseur international phare dans le secteur des produits promotionnels, notre objectif est de **faire de votre marque une marque emblématique** grâce à nos techniques d'impression et à nos finitions.

Sérigraphie (y compris les encres en relief et métalliques) /Tampographie/Impression numérique/Numérique britepix™/Gravure laser/britepix™/Doming/Marquage /à chaud/Texture britepix™/Gaufrage/Impression transfert/ Impression /relief 3D/Sublimation/Encre métallique/Fluorescent

À plus de 50 ans La garantie inhérente

**ES> La diferencia de la calidad**  
**Técnicas de impresión**

Como proveedor internacional y líder en la industria de productos promocionales, nuestra meta es **hacer que tu marca destaque** con nuestras técnicas de impresión y acabados.

Serigrafía (Incluye Puff & tintas metálicas)/Tampografía/ Impresión digital/britepix™ digital/Grabado láser/ britepix™/Gota de resina/Termograbado en color transparente/britepix™ texture/Termograbado/Transfer serigráfico/Impresión 3D en Puffy/Sublimación/Tinta metálica/Brilla en la oscuridad

iCon más de 50 años de experiencia como garantía!

---

**DE> Der Qualitätsunterschied**  
**Drucktechniken**

Als ein internationaler und führender Lieferant in der Werbeproduktindustrie, ist es unser Ziel **Ihre Marke hervorzuheben**, mit unseren Drucktechniken und mit unseren letzten Schritten

Siebdruck (einschließlich Puffy- und Metallic-Farben) /Tampondruck/Digitaldruck/britepix™ Digital/Lasergravur /britepix™/Doming/Heissprägung/Britepix™ Texture /Tiefprägung (Debossing)/Siebtransferdruck/3D-puffy-druck/Sublimation/Metallic-farbe/Glow in the Dark

Über 50 Jahre Garantierte Erfahrung!

**IT> La differenza sta nella qualità**  
**Tecniche di stampa**

In qualità di fornitori internazionali leader nel settore dei prodotti promozionali, il nostro obiettivo è quello di **far emergere il vostro brand** grazie alle nostre tecniche e alle nostre finiture di stampa.

Stampa da schermo (compresi inchiostri in rilievo e metallici)/Stampa a tampone/Stampa digitale/britepix™ digitale/Litografia laser/britepix™/Doming/Etichettatura a caldo/Tessuto Britepix™/Stampa a rilievo/Trasferimento da schermo/Stampa 3D in rilievo/Sublimazione/Inchiostro metallico/Effetto che illumina al buio

Con la garanzia di oltre 50 anni di esperienza!





## Printing techniques

As an international and leading supplier in the promotional products industry, our goal is to **make your brand stand out** with our printing techniques and finishes.



**Screen Printing**  
(Including Puffy & Metallic inks)



**Pad Printing**



**Digital Printing**



**britePix™ Digital**



**Laser Engraving**



**britePix™**



**Doming**



**Hot Stamping**



**britePix™ Texture**



**Debossing**



**Screen Transfer**



**3D Puffy Printing**



**Sublimation**



**Metallic Ink**



**Glow in the Dark**

**With more than  
50 years of  
experience  
as a guarantee!**



#### FR> Partner Brands

BIC Graphic Europe travaille main dans la main avec des marques reconnues qui garantissent des normes de haute qualité et un fort engagement des clients.

T'nB®

Depuis près de 30 ans, T'nB conçoit et vend des **accessoires intelligents** ancrés dans le quotidien de millions de consommateurs. Personnalisez-les !

Sprout™

Nous croyons fortement en la **durabilité** ! En plantant un crayon Sprout lorsqu'il touche à sa fin, vous pouvez sensibiliser les autres à la durabilité et les inspirer à apporter des changements à leur quotidien.

SKROSS®

SKROSS, **reconnue à l'échelle internationale** comme sûre, simple et Suisse : des solutions universelles de charge pour les globe-trotters.

#### ES> Partner brands

BIC Graphic Europa trabaja con marcas reconocidas que garantizan los estándares de alta calidad y el compromiso del consumidor.

T'nB®

Desde hace casi 30 años, T'nB ha diseñado y vendido **accesorios inteligentes** atados a las vidas diarias de millones de consumidores. Personalízalos!

Sprout™

¡Creemos en la **sostenibilidad** plantando un lápiz Sprout cuando está casi acabado! Puedes hacer visible la sostenibilidad a otros e inspirarlos a hacer cambios en la vida diaria.

SKROSS®

**Mundialmente reconocido** como seguro, simple y suizo: carga universal para los trotamundos.

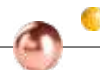

#### DE> Partnermarken

BIC Graphic Europe arbeitet mit anerkannten Marken die hohe Qualitätsstandards und Kundenengagement garantieren.

T'nB®

Für fast 30 Jahre hat T'nB **intelligente Accessoires** entworfen und verkauft, eingefügt im täglichen Leben von Millionen von Kunden. Personalisiere sie!

Sprout™

Wir glauben an **Nachhaltigkeit**! In dem Sie einen Sprout Bleistift pflanzen wenn er fast abgenutzt ist, können Sie Nachhaltigkeit sichtbar für andere machen und sie inspirieren Veränderungen in ihrem Alltag vorzunehmen. des changements à leur quotidien.

SKROSS®

SKROSS® - **global anerkannt und sicher**, einfach und Swiss: Universelle Aufladungsmöglichkeiten für Weltenbummler

#### IT> Brand partner

BIC Graphic Europe lavora con brand rinomati che garantiscono elevati standard di qualità ascoltando sempre le esigenze dei clienti.

T'nB®

Per quasi 30anni, T'nB ha progettato e venduto **accessori intelligenti** che fanno parte ormai della vita di milioni di consumatori. Prova a personalizzare i tuoi!

Sprout™

Noi crediamo nella **sostenibilità**! Piantando una matita Sprout quando è quasi finita potrai rendere visibile ad altri la sostenibilità e ispirarli a cambiare le proprie abitudini quotidiane.

SKROSS®

SKROSS® - **sinonimo in tutto il mondo di sicurezza**, semplicità e Svizzera: possibilità di carica universale per chi è sempre in giro per il mondo.



# Partner Brands

BIC Graphic Europe works with recognised brands that guarantee high quality standards and Customer engagement.

---

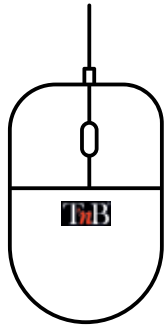

**T'nB\***

For almost 30 years, T'nB has been designing and selling **intelligent accessories** anchored in the daily lives of millions of consumers. Personalise them!

**Sprout™**



We believe in **sustainability!** By planting a Sprout pencil when it's almost finished, you can make sustainability visible to others, and inspire them to make changes in their daily life.

**SKROSS\***

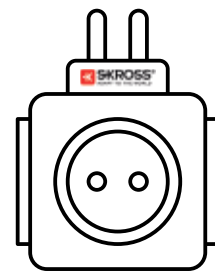

SKROSS\* - **globally renowned as safe,** simple and Swiss: universal charging possibilities for globetrotters.

## FR> Digital tools

Les APPS BIC Graphic Europe, vos partenaires où que vous soyez.

Notre but est votre plus grande satisfaction lorsque vous réalisez un projet avec nos produits. C'est la raison pour laquelle **nos outils sont faits pour vous aider !**

L'APP BIC Graphic Catalogue  
BIC Graphic Catalogue est un outil unique permettant d'accéder à toutes les informations (informations techniques et de l'entreprise, images des produits, prix et bien plus).

Créez vos propres notes et configurez également vos préférences d'affichage.

L'APP BIC Graphic

- Vivez une expérience incroyable de réalité augmentée avec des effets surprenants
- Jouez avec le configurateur produit 3d pour sélectionner votre choix de combinaisons de couleurs
- Téléchargez votre logo
- Regardez les vidéos des produits bic® les plus iconiques
- Customisez vos images avec le service de personnalisation

Scannez cet icône sur les pages de produits avec notre app et vous pourrez voir les produits prendre vie !

## ES> Digital tools

BIC Graphic Europe APPS, tu compañero en cualquier lugar

Nuestro objetivo es darte la mejor satisfacción cuando haces un proyecto con nuestros productos.

iPos eso nuestra herramientas están hechas para ayudarte!

BIC Graphic Catalogue APP

El catálogo de BIC Graphic es una herramienta única para acceder a toda la información (corporativa y técnica, imágenes de producto, precios y más).

Crema tus propias notas y configúralas viendo las preferencias.

BIC GRAPHIC APP

- Vive una experiencia increíble de realidad aumentada con efectos sorprendentes.
- Juega con el configurador de producto 3D para seleccionar tu combinación de color.
- Mira videos de producto con el servicio de personalización.
- Personaliza tus imágenes con el servicio de personalización.
- Sube tu logo.

Escanea el icono en las páginas de producto con tu app y iverás que el producto está vivo!

## DE> Digitale Werkzeuge

Dein Partner überall

Unser Ziel ist es Ihnen die bestmögliche Zufriedenheit zu gewährleisten wenn Sie ein Projekt mit unseren Produkten erstellen. Deshalb sind unsere Werkzeuge gemacht um Ihnen zu helfen!

BIC Graphic Katalog APP

BIC Graphic Katalog ist ein einzigartiges Werkzeug um auf alle Informationen zuzugreifen (Unternehmens und Technische Information, Produkt Fotos, Preise und vieles mehr). Kreiere deine eigenen Notizen und stelle deine Ansichtseinstellungen ein.

BIC Graphic App

- Erleben Sie eine unglaubliche Erfahrung der "erweiterten Realität" mit überraschenden Effekten
- Spielen Sie mit dem 3D-Produktkonfigurator um ihre gewünschte Farbkombination auszuwählen
- Laden Sie ihr Logo hoch
- Sehen Sie sich die Produktvideos der kultigsten BIC®-produkte an
- Passen Sie ihre Fotos mit dem Personalisierungsservice an

Scannen Sie dieses Symbol auf der Produktseite mit unserer App und Sie werden sehen, dass das Produkt zum Leben erwacht

## IT> Strumenti digitali

Le APP BIC Graphic Europe, tue alleate ovunque ti trovi

Il nostro obiettivo è di darti il massimo della soddisfazione quando lavori ai tuoi progetti utilizzando i nostri prodotti. Ecco perché i nostri strumenti sono fatti per aiutarti!

L'APP BIC Graphic Catalogue

BIC Graphic Catalogue è uno strumento unico che ti permette di accedere a tutte le informazioni (informazioni aziendali e tecniche, immagini di prodotto, prezzi e molto altro).

Crema i tuoi appunti: potrai anche configurare le tue preferenze di visualizzazione.

APP BIC Graphic

- Vivi un'esperienza incredibile grazie alla realtà aumentata e ai suoi effetti sorprendenti
- Divertiti con il configuratore 3D e seleziona la tua selezione preferita di colori
- Guarda i video dedicati ai prodotti BIC® più iconici
- Personalizza le tue immagini grazie al servizio dedicato
- Carica il tuo logo

Scansiona questa icona sulle pagine prodotto con l'app e vedrai il prodotto prendere vita!



## BIC Graphic Europe APPS, your partner everywhere



Our goal is to give you the best satisfaction when you use our products for your project.

That's why our tools are made to help you!

### BIC GRAPHIC CATALOGUE APP

BIC Graphic Catalogue is a unique tool to access all information (corporate & technical information, product images, prices and much more).

Create your own notes and you can also configure your viewing preferences.



Scan this icon on the product pages with our app and you'll see that the product comes to life!



### BIC GRAPHIC APP

- **Live** an incredible experience of augmented reality with surprising effects
- **Play around** with the 3D product configurator to select your chosen colour combination
- **Watch** product videos of the most iconic BIC® products
- **Customise** your images with the personalization service
- **Upload** your logo



## FR> Boutique en ligne

Complétez l'information produit :  
détails produits et images, disponibilité du stock, prix, possibilités d'impression, packaging et les outils multimedia.

3% de remise  
Obtenez 3% de remise sur chaque commande en ligne.

Prix tout inclus :  
facile, un prix avec tout inclus : frais techniques, impression et coût de transport.

E-cotation :  
les conditions tarifaires avec toutes les informations requises avec votre logo en un seul click !

Configurateur produit :  
configurateur 2D et 3D pour tous les produits. Téléchargez votre logo et obtenez une maquette virtuelle.

Besoin d'un site internet ?  
Construction facile de votre propre site internet basé sur notre modèle, gratuitement !

Sites web au bilan carbone neutre :  
nous prenons part à l'initiative de durabilité en collaboration avec Global Climate Institute.

Saisissez vos commandes rapidement et facilement!

Commande en ligne :  
processus de commande complet, une vue des commandes en cours ou passées, les attentes d'accord sur les fiches de marquage et les factures, etc.

Assistance en ligne : chat en direct

## ES> Tienda online

Información de producto completa  
Detalles de producto e imágenes, disponibilidad de stock, precio, posibilidades de impresión, packaging y herramientas multimedia.

3% OFF  
Obten un 3% de descuento al hacer tu pedido a través de nuestra web.

Todo incluido en el precio  
Fácil, un precio con todo incluido: gastos fijos, impresión y costes de transporte.

E-presupuesto  
Toda la información requerida con tu propio logo y condiciones de precio icon un solo click!

Configurador de producto  
Configurador 2D y 3D para todos los items. Sube tu logo y obten una muestra visual gratis.

¿Necesitas una web?  
Construye tu web basada en nuestro modelo fácilmente y gratis!

Carbon neutral websites:  
Somos parte de la iniciativa de sostenibilidad en colaboración con el Instituto del Clima Global.

Haz tu pedido más fácil y rápido

Pedidos online  
Completa el proceso del pedido, haz un vistazo general de los pedidos actuales y pasados, las aprobaciones de artworks pendientes y facturas, etc.

Asistencia online: chat en directo.

## DE> Online shop

Vollständige Produktinformation:  
Produktdetails und -fotos, Lagerverfügbarkeit, Preis, Druckmöglichkeiten, Verpackung und Multimedia Tools.

3% Rabatt  
Erhalten Sie 3 % Rabatt, wenn Sie ihre Bestellung auf unserer Website tätigen

All-inklusive-Preis:  
einfach, ein Preis inklusive aller Extras: Einrichtungskosten, Druck- und Transportkosten.

E-Angebot:  
alle benötigten Informationen inklusive Ihres eigenen Logos und Preiskonditionen mit nur einem Klick!

Produktkonfigurator:  
2D- und 3D- Konfigurator für alle Artikel. Laden Sie Ihr Logo hoch und erhalten Sie ein kostenloses virtuelles Muster.

Sie benötigen eine Website?  
Erstellen Sie sich Ihre eigene Website, basierend auf unserem kostenlosen Modell!

Klimaneutrale websites:  
Wir sind Teil der Nachhaltigkeitsinitiative in Zusammenarbeit mit dem Global Climate Institute.

Platzieren sie ihre bestellungenschneller Und einfacher!

Online-Bestellungen:  
vollständige Bestellabwicklung, Überblick über aktuelle und frühere Bestellungen, anstehende Druckvorlagen, Freigaben und Rechnungen etc.

Online-Assistenz: Live-Chat

## IT> Shop online

Informazioni complete sul prodotto:  
dettagli e immagini di prodotto, disponibilità in magazzino, prezzo, possibilità di stampa, imballaggio e strumenti multimediali

3% di sconto  
Ordinando sul nostro sito avrai subito uno sconto del 3%

Prezzo tutto incluso:  
Semplice, un solo prezzo che include: predisposizione, stampa e spese di trasporto.

Preventivo online:  
Tutte le informazioni richieste con il tuo logo e i dettagli relativi al prezzo, tutto in un solo clic!

Configuratore prodotto:  
Configuratore 2D e 3D per tutti gli articoli. Carica il tuo logo e visualizza un'anteprima gratuita.

Serve un sito web?  
Crea in pochi passi e gratuitamente il tuo sito web basato sul tuo modello!

Siti web carbon neutral:  
Siamo parte di questa iniziativa dedicata alla sostenibilità in collaborazione con il Global Climate Institute.

Crea i tuoi ordini in modo facile e veloce

Ordini online:  
Procedura d'ordine completa, riepilogo degli ordini in corso e passati, approvazione grafica e fatture in sospeso ecc.

Assistenza online: live chat



# Online shop

[www.bicgraphic.eu](http://www.bicgraphic.eu)



## COMPLETE PRODUCT INFORMATION:

product details and images, stock availability, price, printing possibilities, packaging and multimedia tools

## PRODUCT CONFIGURATOR:

2D and 3D configurator for all items. Upload your logo and get a free visual.

## NEED A WEBSITE?

Easily build your own website based on our own model for free!



## CARBON NEUTRAL WEBSITES:

We are part of the sustainability initiative in collaboration with Global Climate Institute.



**Online assistance:**  
live chat

## 3% OFF

Get a 3% off when placing your order on our website

## ALL INCLUSIVE PRICE:

Easy, one price with everything included: set up charges, printing & transport costs.

## E-QUOTATION:

All the information required with your own logo and pricing conditions with just one click!

## PLACE YOUR ORDERS FASTER & EASIER

## ONLINE ORDERS:

Complete order processing, overview of current and past orders, pending artwork approvals and invoices, etc.

# Table of contents

<b><u>BIC® WRITING INSTRUMENTS</u></b>	<b><u>BIC® STICKY NOTES</u></b>
<b>46</b> BALLPENS <b>118</b> METALLIC PENS <b>124</b> ROLLERS & GELS <b>136</b> HIGHLIGHTERS & MARKERS <b>146</b> PENCILS <b>158</b> SPROUT PENCIL <b>162</b> COLOURING PENS <b>172</b> CORRECTION	<b>188</b> ADHESIVE NOTEPADS <b>206</b> SCRATCH PADS <b>208</b> BOOKLETS
<b><u>OTHER WRITING INSTRUMENTS</u></b>	<b><u>BIC® NOTEBOOKS</u></b>
<b>176</b> PLASTIC PENS <b>184</b> STYLUS PENS	<b>228</b> NOTEBOOKS

<p><b>BIC® LIGHTER &amp; CASES</b></p>	<p><b>TECHNOLOGY</b></p>
<p><b>236</b> LIGHTERS <b>264</b> LIGHTER CASES <b>269</b> OTHER PRODUCTS</p>	<p><b>296</b> TECHNOLOGY <b>297</b> T'NB <b>302</b> SKROSS</p>
<p><b>BIC® SHAVERS</b></p>	<p><b>BIC® PACKAGING</b></p>
<p><b>274</b> FOR MEN <b>280</b> FOR WOMEN</p>	<p><b>306</b> WRITING INSTRUMENTS SPECIAL PACKAGING <b>310</b> LIGHTERS SPECIAL PACKAGING</p>
<p><b>BIC® BAGS</b></p>	<p><b>GENERAL INFORMATION</b></p>
<p><b>288</b> BACKPACKS <b>292</b> ACCESSORIES</p>	<p><b>312</b> MAKE IT SIMPLE <b>314</b> 48-HOUR PRINTING SERVICE <b>316</b> STICKY NOTES <b>318</b> SYMBOLS &amp; ABBREVIATIONS <b>320</b> GENERAL INFORMATION <b>322</b> TECHNICAL PARAMETERS FOR EACH TYPE OF PRINTING <b>324</b> PRODUCT INDEX <b>325</b> COLOUR TABLE</p>

<p><b><u>BALLPENS</u></b></p> <p><b>46</b> BIC® Style</p> <p><b>50</b> BIC® Round Stic</p> <p><b>54</b> BIC® M10 Clic</p> <p><b>58</b> BIC® Media Clic</p> <p><b>62</b> BIC® Media Clic Grip</p> <p><b>66</b> BIC® Media Clic Shine</p> <p><b>68</b> BIC® Media Clic Bio Ecolutions</p> <p><b>72</b> BIC® Clic Stic</p> <p><b>82</b> BIC® Super Clip</p> <p><b>86</b> BIC® Super Clip Advance</p> <p><b>92</b> BIC® Wide Body</p> <p><b>94</b> BIC® Wide Body Chrome</p> <p><b>100</b> BIC® Atlantis</p> <p><b>104</b> BIC® 4 Colours</p> <p><b>108</b> BIC® 4 Colours Mini</p> <p><b>109</b> BIC® 4 Colours Sun</p> <p><b>110</b> BIC® 4 Colours Fashion</p> <p><b>112</b> BIC® 4 Colours Shine</p> <p><b>114</b> BIC® 4 Colours Fine</p> <p><b>115</b> BIC® 4 Colours Fluo</p> <p><b>116</b> BIC® 4 Colours Stylus</p> <p><b>117</b> BIC® 4 Colours 3+1</p>	<p><b><u>ROLLER &amp; GELS</u></b></p> <p><b>126</b> BIC® Grip Roller</p> <p><b>128</b> BIC® XS Finestyle</p> <p><b>131</b> BIC® Atlantis Gel</p> <p><b>132</b> BIC® GeI-Ocity Illusion</p> <p><b>134</b> BIC® Intensity Gel Clic</p>	<p><b><u>SPROUT</u></b></p> <p><b>159</b> Sprout</p>
<p><b><u>METALLIC PENS</u></b></p> <p><b>120</b> BIC® Metal Pro</p>	<p><b><u>HIGHLIGHTERS &amp; MARKERS</u></b></p> <p><b>138</b> BIC® Brite Liner Grip</p> <p><b>142</b> BIC® Velleda White Board Marker Fine</p> <p><b>143</b> BIC® Velleda White Board Marker Grip</p> <p><b>144</b> BIC® Mark-It Permanent Marker</p> <p><b>145</b> BIC® Permanent Marker Ecolutions</p>	<p><b><u>COLOURING PENS</u></b></p> <p><b>164</b> BIC® Plastidecor Set of 6 Crayons</p> <p><b>165</b> BIC® Evolution Ecolutions Set of 6 Colouring Pencils</p> <p><b>166</b> CONTE Set of 6 Colouring Pencils</p> <p><b>167</b> BIC® Colouring Set</p> <p><b>170</b> CONTE by BIC® Colouring Set</p>
	<p><b><u>PENCILS</u></b></p> <p><b>148</b> BIC® Matic</p> <p><b>153</b> BIC® Evolution Ecolutions</p>	<p><b><u>CORRECTION</u></b></p> <p><b>173</b> TIPP-EX Mini Pocket Mouse BritePix</p>



**BIC**® Writing  
instruments

44 — 173



**BIC® STYLE**  
Opaque - 1610



01/01    01/03    01/05    01/04    01/02    02/02



Colour ink  
Encre de couleur  
Color de la tinta  
Schreibfarbe  
Colore inchiostro

*New colours!*



10    03    14    13    04



12



100%



## MOQ 500u.

### Decoration:

Personnalisation / Personalización / Dekoration / Decorazione

#### BIC® STYLE

1610

**A SP:** max. 2 col.

#### BIC® STYLE CLEAR

1610

**B SP:** max. 1 col.

Clear - 1610

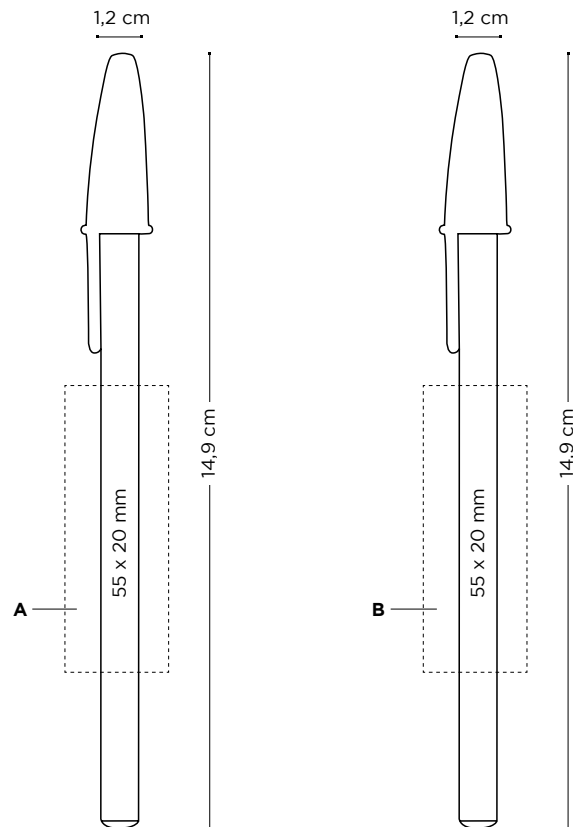

	Price (€)					
BIC® STYLE / BIC® STYLE CLEAR	500-999	1000-2499	2500-4999	5000-9999	10000-24999	25000-49999
1610						
<b>SP</b>	0,43	0,39	0,37	0,35	①	①

**Additional imprint charge per colour & position** Frais d'impression supplémentaires par couleur et position / Cargo por impresión adicional por color y posición / Zusätzliche druckkosten pro farbe & position / I prezzi includono la serigrafia ad 1 colore in una posizione.

<b>SP</b>	0,13	0,13	0,13	0,12	①	①
-----------	------	------	------	------	---	---

**Prices include 1 colour screenprint in one position.** Les prix incluent la sérigraphie 1 couleur sur un emplacement. En precio incluye un color en serigrafia en una posición. In den Preisen inbegriffen ist 1 Siebdruck-Farbaufdruck auf 1 Position. I prezzi includono 1 colore a serigrafia in una posizione.

① Price under request. Prix sur demande. Precio bajo consulta. Preis auf Anfrage. Prezzi su richiesta.

### Writing modes:

Mode écriture / Modos de escritura / Schreibmodi / Modalità di scrittura

Ballpen



M

### Printing techniques:

Techniques d'impression / Técnicas de impresión / Drucktechniken / Tecniche di stampa



(SP) SCREEN PRINTING

### New optional special packaging:

Nouvel emballage spécial en option / Nuevo envasado especial opcional / Neue optionale Verpackung / Nuove confezioni speciali opzionali



ECO Sleeve / Plastic Pouch  
+ INFO pag. 306

### External packaging:

Emballage externe / Envasado exterior / Außenverpackung / Imballaggio esterno



500 ± 3,5 Kg

[www.bicgraphic.eu](http://www.bicgraphic.eu)





The iconic BIC® Round Stic® offers timeless style and high quality. Its classic design is easy to identify and symbolises long-term reliability.

FR > L'icône BIC® Round Stic® offre un style in démodable et une très grande qualité. Son design classique est facile à identifier et symbolise une fiabilité à long terme.

ES > El icónico BIC® Round Stic® ofrece un estilo atemporal y de calidad. Su diseño clásico se identifica fácilmente y simboliza la fiabilidad a largo plazo.

DE > Unser kultiger BIC® Round Stic® bietet zeitloses Design in hoher Qualität. Sein klassisches Design ist einfach zu erkennen und steht für lang anhaltende Zuverlässigkeit.

IT > L'iconica BIC® Round Stic offre uno stile intramontabile ed alta qualità. Il suo design classico la rende facilmente riconoscibile ed è prova di una longeva affidabilità.





Opaque - 1010

Frosted - 1010

Iconic BIC® Boy is embossed

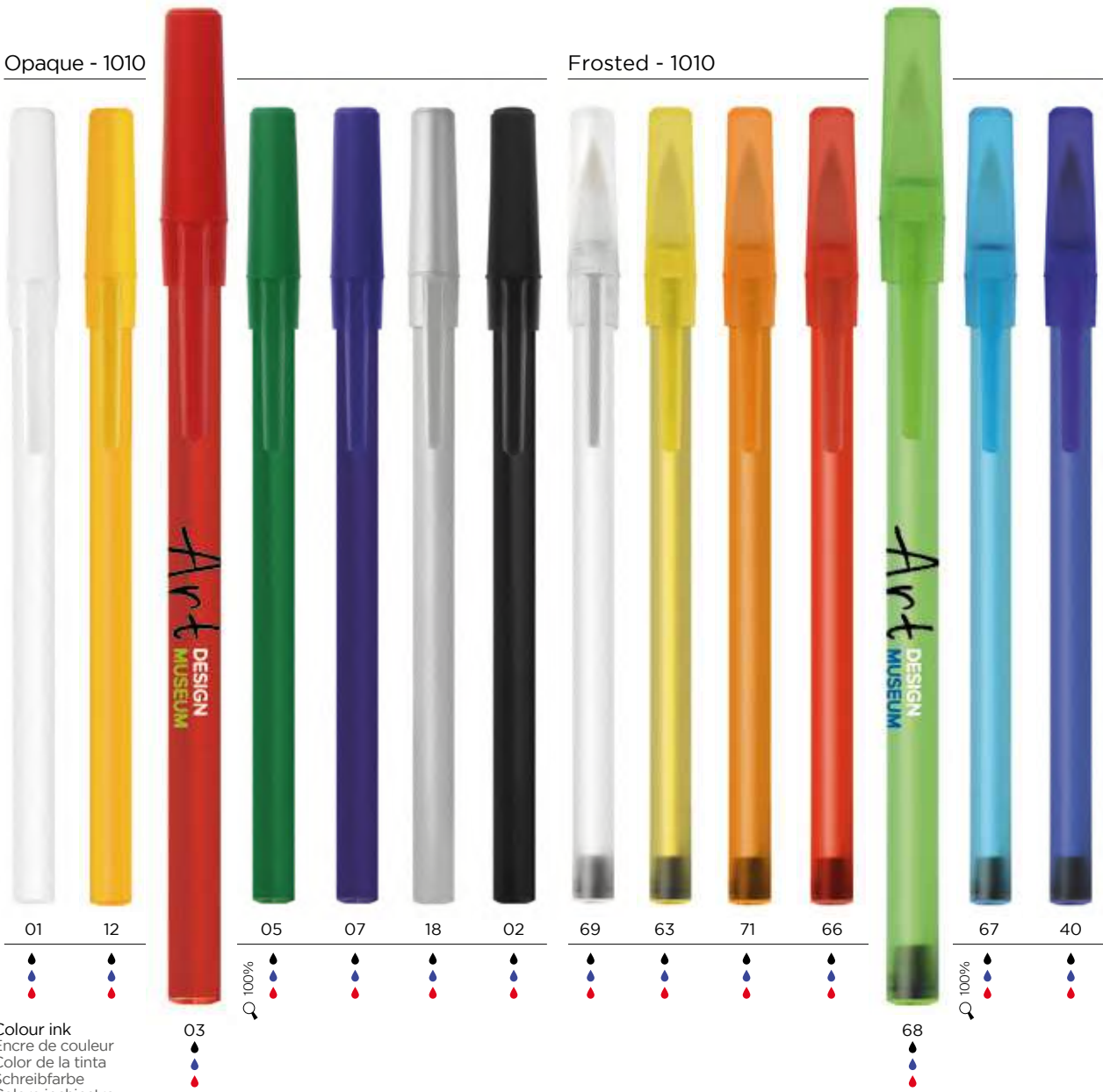

Colour ink  
Encre de couleur  
Color de la tinta  
Schreibfarbe  
Colore inchiostro

Red Ink available under request  
Encre rouge disponible sur demande  
Tinta roja bajo consulta  
Rote Tinte auf Anfrage erhältlich  
Inchiostro rosso disponibile su richiesta



\*\*48h not available in Digital finishes 48h non disponibile en impression numérique / \*48h no disponible en acabados digitales/ 48h bei digitalen Ausführungen nicht erhältlich / \*48h non disponibile in finiture digitale



MADE FROM 94% OF  
RECYCLED MATERIAL\* &  
100% RECYCLABLE

**ecolutions®**  
Opaque - 1E10



1E/8E

1E/7E

1E/10E



**ecolutions®**  
Frosted - 1E10



1E/3E

2E/8E

2E/7E

2E/10E



\*The percentage is calculated on total weight of product excluding cartridge  
 \*Pourcentage calculé sur le poids total du produit en excluant le cartouche  
 \*Porcentaje calculado a partir del peso total del producto excluyendo el cartucho  
 \*Der Prozentsatz bezieht sich auf das Gesamtgewicht des Produkts ohne Patrone  
 \*La percentuale è calcolata sul peso totale del prodotto refill escluso

Digital Printing!

**BIC® ROUND STIC® DIGITAL**  
**ecolutions®**  
VERSION AVAILABLE  
Opaque - 1010/1E10



1E/10E

01

available in white barrel  
 disponible en corps blanc  
 disponible en cuerpo blanco  
 mit weißem schaft erhältlich  
 disponibile in fusto bianco

**MOQ 500u.**

**Standard colours combination**

Combinaison de couleurs standards / Combinación de colores estandar / Standardfarbkombination / Combinazione colori standard

**Plug**

Bouton / Botón / Endstück / Pulsante

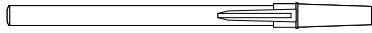

OPAQUE 01 12 10 03 05 20 04 07 18 02 FROSTED 69 63 71 66 68 67 40

**Clip**

Clip / Clip / Clip / Clip

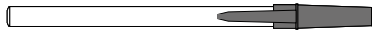

OPAQUE 01 12 10 03 05 20 04 07 18 02 FROSTED 69 63 71 66 68 67 40

**Section**

Section / Sección / Teil / Sezione

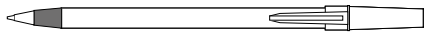

OPAQUE 01 12 10 03 05 20 04 07 18 02 FROSTED 69 63 71 66 68 67 40

**Barrel**

Corps / Cuerpo / Schaft / Fusto



OPAQUE 01 12 03 05 07 18 02 FROSTED 69 63 71 66 68 67 40

**ecolutions®** Standard colours combination

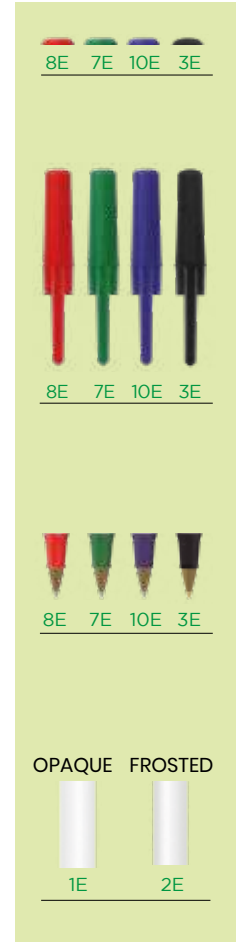

**Exact colour match:**

Correspondance exacte des couleurs / Color exacto / Exakte Farbübereinstimmung / Esatta corrispondenza di colore

≥ 10.000 units

FR > Ajoutez la boucle Möbius sur votre BAT sans frais additionnel. Merci de le préciser dans votre bon de commande (en bas à gauche par défaut)

ES > Añade el Möbius loop a tu arte final sin cargo adicional. Por favor asegúrate de especificarlo en tu pedido. (La impresión del Möbius loop a mano izquierda en la esquina).

Add the Möbius loop to your artwork at no additional charge. Please specify it on your order. (Möbius loop imprint defaults to left-hand hand corner.)

DE > Auf Wunsch können wir ihre Grafik ohne Zusatzkosten mit einer Möbiusband-Prägung versehen. Bitte geben Sie diesen Wunsch bei der Bestellung an. (Die Möbiusband-Prägung wird standardmäßig in der linken Ecke platziert.)

IT > Aggiungi il Mobius loop alla tua grafica senza costi addizionali. Si prega di specificarlo nell'ordine. La stampa del Mobius loop viene fatta di default per destrorsi nell'angolo destro.

**Writing modes:**

Mode écriture / Modos de escritura / Schreibmodi / Modalità di scrittura

Ballpen



M

**Printing techniques:**

Techniques d'impression / Técnicas de impresión / Drucktechniken / Tecniche di stampa



(SP) SCREEN PRINTING



(DG) DIGITAL

**New optional special packaging:**

Nouvel emballage spécial en option / Nuevo envasado especial opcional / Neue optionale Verpackung / Nuove confezioni speciali opzionali



ECO Sleeve / Plastic Pouch

**External packaging:**

Emballage externe / Envasado exterior / Außenverpackung / Imballaggio esterno



500 ± 2,5 Kg



MADE IN SPAIN

+ INFO pag. 306

**Decoration:**

Personnalisation / Personalización / Dekoration / Decorazione

**BIC® ROUND STIC®**

1010

©©olutions® 1E10

**A SP:** max. 3 col.

**B SP:** max. 1 col.

**C DG:** full-colour (available in white barrel)

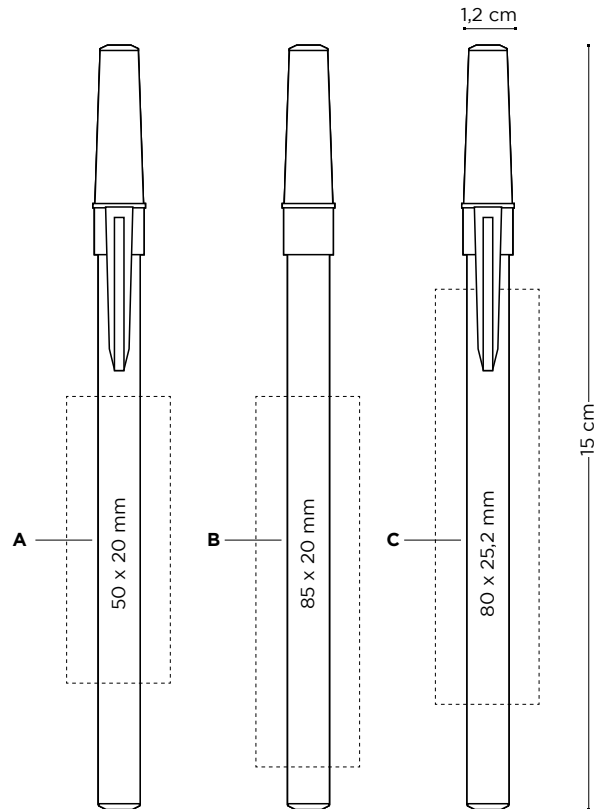

	Price (€)					
BIC® ROUND STIC®	500-999	1000-2499	2500-4999	5000-9999	10000-24999	25000-49999
1010 / ©©olutions® 1E10						
<b>SP</b>	0,50	0,48	0,45	0,42	0,39	0,36
<b>DG</b>	0,69	0,66	0,62	0,58	①	①

**Additional imprint charge per colour & position** Frais d'impression supplémentaires par couleur et position / Cargo por impresión adicional por color y posición / Zusätzliche druckkosten pro farbe & position / I prezzi includono la serigrafia ad 1 colore in una posizione.

<b>SP</b>	0,13	0,13	0,13	0,12	0,11	0,11
-----------	------	------	------	------	------	------

**Prices include one imprint in one position according to specified technique.** Les prix incluent une impression sur un emplacement avec la technique spécifiée / Los precios incluyen una impresión en una posición acorde con la técnica especificada / In den Preisen inbegriffen ist ein Aufdruck auf einer Position gemäß angegebener Technik / I prezzi includono una stampa in una posizione a seconda della tecnica specificata.

① Price under request. Prix sur demande. Precio bajo consulta. Preis auf Anfrage. Prezzi su richiesta.



**BIC® M10® CLIC**  
1590



Iconic BIC® Boy  
is embossed

Side push  
button



01

8G

10

14

59

3D

04

02

Colour ink  
Encre de couleur  
Color de la tinta  
Schreibfarbe  
Colore inchiostro

FR > Bouton-poussoir latéral

ES > Botón pulsador lateral

DE > Seitlicher Druckknopf

IT > Pulsante laterale a pressione





## MOQ 500u.

### Decoration:

Personnalisation / Personalización / Dekoration / Decorazione

### BIC® M10® CLIC

1590

A SP: max. 2 col.

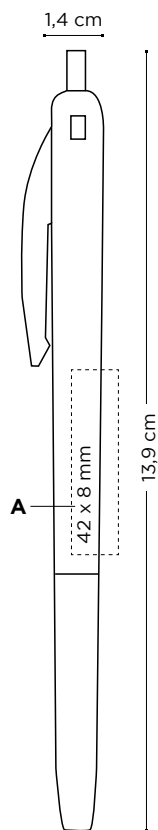

	Price (€)					
BIC® M10® CLIC	500-999	1000-2499	2500-4999	5000-9999	10000-24999	25000-49999
1590						
SP	0,52	0,50	0,47	0,44	0,41	0,37

**Additional imprint charge per colour & position** Frais d'impression supplémentaires par couleur et position / Cargo por impresión adicional por color y posición / Zusätzliche druckkosten pro farbe & position / I prezzi includono la serigrafia ad 1 colore in una posizione.

SP	0,13	0,13	0,13	0,12	0,11	0,11
----	------	------	------	------	------	------

**Prices include 1 colour screenprint in one position.** Les prix incluent la sérigraphie 1 couleur sur un emplacement. En precio incluye un color en serigrafia en una posición. In den Preisen inbegriffen ist 1 Siebdruck-Farbaufdruck auf 1 Position. I prezzi includono 1 colore a serigrafia in una posizione.

① Price under request. Prix sur demande. Precio bajo consulta. Preis auf Anfrage. Prezzi su richiesta.

### Writing modes:

Mode écriture / Modos de escritura / Schreibmodi / Modalità di scrittura



M

### Printing techniques:

Techniques d'impression / Técnicas de impresión / Drucktechniken / Tecniche di stampa



(SP) SCREEN PRINTING

### New optional special packaging:

Nouvel emballage spécial en option / Nuevo envasado especial opcional / Neue optionale Verpackung / Nuove confezioni speciali opzionali



ECO Sleeve / Plastic Pouch / Window Box + INFO pag. 306

### External packaging:

Emballage externe / Envasado exterior / Außenverpackung / Imballaggio esterno



1000 ± 8 Kg

### Check out the video

Regardez la vidéo / Mira el vídeo / Produktvideo / Guarda il video



www.bicgraphic.eu

55



One of the best seller in the industry, functional and already recognized design, our BIC® Media Clic is a long lasting product available in different materials, choose between the Standard, Recycled and BIO Version. Be inspire with the wide range of finishes and colours using them as a perfect match for enhance your brand.

FR > Un de nos best-sellers, design fonctionnel et reconnu, notre BIC Media Clic est un produit durable, disponible dans différents matériaux, vous pouvez choisir entre standard, recyclé et BIO. Laissez-vous porter par la vaste gamme de couleurs et finitions afin de trouver l'équilibre juste pour votre marque.

DE > Unser kultiger BIC® Round Stic® bietet zeitloses Design in hoher Qualität. Sein klassisches Design ist einfach zu erkennen und steht für lang anhaltende Zuverlässigkeit.

ES > Uno de los mejores vendidos en la industria, funcional y con diseño ya reconocido, nuestro BIC® Media Clic es un producto de larga duración disponible en diferentes materiales, escoge entre el Standard y la versión Reciclable y BIO. Inspírate con la amplia gama de acabados y colores usándolos como una perfecta combinación para realizar tu marca.

IT > Uno dei prodotti più venduti, funzionale e dal riconosciuto design, la nostra BIC Media Clic è durevole e disponibile in differenti materiali, sceglia tra le versioni Standard, Riciclato e BIO. Fatti ispirare dall'ampia gamma di colori e finiture combinandole perfettamente per enfatizzare il tuo marchio.



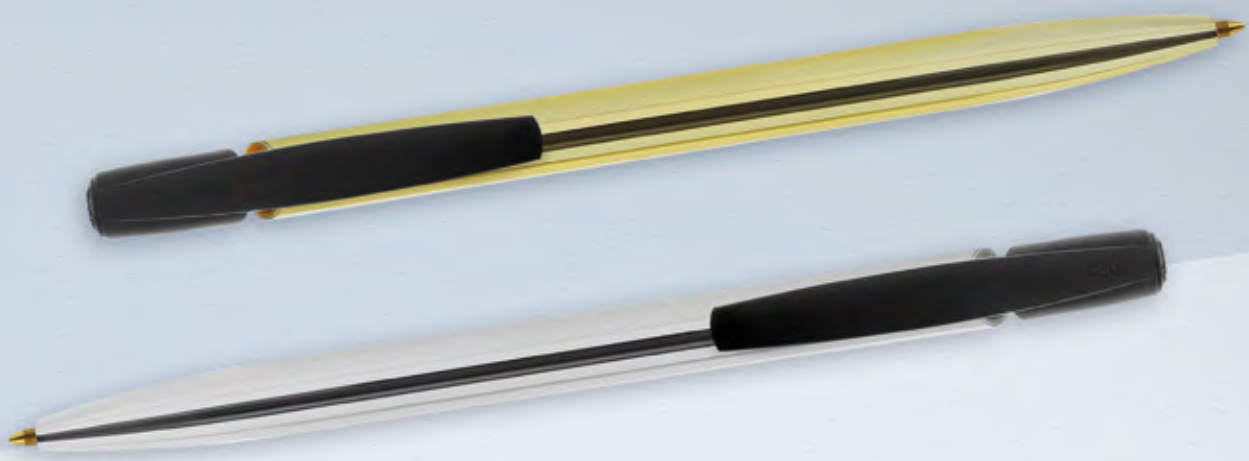



Polished Ballpen - 1025



Iconic BIC® Boy is embossed



1T

8T

6P

3T

6T

9T

5P

5T

4T

7T

8L

2T

Colour ink  
Encre de couleur  
Color de la tinta  
Schreibfarbe  
Colore inchiostro

Red Ink available under request  
Encre rouge disponible sur demande  
Tinta roja bajo consulta  
Rote Tinte auf Anfrage erhältlich  
Inchiostro rosso disponibile su richiesta



\*\*48h not available in Digital finishes 48h non disponibile en impression numérique / \*48h no disponible en acabados digitales/ 48h bei digitalen Ausführungen nicht erhältlich / \*48h non disponibile in finiture digital

Clear Ballpen - 1025



FR > Plus de 10 000 clics !

ES > ¡Más de 10000 clics!

DE > Mehr als 10000 Klicks!

IT > Più di 10.000 clic!





Opaque Ballpen 1025 / Pencil 1028



01 12 10 03 5C 2D 05 3D 04 07 18 02

Colour ink  
 Encre de couleur  
 Color de la tinta  
 Schreibfarbe  
 Colore inchiostro

Red Ink available under request  
 Encre rouge disponible sur demande  
 Tinta roja bajo consulta  
 Rote Tinte auf Anfrage erhältlich  
 Inchiostro rosso disponibile su richiesta

5G



\*\*48h not available in Digital finishes 48h non disponibile en impression numérique / \*48h no disponible en acabados digitales/ 48h bei digitalen Ausführungen nicht erhältlich / \*48h non disponibile in finiture digitale

Frosted Ballpen 1025 / Pencil 1028

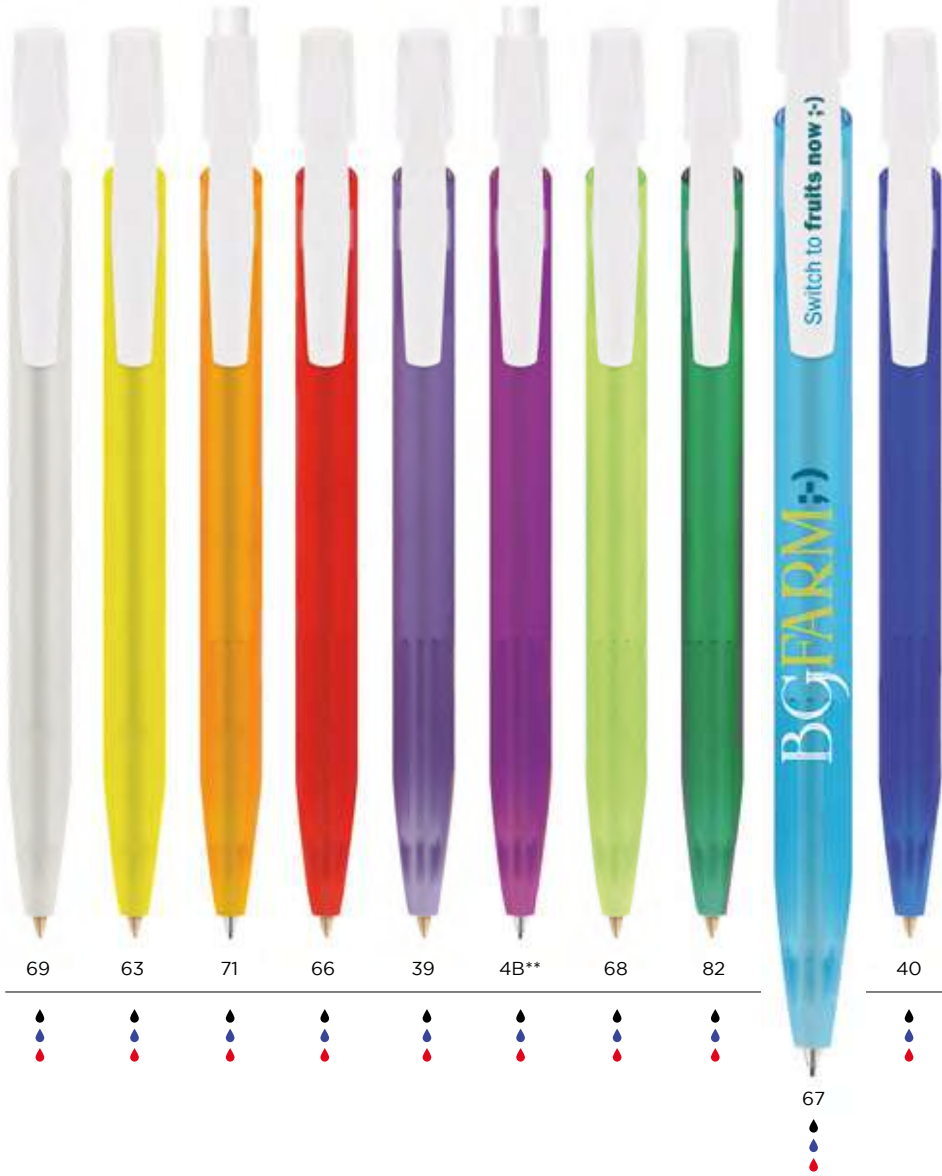

69

63

71

66

39

4B\*\*

68

82

40

67

\*\*while stock lasts  
 \*\*jusqu'à fin du stock  
 \*\*hasta fin de existencias  
 \*\*Gültig solange Vorrat reicht  
 \*\*fino ad esaurimento scorte

\*The percentage is calculated on total weight of product excluding cartridge  
 \*Pourcentage calculé sur le poids total du produit en excluant le cartouche  
 \*Porcentaje calculado a partir del peso total del producto excluyendo el cartucho  
 \*Der Prozentsatz bezieht sich auf das Gesamtgewicht des Produkts ohne Patrone  
 \*La percentuale é calcolata sul peso totale del prodotto refill escluso



MADE FROM 92% OF RECYCLED MATERIAL\* & 100% RECYCLABLE

eColutions®

Opaque Ballpen - 1E25  
 Pencil 1E28



1E

3E

\*The percentage is calculated on total weight of barrel.



Opaque Ballpen 1020  
Pencil 1021

Frosted Ballpen 1020 / Pencil 1021



Colour ink  
Encre de couleur  
Color de la tinta  
Schreibfarbe  
Colore inchiostro

Red Ink available under request  
Encre rouge disponible sur demande  
Tinta roja bajo consulta  
Rote Tinte auf Anfrage erhältlich  
Inchiostro rosso disponibile su richiesta



\*\*48h not available in Digital finishes 48h non disponibile en impression numérique / \*48h no disponible en acabados digitales/ 48h bei digitalen Ausführungen nicht erhältlich / \*48h non disponibile in finiture digitale





MADE FROM 50% OF RECYCLED MATERIAL\* & 100% RECYCLABLE

ecoLutions®

Opaque Ballpen 1E20  
Pencil 1E21



\*The percentage is calculated on total weight of barrel  
 \*Pourcentage calculé sur le poids total du corps du stylo  
 \*Porcentaje calculado a partir del peso total del cuerpo del bolígrafo  
 \*Der Prozentsatz wird vom gesamten Schaftgewicht berechnet  
 \*La percentuale é calcolata sul peso totale del fusto

## Digital Printing!

BIC® MEDIA CLIC DIGITAL

Opaque **New!**  
Ballpen 1025 / 1E25  
Pencil 1028 / 1E28

BIC® MEDIA CLIC GRIP DIGITAL

Opaque  
Ballpen 1020 / 1E20  
Pencil 1021 / 1E21



Only available in white barrel  
 Disponible en corps blanc  
 Solo disponible en cuerpo blanco  
 Mit weißem Schaft erhältlich  
 Disponibile solo in fusto bianco

Only available in white barrel  
 Disponible en corps blanc  
 Solo disponible en cuerpo blanco  
 Mit weißem Schaft erhältlich  
 Disponibile solo in fusto bianco

Check out the video

Regardez la video / Mira el video / Produktvideo / Guarda il video



**MOQ 500u.**

**Standard colours combination**

Combinaison de couleurs standards / Combinación de colores estandard / Standardfarbkombination / **ECOolutions**® Standard colours combination / Combinazione colori standard

**Plug**

Bouton / Botón / Endstück / Pulsante

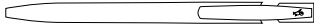

OPAQUE 01 12 10 03 5C 2D 13 84\* 85\* 5G 05 3D 83\* 04 07 18 02 FROSTED 69

**Clip**

Clip / Clip / Clip / Clip



OPAQUE 01 12 10 03 5C 2D 13 84\* 85\* 5G 05 3D 83\* 04 07 18 02 FROSTED 69

**Barrel**

Corps / Cuerpo / Schaft / Fusto



OPAQUE 01 12 10 03 5C 2D 13 85\* 5G 05 3D 83\* 04 07 3C 18 02 01/12 01/03 01/05 01/07 01/02

**Barrel & Grip**

FROSTED 69 63 71 66 39 4B\* 68 82 67 40 01/69 69/69 71/69 66/69 82/69 40/69

POLISHED 1T 8T 6P 3T 6T 9T 5P 5T 4T 7T 8L 2T

CLEAR 1R 4D 92 87 95 93 88 72 4R 7R 91

**Exact colour match:**

Correspondance exacte des couleurs / Color exacto / Exakte Farbübereinstimmung / Esatta corrispondenza di colore

≥ 10.000 units 1025/1028 1E25/1E28 1E20/1E21  
 ≥ 20.000 units 1020/1021 1E20 digital/1E21 digital

**Writing modes:**

Mode écriture / Modos de escritura / Schreibmodi / Modalità di scrittura

Ballpen **M**  
 Mechanical pencil **MP**  
 Ø0,7mm

**Printing techniques:**

Techniques d'impression / Técnicas de impresión / Drucktechniken / Tecniche di stampa

(SP) SCREEN PRINTING  
 (DG) DIGITAL



Add the Möbius loop to your artwork at no additional charge. Please specify "Print the Möbius loop" on your order. (Möbius loop imprint defaults to left-hand hand corner.)



OPAQUE 1E 3E

**Barrel & Grip** OPAQUE

01/12 01/03 01/05 01/07 01/02

FR > Ajoutez la boucle Möbius sur votre BAT sans frais additionnel. Merci de le préciser dans votre bon de commande (en bas à gauche par défaut)

ES > Añade el Möbius loop a tu arte final sin cargo adicional. Por favor asegúrate de especificarlo en tu pedido. (La impresión del Möbius loop a mano izquierda en la esquina).

DE > Auf Wunsch können wir ihre Grafik ohne Zusatzkosten mit einer Möbiusband-Prägung versehen. Bitte geben Sie diesen Wunsch bei der Bestellung an. (Die Möbiusband-Prägung wird standardmäßig in der linken Ecke platziert.)

IT > Aggiungi il Mobius loop alla tua grafica senza costi addizionali. Si prega di specificarlo nell'ordine. La stampa del Mobius loop viene fatta di default per destrorsi nell'angolo destro.

## Decoration:

Personnalisation / Personalización / Dekoration / Decorazione

### BIC® MEDIA CLIC

1025 (ballpen)  
1028 (pencil)  
eColutions® 1E25 (ballpen)  
eColutions® 1E28 (pencil)

**A SP:** max. 4 col.

**B SP:** max. 2 col.

**C DG:** full-colour

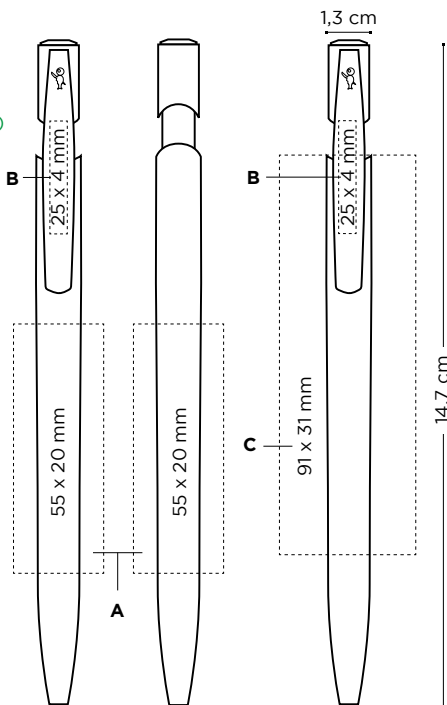

### BIC® MEDIA CLIC GRIP

1020 (ballpen)  
1021 (pencil)  
eColutions® 1E20 (ballpen)  
eColutions® 1E21 (pencil)

**D SP:** max. 4 col.

**E SP:** max. 2 col.

**F DG:** full-colour

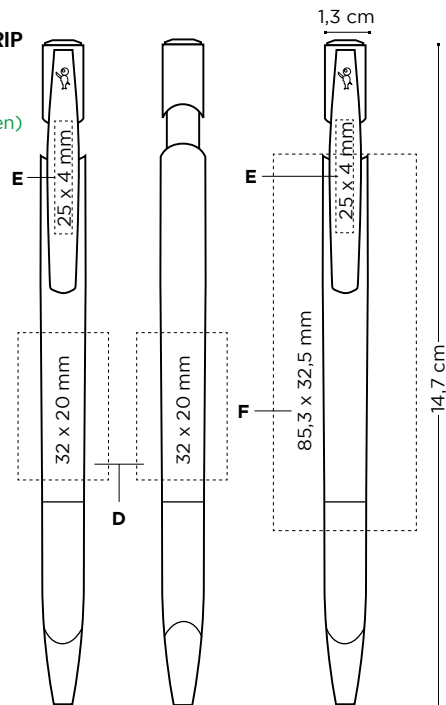

Price (€)

BIC® MEDIA CLIC	500-999	1000-2499	2500-4999	5000-9999	10000-24999	25000-49999
1025 / eColutions® 1E25 (ballpen)						
<b>SP</b>	0,60	0,56	0,52	0,48	0,45	0,42
<b>DG</b>	0,82	0,77	0,71	0,67	①	①
1028 / eColutions® 1E28 (pencil)						
<b>SP</b>	0,78	0,73	0,68	0,64	0,60	0,56

Price (€)

BIC® MEDIA CLIC GRIP	500-999	1000-2499	2500-4999	5000-9999	10000-24999	25000-49999
1020 / eColutions® 1E20 (ballpen)						
<b>SP</b>	0,90	0,84	0,79	0,73	0,68	0,63
<b>DG</b>	1,12	1,05	0,98	0,92	①	①
1021 / eColutions® 1E21 (pencil)						
<b>SP</b>	1,00	0,93	0,87	0,82	0,76	0,71

**Additional imprint charge per colour & position** Frais d'impression supplémentaires par couleur et position / Cargo por impresión adicional por color y posición / Zusätzliche druckkosten pro farbe & position / I prezzi includono la serigrafia ad 1 colore in una posizione.

<b>SP</b>	0,13	0,13	0,13	0,12	0,11	0,11
-----------	------	------	------	------	------	------

**Prices include one imprint in one position according to specified technique.**

Les prix incluent une impression sur un emplacement avec la technique spécifiée / Los precios incluyen una impresión en una posición acorde con la técnica especificada / In den Preisen inbegriffen ist ein Aufdruck auf einer Position gemäß angegebener Technik / I prezzi includono una stampa in una posizione a seconda della tecnica specificata.

① Price under request. Prix sur demande. Precio bajo consulta. Preis auf Anfrage. Prezzi su richiesta

## External packaging:

Emballage externe / Envasado exterior / Außenverpackung / Imballaggio esterno



**500**

BIC® Media Clic ± 4,1 Kg  
BIC® Media Clic Grip ± 4,3 Kg

## New optional special packaging:

Nouvel emballage spécial en option / Nuevo envasado especial opcional / Neue optionale Verpackung / Nuove confezioni speciali opzionali



ECO Sleeve / Plastic Pouch / Window Box  
+ INFO pag. 306

## Check out the video

Regardez la video / Mira el video / Produktvideo / Guarda il video



MADE IN SPAIN





New!

Opaque Ballpen - 1975

MIX & MATCH

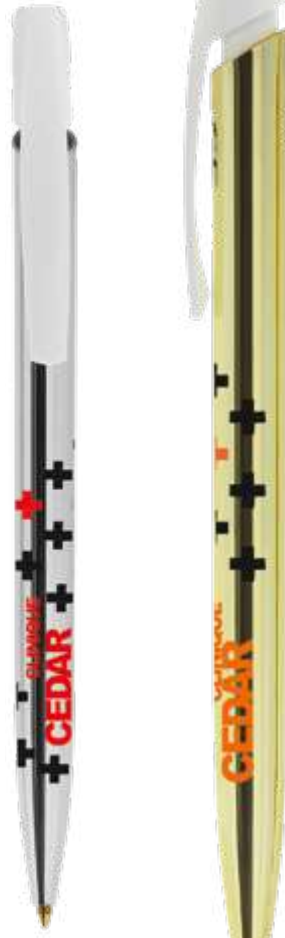

01/75

100%



01/26



Colour ink  
Encre de couleur  
Color de la tinta  
Schreibfarbe  
Colore inchiostro

Red Ink available under request  
Encre rouge disponible sur demande  
Tinta roja bajo consulta  
Rote Tinte auf Anfrage erhältlich  
Inchiostro rosso disponibile su richiesta

MOQ 500u.

Standard colours combination

Combinaison de couleurs standards / Combinación de colores estandar / Standardfarbkombination / Combinazione colori standard

Plug

Bouton / Botón / Endstück / Pulsante



Clip

Clip / Clip / Clip / Clip



Barrel

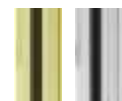

SHINE 01/26 01/75

**BIC® MEDIA CLIC SHINE**

1975

**A SP:** max. 2 col.

**B SP:** max. 2 col.

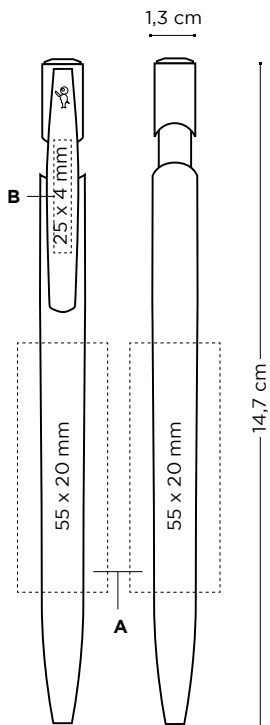

Price (€)

BIC® MEDIA CLIC SHINE	500-999	1000-2499	2500-4999	5000-9999	10000-24999	25000-49999
1975						
<b>SP</b>	1,22	1,14	1,06	0,98	0,92	0,86
<b>SP (premium)</b>	1,36	1,27	1,18	1,09	1,02	0,95

**Additional imprint charge per colour & position.** Frais d'impression supplémentaires par couleur et position / Cargo por impresión adicional por color y posición / Zusätzliche druckkosten pro farbe & position / I prezzi includono la serigrafia ad 1 colore in una posizione.

<b>SP</b>	0,13	0,13	0,13	0,12	0,11	0,11
-----------	------	------	------	------	------	------

**Prices include one imprint in one position according to specified technique.** Les prix incluent une impression sur un emplacement avec la technique spécifiée / Los precios incluyen una impresión en una posición acorde con la técnica especificada / In den Preisen inbegriffen ist ein Aufdruck auf einer Position gemäß angegebener Technik / I prezzi includono una stampa in una posizione a seconda della tecnica specificata.

① Price under request. Prix sur demande. Precio bajo consulta. Preis auf Anfrage. Prezzi su richiesta

**Writing modes:**

Mode écriture / Modos de escritura / Schreibmodi / Modalità di scrittura



**M**  
Ballpen

\*until stock lasts

Jusqu'à épuisement du stock / Hasta que se acabe el stock / Solange der Vorrat reicht / Fino a esaurimento scorte

**Printing techniques:**

Techniques d'impression / Técnicas de impresión / Drucktechniken / Tecniche di stampa



(SP)  
SCREEN  
PRINTING

**New optional special packaging:**

Nouvel emballage spécial en option / Nuevo envasado especial opcional / Neue optionale Verpackung / Nuove confezioni speciali opzionali



ECO Sleeve / Plastic Pouch / Window Box  
+ INFO pag. 306

**External packaging:**

Emballage externe / Envasado exterior / Außenverpackung / Imballaggio esterno



**500 ± 4,1 Kg**



MADE IN  
SPAIN



# THE TOP PRIORITY OF THE MEDIA CLIC BIO ECOLUTIONS® LIFE CYCLE IS SUSTAINABILITY



## BIO-BASED MATERIAL:

The barrel is made from **70% bio-based material**.  
The colourants are **100% bio**.

## BIODEGRADABLE PEN:

No ink left in the pen?  
No problem, it's compostable.  
The barrel is **100% biodegradable** while the clip is **100% recyclable**.

**MADE TO LAST:**

- More than **10,000 clicks**
- Unbreakable clip

## LOW TRANSPORT IMPACT:

Production, printing and even **raw materials made in Europe**

## RENEWABLE ENERGY:

Produced in our factory and printing facilities which are both powered with **100% renewable electricity**.

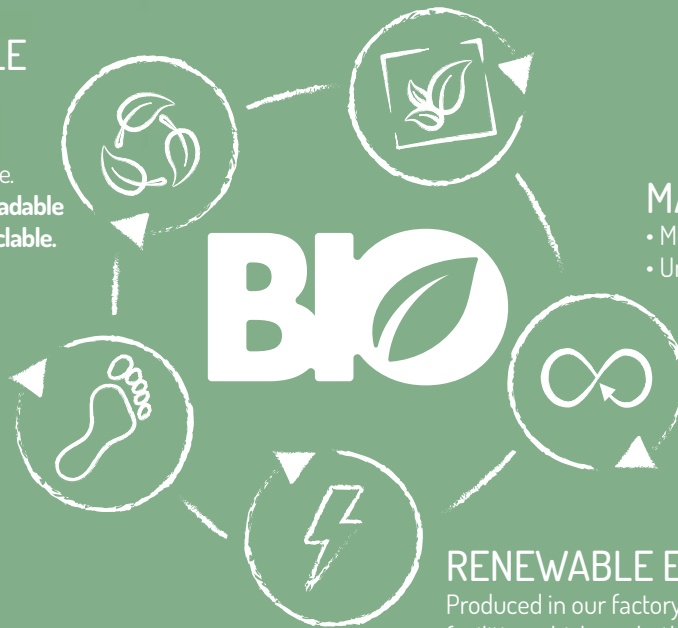

**FR> STYLO BIODÉGRADABLE:** Plus d'encre dans le stylo? Pas de soucis, celui-ci est **décomposable**. Le corps est **100% biodégradable** et le clip est **100% recyclable**.

**MATERIEL BIO** Le corps est fabriqué à partir de **70% de matériel bio**. Les colorants sont **100% bio**.

**FABRIQUÉ POUR DURER:**

- plus de **10.000 clics**
- Clip incassable.

**FAIBLE IMPACT SUR LE TRANSPORT:** Production, marquage et **matières premières fabriqués en Europe**.

**ENERGIE RENOUVELABLE:** Produits dans nos usines et ateliers de marquages tous deux alimentés en **électricité 100% renouvelable**.

**ES> BOLÍGRAFO BIODEGRADABLE:** ¿No queda tinta en el bolígrafo? No hay problema, es **compostable**. El cuerpo es **100% biodegradable**, mientras que el clip es **100% reciclable**.

**MATERIEL BIO:** El cuerpo está hecho el **70% de material bio**. Los colorantes son **100% bio**.

**HECHO PARA DURAR:**

- Más de **10.000 clics**
- Clip irrompible.

**BAJO IMPACTO DE TRANSPORTE:** La producción, impresión e incluso las **materias primas son hechas en Europa**.

**ENERGÍA RENOVABLE:** Producido en nuestra fábrica e instalaciones de impresión, ambas impulsadas con **electricidad 100% renovable**.

**DE> BIOLOGISCH ABBAUBARER KUGELSCHREIBER:** Ist der Kugelschreiber leer? Kein Problem, denn er ist **kompostierbar**! Der Schaft ist zu **100% biologisch abbaubar**, der Clip zu **100% recycelbar**.

**BIOBASIERTES MATERIAL:** Der Schaft besteht zu **70% aus biobasiertem Material**. Die Farbstoffe sind zu **100% natürlich**.

**HOHE LEBENSDAUER:**

- Mehr als **10.000 Klicks**
- Unzerbrechlicher Clip

**GERINGE UMWELTBELASTUNG DURCH KURZE TRANSPORTWEGE:** Die Herstellung, **das Bedrucken und selbst die Rohstoffgewinnung erfolgen in Europa**

**ERNEUERBARE ENERGIEN:** Unsere Produktionsstätten und Druckanlagen werden zu **100% mit erneuerbaren Energien betrieben**.

**IT> PENNA BIODEGRADABILE:** Non rimane inchiostro nella penna? Nessun problema, è **compostabile**. Il fusto è al **100% biodegradabile** mentre la clip è al **100% riciclabile**.

**MATERIALE BASE BIO:** Il fusto è composto al **70% da materiale base bio**. I coloranti sono al **100% bio**.

**FATTA PER DURARE:**

- Oltre **10.000 click**
- Clip indistruttibile.

**BASSO IMPATTO DEL TRASPORTO:** Produzione, stampa e **materie prime sono realizzate in Europa**.

**ENERGIA RINNOVABILE:** L'energia per la produzione e la stampa nelle nostre strutture deriva al **100% da elettricità rinnovabile**.

**BIO** New!

MADE FROM 70% OF BIO-SOURCED\* &  
100% BIODEGRADABLE MATERIAL

**MIX & MATCH**



Opaque Ballpen - 1972



Always visible!

Colour ink  
Encre de couleur  
Color de la tinta  
Schreibfarbe  
Colore inchiostro

Red Ink available under request  
Encre rouge disponible sur demande  
Tinta roja bajo consulta  
Rote Tinte auf Anfrage erhältlich  
Inchiostro rosso disponibile su richiesta

\*The percentage is calculated on total weight of barrel, biodegradable under industrial conditions

\*Le pourcentage est calculé sur le poids total du corps du style.

Biodégradable selon les conditions industrielles exigées

\*Porcentaje calculado a partir del peso total del cuerpo del bolígrafo, biodegradable bajo condiciones industriales.

\*Der Prozentsatz wird vom Gesamtgewicht des unter industriellen Bedingungen biologisch abbaubaren Schafts berechnet

\*La percentuale é calcolata sul peso totale del fusto, biodegradabile in condizioni industriali.

**MOQ 500u.**

**Standard colours combination**

Combinaison de couleurs standards / Combinación de colores estandar / Standardfarbkombination / Combinazione colori standard

**Plug**

Bouton / Botón / Endstück / Pulsante

OPAQUE 01 12 10 03 5C 2D 13 84 85 5G 05 3D 83 04 07 18 02 **FROSTED 69**

**Clip**

Clip / Clip / Clip / Clip

OPAQUE 01 12 10 03 5C 2D 13 84\* 85\* 5G 05 3D 83\* 04 07 18 02 **FROSTED 69**

**Barrel**

Corps / Cuerpo / Schaft / Fusto

OPAQUE 01BIO 012BIO 03BIO 05BIO 04BIO 02BIO

**BIC® MEDIA CLIC BIO**

**eco**olutions®

1972

**A SP:** max. 4 col.

**B SP:** max. 2 col.

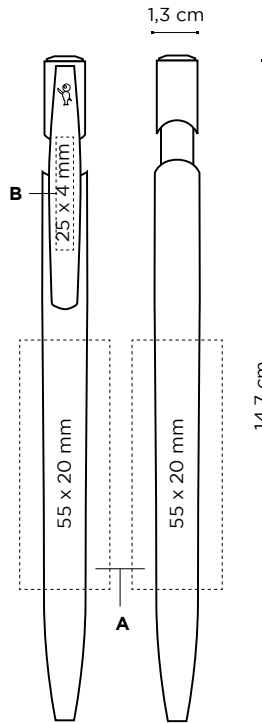

Price (€)

<b>BIC® MEDIA CLIC BIO <b>eco</b>olutions®</b>	500-999	1000-2499	2500-4999	5000-9999	10000-24999	25000-49999
1972						

<b>SP</b>	0,76	0,71	0,66	0,61	0,57	0,53
-----------	------	------	------	------	------	------

**Additional imprint charge per colour & position** Frais d'impression supplémentaires par couleur et position / Cargo por impresión adicional por color y posición / Zusätzliche druckkosten pro farbe & position / I prezzi includono la serigrafia ad 1 colore in una posizione.

<b>SP</b>	0,13	0,13	0,13	0,12	0,11	0,11
-----------	------	------	------	------	------	------

**Prices include 1 colour screenprint in one position.** Les prix incluent la sérigraphie 1 couleur sur un emplacement. En precio incluye un color en serigrafía en una posición. In den Preisen inbegriffen ist 1 Siebdruck-Farbaufdruck auf 1 Position. I prezzi includono la serigrafia ad 1 colore in una posizione.

**Writing modes:**

Mode écriture / Modos de escritura / Schreibmodi / Modalità di scrittura

**Printing techniques:**

Techniques d'impression / Técnicas de impresión / Drucktechniken / Tecniche di stampa

**New optional special packaging:**

Nouvel emballage spécial en option / Nuevo envasado especial opcional / Neue optionale Verpackung / Nuove confezioni speciali opzionali

**External packaging:**

Emballage externe / Envasado exterior / Außenverpackung / Imballaggio esterno

Ballpen



**M**

\*until stock lasts



(SP) SCREEN PRINTING



ECO Sleeve / Plastic Pouch / Window Box + INFO pag. 306



**500 ± 4,3 Kg**



**MADE IN SPAIN**







Modern, flexible, reliable. That's how BIC® Clic Stic is!  
A large variety of finishes such as Digital, Stylus, Softfeel®  
or Mini, and thousands of colour combinations!

FR > Moderne, fiable, flexible.  
C'est la définition même du BIC®  
Clic Stic! Une grande variété de  
finitions telles que Digital, Stylus,  
Softfeel® ou Mini, et plus de mille  
combinaisons de couleurs!

DE > Modern, flexibel, zuverlässig.  
So ist BIC® Clic Stic! In einer  
großen Vielfalt von Oberflächen  
wie Digital, Stylus, Softfeel®  
oder Mini und tausenden von  
Farbkombinationen erhältlich!

ES > Moderno, flexible, fiable. ¡Así  
es BIC® Clic Stic! Amplia variedad  
de acabados, como Digital,  
Stylus, Softfeel® o Mini y miles de  
combinaciones de colores!

IT > Moderna, flessibile, affidabile.  
Ecco com'è BIC® Clic Stic! Una  
grande varietà di rifiniture come  
Digital, Stylus, Softfeel® o Mini,  
e migliaia di combinazioni di  
colore!





MADE FROM 78% OF RECYCLED MATERIAL\* & 100% RECYCLABLE

ecolutions®  
Opaque - 1E00



Opaque - 1000



Iconic BIC® Boy is embossed

Colour ink  
Encre de couleur  
Color de la tinta  
Schreibfarbe  
Colore inchiostro

03

Red Ink available under request  
Encre rouge disponible sur demande  
Tinta roja bajo consulta  
Rote Tinte auf Anfrage erhältlich  
Inchiostro rosso disponibile su richiesta

\*The percentage is calculated on total weight of barrel / \*Pourcentage calculé sur le poids total du corps du stylo / \*Porcentaje calculado a partir del peso total del cuerpo del bolígrafo / \*Der Prozentsatz wird vom gesamten Schaftgewicht berechnet / \*La percentuale é calcolata sul peso totale del fusto.

\*\*48h not available in Digital finishes 48h non disponibile in impression numérique / \*48h no disponibile en acabados digitales/ 48h bei digitalen Ausführungen nicht erhältlich / \*48h non disponibile in finiture digitale



Frosted - 1000

Break resistant clip!



69

63

71

66

68

40

67

FR > Clip résistant incassable !  
 ES > ¡Clip irromplible!  
 DE > Bruchsicherer Clip!  
 IT > Clip indistruttibile!



MADE FROM 78% OF RECYCLED MATERIAL\* & 100% RECYCLABLE

ecolutions®  
 Frosted  
 1E00



2E/8E

2E/10E

2E/3E

2E/7E

\*The percentage is calculated on total weight of barrel

\*The percentage is calculated on total weight of barrel  
 \*Pourcentage calculé sur le poids total du corps du stylo  
 \*Porcentaje calculado a partir del peso total del cuerpo del bolígrafo  
 \*Der Prozentsatz wird vom gesamten Schaftgewicht berechnet  
 \*La percentuale é calcolata sul peso totale del fusto.

BIC® CLIC STIC MINI  
 Opaque - 1892



01





**BIC® CLIC STIC  
SOFTFEEL®  
Opaque - 1005**

**Frosted - 1005**

**BIC® CLIC STIC STYLUS  
Opaque - 1847**



20  
07

40

02

Colour ink  
Encre de couleur  
Color de la tinta  
Schreibfarbe  
Colore inchiostro

Red Ink available under request  
Encre rouge disponible sur demande  
Tinta roja bajo consulta  
Rote Tinte auf Anfrage erhältlich  
Inchiostro rosso disponibile su richiesta



01  
03  
04

18  
02

07



\*\*48h not available in Digital finishes 48h non disponibile en impression numérique / \*48h no disponible en acabados digitales/ 48h bei digitalen Ausführungen nicht erhältlich / \*48h non disponibile in finiture digitale

# Digital Printing!

**BIC® CLIC STIC  
DIGITAL**  
Opaque  
1000 / 1E00



**BIC® CLIC STIC  
MINI DIGITAL**  
Opaque  
1892

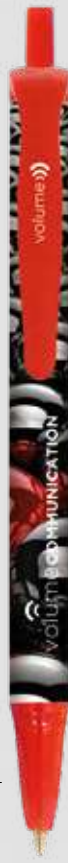

**BIC® CLIC STIC  
STYLUS DIGITAL**  
Opaque  
1847



01  
●  
●  
●

01  
●  
●  
●

01  
●  
●  
●

Only available in white barrel  
Disponibile en corps blanc  
Solo disponible en cuerpo blanco  
Mit weißem Schaft erhältlich  
Disponibile solo in fusto bianco

**MOQ 500u.**

**Standard colours combination**

Combinaison de couleurs standard / Combinación de colores estandar / Standardfarbkombination / Combinazione colori standard

**Plug**

Bouton / Botón / Endstück / Pulsante

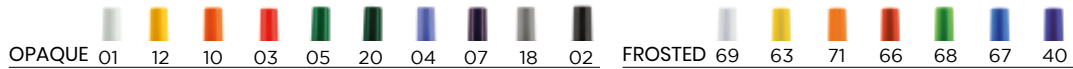

**Clip**

Clip / Clip / Clip / Clip



**Section**

Section / Sección / Teil / Sezione



**stylus**

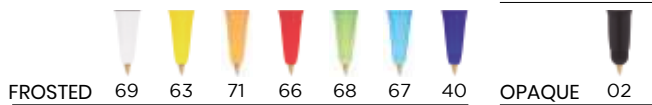

**Barrel**

Corps / Cuerpo / Schaft / Fusto

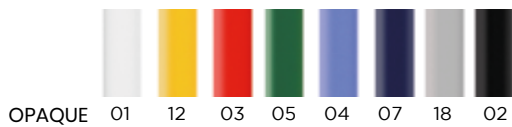

**softfeel®**

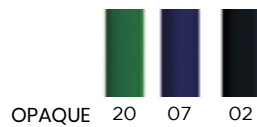

**Mini**

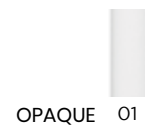

**softfeel®**

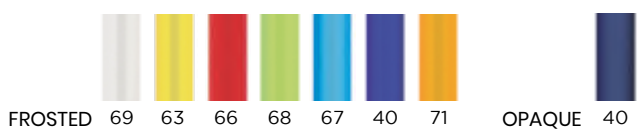

**Exact colour match:**

Correspondance exacte des couleurs / Color exacto / Exakte Farbübereinstimmung / Esatta corrispondenza di colore

≥ 10.000 units

**Writing modes:**

Mode écriture / Modos de escritura / Schreibmodi / Modalità di scrittura

Ballpen



M

**Printing techniques:**

Techniques d'impression / Técnicas de impresión / Drucktechniken / Tecniche di stampa



(SP) SCREEN PRINTING



(DG) DIGITAL

## MOQ 500u.

**eColutions®** Standard colours combination  
 Combinaison de couleurs standards / Combinación de colores estandar / Standardfarbkombination /  
 Combinazione colori standard

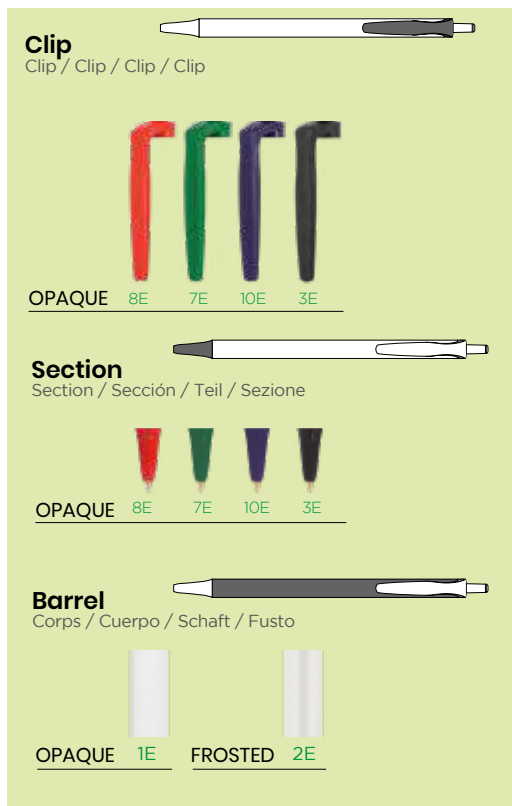
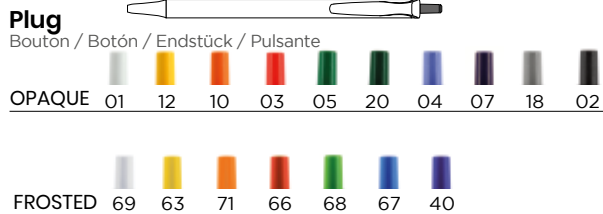

Add the Möbius loop to your artwork at no additional charge. Please specify "Print the Möbius loop" on your order. (Möbius loop imprint defaults to left-hand corner.)

FR > Ajoutez la boucle Möbius sur votre BAT sans frais additionnel. Merci de le préciser dans votre bon de commande (en bas à gauche par défaut).

ES > Añade el Möbius loop a tu arte final sin cargo adicional. Por favor asegúrate de especificarlo en tu pedido. (La impresión del Möbius loop a mano izquierda en la esquina).

DE > Auf Wunsch können wir ihre Grafik ohne Zusatzkosten mit einer Möbiusband-Prägung versehen. Bitte geben Sie diesen Wunsch bei der Bestellung an. (Die Möbiusband-Prägung wird standardmäßig in der linken Ecke platziert.)

IT > Aggiungi il Mobius loop alla tua grafica senza costi addizionali. Si prega di specificarlo nell'ordine. La stampa del Mobius loop viene fatta di default per destrorsi nell'angolo destro.

### Exact colour match:

Correspondance exacte des couleurs /  
 Color exacto / Exakte Farbübereinstimmung /  
 Esatta corrispondenza di colore

≥ 10.000 units

### Writing modes:

Mode écriture / Modos de escritura / Schreibmodi /  
 Modalità di scrittura

Ballpen



M

### Printing techniques:

Techniques d'impression / Técnicas de impresión / Drucktechniken /  
 Tecniche di stampa



(SP)  
 SCREEN  
 PRINTING



(DG)  
 DIGITAL

**Decoration:**

Personnalisation / Personalización / Dekoration / Decorazione

**BIC® CLIC STIC**

1000

ecoSolutions® 1E00

**BIC® CLIC STIC STYLUS**

1847

**A SP:** max. 3 col.

**B SP:** max. 1 col.

**C SP:** max. 2 col.

**D DG:** full-colour (area for text)  
(available in white barrel)

**E DG:** full-colour (area for images)  
(available in white barrel)

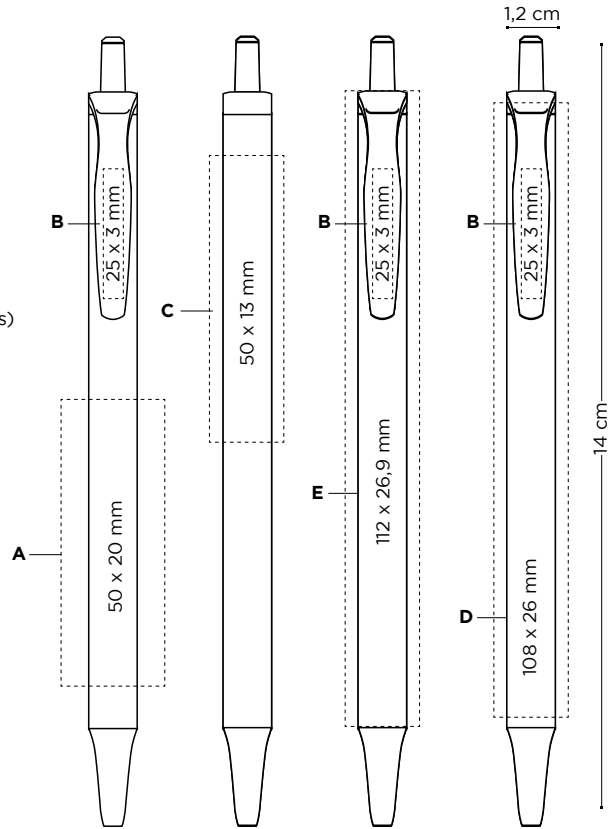

Price (€)

	500-999	1000-2499	2500-4999	5000-9999	10000-24999	25000-49999
<b>BIC® CLIC STIC</b>						
1000 / ecoSolutions® 1E00						
<b>SP</b>	0,75	0,70	0,66	0,62	0,58	0,54
<b>DG</b>	1,00	0,93	0,87	0,82	①	①
<b>1847</b>						
<b>SP</b>	0,90	0,84	0,79	0,73	①	①
<b>DG</b>	1,14	1,06	0,99	0,93	①	①
<b>Additional imprint charge per colour &amp; position</b>						
<b>SP</b>	0,13	0,13	0,13	0,12	0,11	0,11

**Prices include one imprint in one position according to specified technique.** Les prix incluent une impression sur un emplacement avec la technique spécifiée / Los precios incluyen una impresión en una posición acorde con la técnica especificada / In den Preisen inbegriffen ist ein Aufdruck auf einer Position gemäß angegebener Technik / I prezzi includono la serigrafia ad 1 colore in una posizione  
 ① Price under request. Prix sur demande. Precio bajo consulta. Preis auf Anfrage. Prezzi su richiesta.

**New optional special packaging:**

Nouvel emballage spécial en option / Nuevo envasado especial opcional / Neue optionale Verpackung / Nuove confezioni speciali opzionali

**External packaging:**

Emballage externe / Envasado exterior / Außenverpackung / Imballaggio esterno



ECO Sleeve / Plastic Pouch  
+ INFO pag. 306



500 ± 2,9 Kg



MADE IN SPAIN



### BIC® CLIC STIC SOFTFEEL®

1005

A/B SP: max. 1 col.

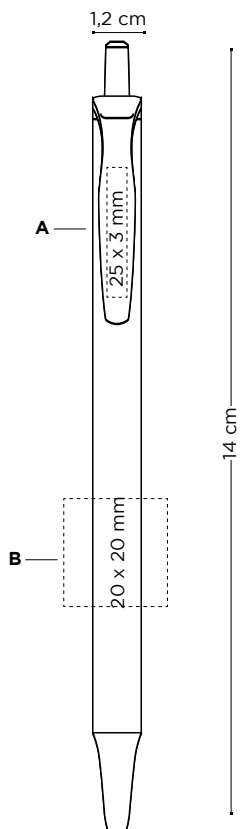

### BIC® CLIC STIC MINI

1892

A SP: max. 1 col.

B SP: max. 1 col.

C DG: full-colour (area for text)  
(available in white barrel)

D DG: full-colour (area for images)  
(available in white barrel)

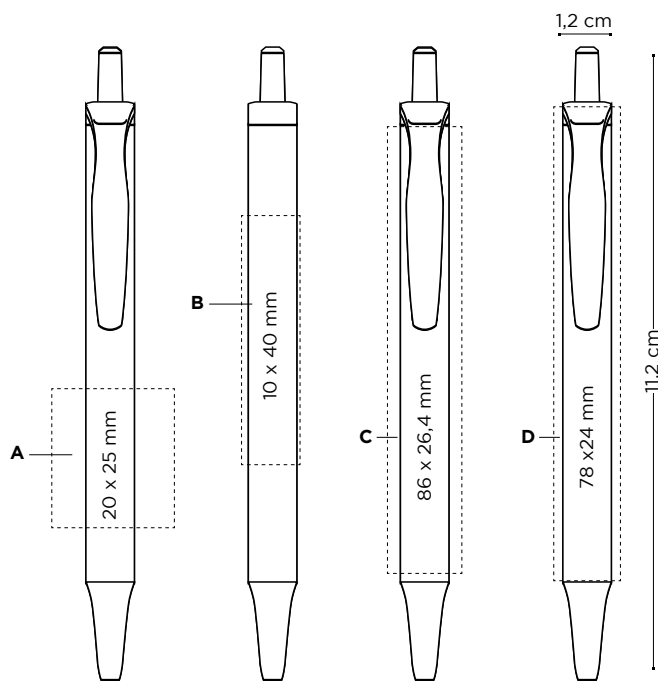

Price (€)

BIC® CLIC STIC SOFTFEEL® 500-999 1000-2499 2500-4999 5000-9999 10000-24999 25000-49999  
1005

SP	0,88	0,82	0,77	0,71	0,66	0,61
----	------	------	------	------	------	------

**Additional imprint charge per colour & position** Frais d'impression supplémentaires par couleur et position / Cargo por impresión adicional por color y posición / Zusätzliche druckkosten pro farbe & position / I prezzi includono la serigrafia ad 1 colore in una posizione.

SP	0,13	0,13	0,13	0,12	0,11	0,11
----	------	------	------	------	------	------

**Prices include 1 colour screenprint in one position.** Les prix incluent la sérigraphie 1 couleur sur un emplacement / En precio incluye un color en serigrafía en una posición / In den Preisen inbegriffen ist 1 Siebdruck-Farbaufdruck auf 1 Position / I prezzi includono la serigrafia ad 1 colore in una posizione

### New optional special packaging:

Nouvel emballage spécial en option / Nuevo envasado especial opcional / Neue optionale Verpackung / Nuove confezioni speciali opzionali



ECO Sleeve / Plastic Pouch

+ INFO pag. 306

### External packaging:

Emballage externe / Envasado exterior / Außenverpackung / Imballaggio esterno



500

BIC® Clic Stic ± 2,9 Kg

BIC® Clic Stic Mini ± 2,4 Kg

Price (€)

BIC® CLIC STIC MINI DIGITAL 500-999 1000-2499 2500-4999 5000-9999 10000-24999 25000-49999  
1892

SP	0,64	0,60	0,56	0,53	①	①
----	------	------	------	------	---	---

DG	0,92	0,86	0,80	0,75	①	①
----	------	------	------	------	---	---

**Prices include one imprint in one position according to specified technique.** Les prix incluent une impression sur un emplacement avec la technique spécifiée / Los precios incluyen una impresión en una posición acorde con la técnica especificada / In den Preisen inbegriffen ist ein Aufdruck auf einer Position gemäß angegebener Technik / I prezzi includono una stampa in una posizione a seconda della tecnica specificata.

① Price under request. Prix sur demande. Precio bajo consulta. Preis auf Anfrage. Prezzi su richiesta





Elegant & versatile design in a wide variety of colours.  
Many customization possibilities in its XXL printing area.

FR > Design élégant et polyvalent, avec une grande variété de couleurs. De nombreuses possibilités de personnalisation avec sa zone d'impression XXL.

ES > Diseño elegante y versátil en gran variedad de colores. Muchas posibilidades de personalización en su XXL area de impresión.

DE > Elegantes, vielseitiges Design in einer Vielzahl Farben. Viele Möglichkeiten der Anpassung an Kundenwünsche auf der XXL Druckfläche.

IT > Design elegante e versatile in un'ampia gamma di colori. Tantissime opzioni di personalizzazione nella sua area di stampa XXL.





Opaque - 1039

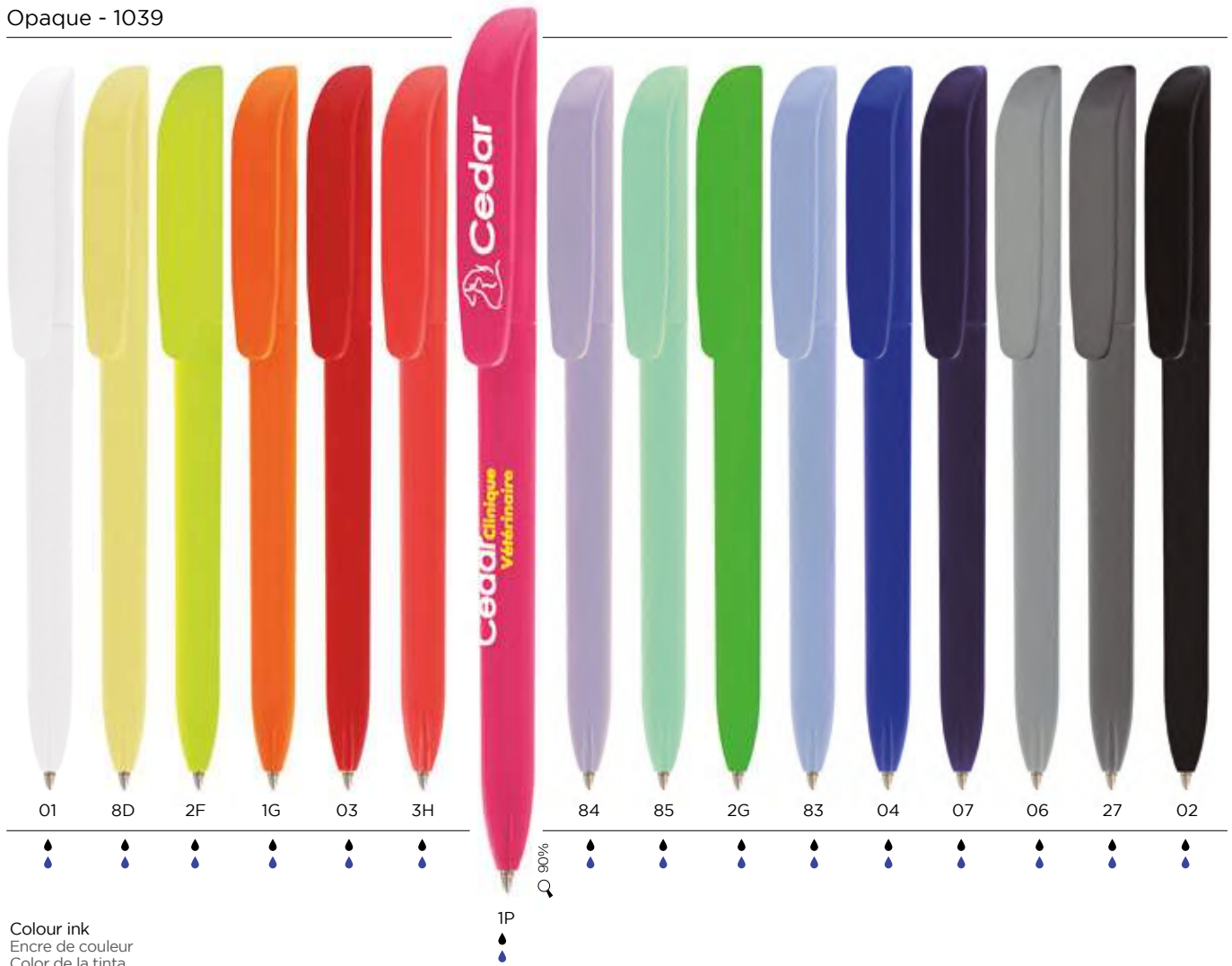

Colour ink  
 Encre de couleur  
 Color de la tinta  
 Schreibfarbe  
 Colore inchiostro



\*\*48h not available in Digital finishes 48h non disponible en impression numérique / \*48h no disponible en acabados digitales/ 48h bei digitalen Ausführungen nicht erhältlich / \*48h non disponibile in finiture digital



MADE FROM 83% OF RECYCLED MATERIAL\* & 100% RECYCLABLE

ecolutions®  
Opaque  
1E50



01/1E

\*The percentage is calculated on total weight of barrel  
/\*Pourcentage calculé sur le poids total du corps du stylo /  
\*Porcentaje calculado a partir del peso total del cuerpo del bolígrafo / \*Der Prozentsatz wird vom gesamten Schaftgewicht berechnet / \*La percentuale é calcolata sul peso totale del fusto.

Clear - 1039



51

92

87

95

93

Cedar  
Cedar  
Cedar  
Veternaire

86

89

88

90%

Digital Printing!

BIC® SUPER CLIP DIGITAL  
Opaque - 1039



01

01

90%

Only available in white barrel  
Disponibile en corps blanc  
Solo disponible en cuerpo blanco  
Mit weißem Schaft erhältlich  
Disponibile solo in fusto bianco

**MOQ 250u.**

**Standard colours combination**

Combinaison de couleurs standards / Combinación de colores estandard / Standardfarbkombination / Combinazione colori standard

**ecolutions®** Standard colours combination

**Clip**

Clip / Clip / Clip / Clip

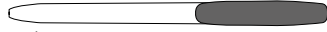

OPAQUE 01 8D 2F 1G 03 3H 1P 84 85 2G 83 04 07 06 27 02



CLEAR 51 92 87 95 93 88 86 89

**Barrel**

Corps / Cuerpo / Schaft / Fusto



OPAQUE 01 8D 2F 1G 03 3H 1P 84 85 2G 83 04 07 06 27 02



CLEAR 51 92 87 95 93 88 86 89



Add the Möbius loop to your artwork at no additional charge. Please specify it on your order. (Möbius loop imprint defaults to left-hand hand corner.)

FR > Ajoutez la boucle Möbius sur votre BAT sans frais additionnel. Merci de le préciser dans votre bon de commande (en bas à gauche par défaut).

DE > Auf Wunsch können wir ihre Grafik ohne Zusatzkosten mit einer Möbiusband-Prägung versehen. Bitte geben Sie diesen Wunsch bei der Bestellung an. (Die Möbiusband-Prägung wird standardmäßig in der linken Ecke platziert.)

ES > Añade el Möbius loop a tu arte final sin cargo adicional. Por favor asegúrate de especificarlo en tu pedido. (La impresión del Möbius loop a mano izquierda en la esquina).

IT > Aggiungi il Mobius loop alla tua grafica senza costi addizionali. Si prega di specificarlo nell'ordine. La stampa del Mobius loop viene fatta di default per destrorsi nell'angolo destro.

**Exact colour match:**

Correspondance exacte des couleurs / Color exacto / Exakte Farbübereinstimmung / Esatta corrispondenza di colore

≥ 10.000 units

**Writing modes:**

Mode écriture / Modos de escritura / Schreibmodi / Modalità di scrittura

**Printing techniques:**

Techniques d'impression / Técnicas de impresión / Drucktechniken / Tecniche di stampa

**New optional special packaging:**

Nouvel emballage spécial en option / Nuevo envasado especial opcional / Neue optionale Verpackung / Nuove confezioni speciali opzionali

**External packaging:**

Emballage externe / Envasado exterior / Außenverpackung / Imballaggio esterno

Ballpen



M



(SP) SCREEN PRINTING



(DG) DIGITAL



(BP) britePix™



ECO Sleeve / Plastic Pouch / Window Box

+ INFO pag. 306



250 ± 2,6 Kg



MADE IN SPAIN

## Decoration:

Personnalisation / Personalización / Dekoration / Decorazione

### BIC® SUPER CLIP

1039

©©olutions® 1E50

**A SP:** max. 2 col.

**B SP:** max. 1 col.

**C DG:** full-colour

**D BP:** full-colour

**BP Texture:** full-colour

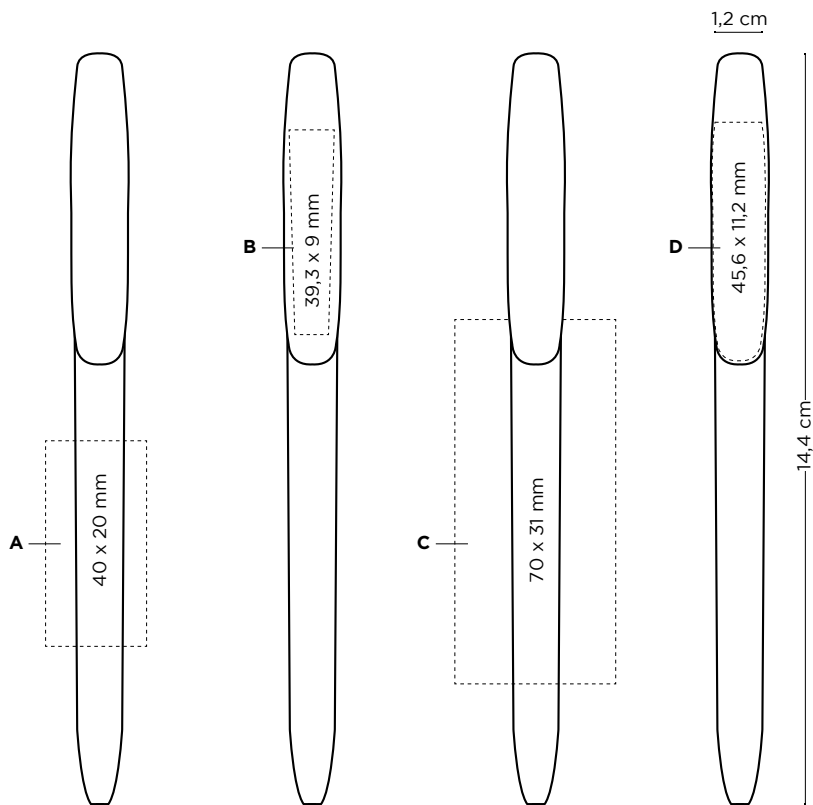

Price (€)

BIC® SUPER CLIP	250-499	500-999	1000-2499	2500-4999	5000-9999	10000-24999	25000-49999
1039 / ©©olutions® 1E50							
<b>SP</b>	1,03	0,98	0,94	0,91	0,88	0,85	0,82
<b>DG</b>	1,33	1,28	1,23	1,19	1,15	①	①
<b>BP</b>	1,29	1,23	1,18	1,13	1,09	1,05	1,00

**Additional imprint charge per colour & position** Frais d'impression supplémentaires par couleur et position / Cargo por impresión adicional por color y posición / Zusätzliche druckkosten pro farbe & position / I prezzi includono la serigrafia ad 1 colore in una posizione.

<b>SP</b>	0,16	0,13	0,13	0,13	0,12	0,11	0,11
<b>BP</b>	0,23	0,21	0,2	0,19	0,18	①	①
<b>*BP Texture</b>	0,17	0,15	0,14	0,14	0,13	0,12	0,12

**Prices include one imprint in one position according to specified technique.** Les prix incluent une impression sur un emplacement avec la technique spécifiée / Los precios incluyen una impresión en una posición acorde con la técnica especificada / In den Preisen inbegriffen ist ein Aufdruck auf einer Position gemäß angegebener Technik / I prezzi includono una stampa in una posizione a seconda della tecnica specificata.

① Price under request. Prix sur demande. Precio bajo consulta. Preis auf Anfrage. Prezzi su richiesta



Opaque - 1073



Colour ink  
Encre de couleur  
Color de la tinta  
Schreibfarbe  
Colore inchiostro

Metal section!

FR > Section en métal !    ES > ¡Sección metálica!    DE > Metallteil!    IT > Sezione in metallo!



\*\*48h not available in Digital finishes 48h non disponibile en impression numérique / \*48h no disponible en acabados digitales/ 48h bei digitalen Ausführungen nicht erhältlich / \*48h non disponibile in finiture digitale





FR > Mécanisme pivotant silencieux !  
 ES > ¡Silencioso mecanismo giratorio!  
 DE > Leiser Drehmechanismus!!  
 IT > Meccanismo arotazione silenzioso

## Digital Printing!

**BIC® SUPER CLIP ADVANCE DIGITAL**  
 Opaque - 1073

01 01

360°

100%

Only available in white barrel  
 Disponible en corps blanc  
 Solo disponible en cuerpo blanco  
 Mit weißem Schaft erhältlich  
 Disponibile solo in fusto bianco





**MOQ 250u.**

**Standard colours combination**

Combinaison de couleurs standards / Combinación de colores estandar / Standardfarbkombination / Combinazione colori standard

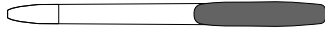

OPAQUE 01 2F 1G 03 3H 1P 2G 04 07 06 27 02



CLEAR 51 92 87 95 93 88 86 89

**Barrel**

Corps / Cuerpo / Schaft / Fusto



OPAQUE 01 2F 1G 03 3H 1P 2G 04 07 06 27 02

**Section**

Section / Sección / Teil / Sezione

**ADVANCE**



35

**Exact colour match:**

Correspondance exacte des couleurs / Color exacto / Exakte Farbübereinstimmung / Esatta corrispondenza di colore

**≥ 10.000 units**

**Writing modes:**

Mode écriture / Modos de escritura / Schreibmodi / Modalità di scrittura

**Printing techniques:**

Techniques d'impression / Técnicas de impresión / Drucktechniken / Tecniche di stampa

**New optional special packaging:**

Nouvel emballage spécial en option / Nuevo envasado especial opcional / Neue optionale Verpackung / Nuove confezioni speciali opzionali

**External packaging:**

Emballage externe / Envasado exterior / Außenverpackung / Imballaggio esterno

**Check out the video**

Regardez la video / Mira el video / Produktvideo / Guarda il video

Ballpen



M



(SP) SCREEN PRINTING



(DG) DIGITAL



(BP) britePix™



ECO Sleeve / Plastic Pouch / Window Box

+ INFO pag. 306



500 ± 3,9 Kg



MADE IN SPAIN



## Decoration:

Personalisation / Personalización / Dekoration / Decorazione

### BIC® SUPER CLIP ADVANCE

1073

**A SP:** max. 2 col.

**B SP:** max. 1 col.

**C DG:** full-colour

**D BP:** full-colour

**BP Texture:** full-colour

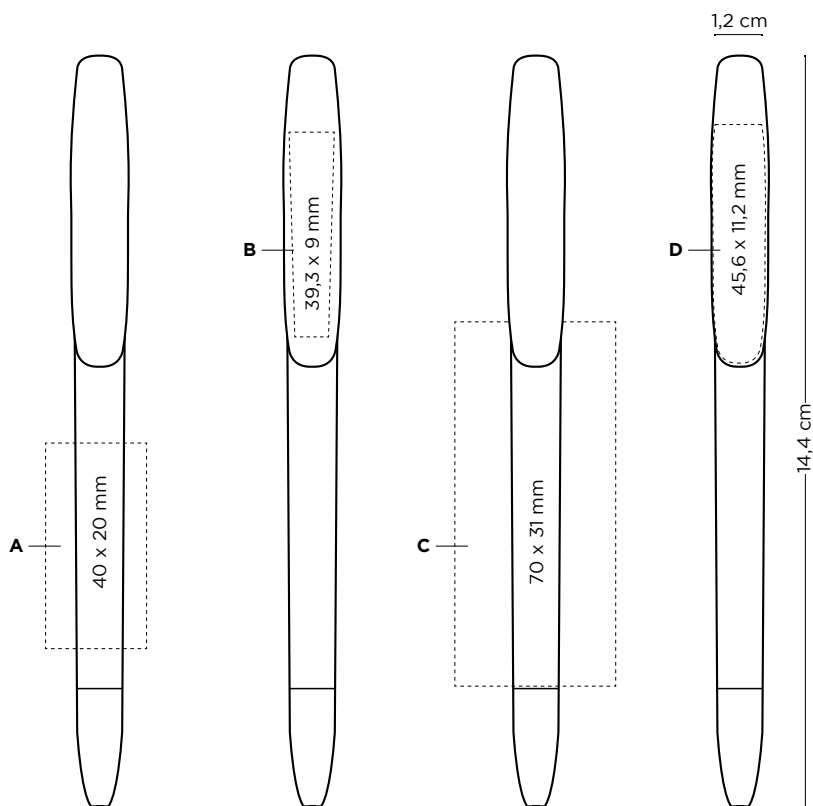

Price (€)

BIC® SUPER CLIP ADVANCE	250-499	500-999	1000-2499	2500-4999	5000-9999	10000-24999	25000-49999
1073							
<b>SP</b>	1,44	1,37	1,31	1,27	1,23	1,19	1,14
<b>DG</b>	1,75	1,66	1,59	1,54	1,49	①	①
<b>BP</b>	1,66	1,57	1,50	1,45	1,40	1,35	1,29

**Additional imprint charge per colour & position** Frais d'impression supplémentaires par couleur et position / Cargo por impresión adicional por color y posición / Zusätzliche druckkosten pro farbe & position / I prezzi includono la serigrafia ad 1 colore in una posizione.

<b>SP</b>	0,16	0,13	0,13	0,13	0,12	0,11	0,11
<b>BP</b>	0,23	0,21	0,2	0,19	0,18	①	①
<b>*BP Texture</b>	0,17	0,15	0,14	0,14	0,13	0,12	0,12

**Prices include one imprint in one position according to specified technique.** Les prix incluent une impression sur un emplacement avec la technique spécifiée / Los precios incluyen una impresión en una posición acorde con la técnica especificada / In den Preisen inbegriffen ist ein Aufdruck auf einer Position gemäß angegebener Technik / I prezzi includono una stampa in una posizione a seconda della tecnica specificata.

① Price under request. Prix sur demande. Precio bajo consulta. Preis auf Anfrage. Prezzi su richiesta.



The right size for showing the true value of your brand! Wide profile and wide variety of possibilities to maximise your message.

FR > La taille idéale pour montrer la vraie valeur de votre marque ! Profil large et multiples possibilités pour optimiser votre communication.

DE > Die richtige Größe, um den wahren Wert Ihrer Marke zu zeigen! Breites Profil und eine Vielzahl von Möglichkeiten, Ihre Botschaft maximal zu vermitteln.

ES > ¡El tamaño correcto para enseñar el valor real de tu marca! De perfil ancho y gran variedad de posibilidades para maximizar tu mensaje

IT > La giusta misura per mostrare il vero valore del tuo marchio! Ampio profilo e vasta gamma di possibilità per ottimizzare il tuo messaggio.







**MIX & MATCH**



Iconic BIC® Boy is embossed

Opaque - 1080



Colour ink  
Encre de couleur  
Color de la tinta  
Schreibfarbe  
Colore inchiostro

Red Ink available under request  
Encre rouge disponible sur demande  
Tinta roja bajo consulta  
Rote Tinte auf Anfrage erhältlich  
Inchiostro rosso disponibile su richiesta



MADE FROM 94% OF RECYCLED MATERIAL\* & 100% RECYCLABLE

**ecolutions®**  
Opaque - 1E80



\*The percentage is calculated on total weight of barrel  
/\*Pourcentage calculé sur le poids total du corps du stylo / \*Porcentaje calculado a partir del peso total del cuerpo del bolígrafo / \*Der Prozentsatz wird vom gesamten Schaftgewicht berechnet / \*La percentuale è calcolata sul peso totale del fusto.

\*\*48h not available in Digital finishes 48h non disponibile en impression numérique / \*48h no disponible en acabados digitales/ 48h bei digitalen Ausführungen nicht erhältlich / \*48h non disponibile in finiture digital



Frosted - 1080



FR > Notre plus grande zone d'impression !  
ES > Nuestra área de impresión más grande  
DE > Unsere größte Druckfläche  
IT > La nostra area di stampa più grande



**BIC® WIDE BODY™ CHROME**  
Opaque - 1079

Frosted - 1079

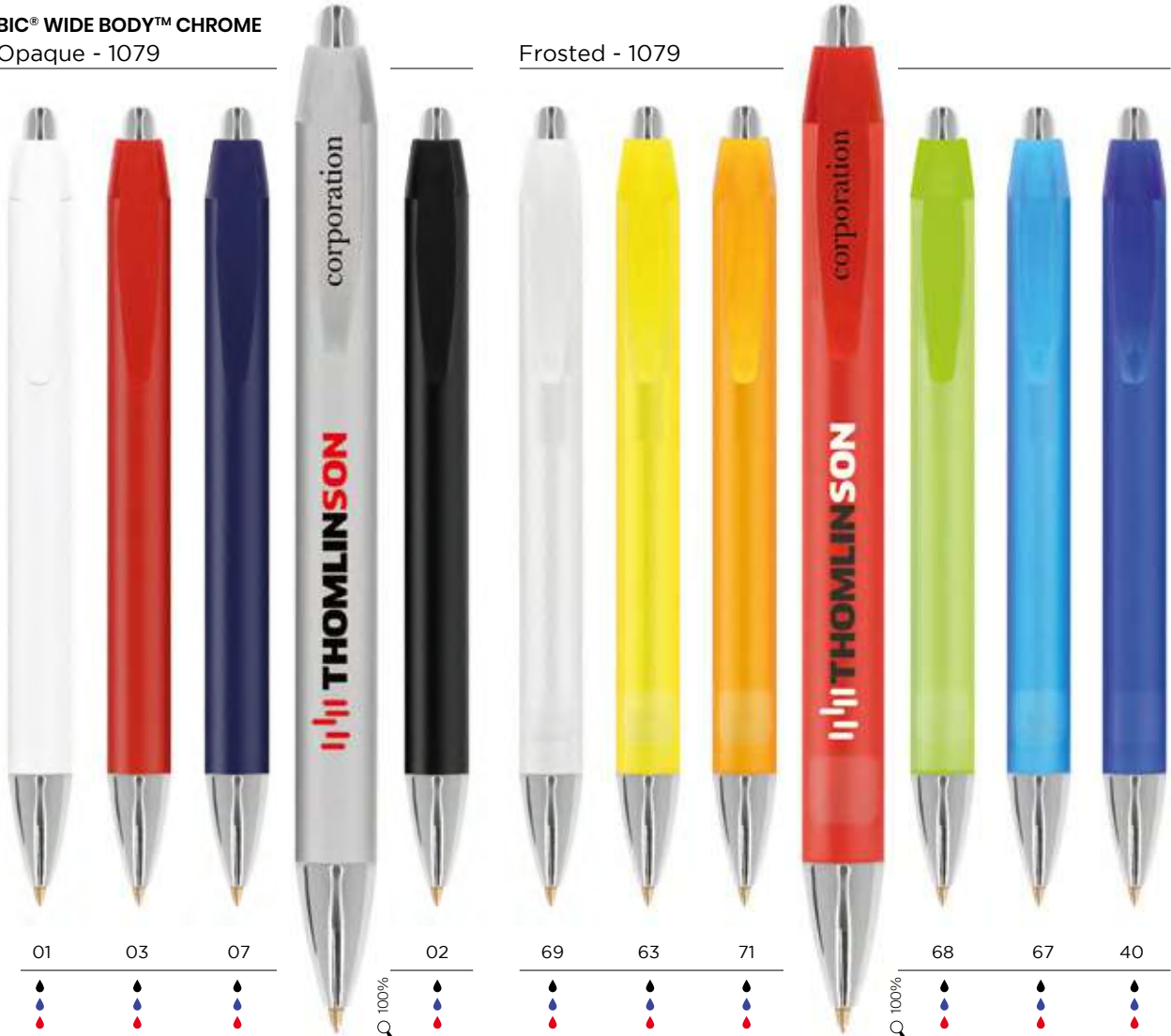

01

03

07

18

02

69

63

71

66

68

67

40

Colour ink  
Encre de couleur  
Color de la tinta  
Schreibfarbe  
Colore inchiostro

Red Ink available under request  
Encre rouge disponible sur demande  
Tinta roja bajo consulta  
Rote Tinte auf Anfrage erhältlich  
Inchiostro rosso disponibile su richiesta



\*\*48h not available in Digital finishes 48h non disponibile en impression numérique / \*48h no disponible en acabados digitales/ 48h bei digitalen Ausführungen nicht erhältlich / \*48h non disponibile in finiture digital



## Digital Printing!

**BIC® WIDE BODY™  
DIGITAL**  
Opaque  
1080 / 1E80

**BIC® WIDE BODY™  
MINI DIGITAL**  
Opaque - 1893



03 Only available in white barrel 01  
 Disponible en corps blanc  
 Solo disponible en cuerpo blanco  
 Mit weißem Schaft erhältlich  
 Disponibile solo in fusto bianco

## Digital Printing!

**BIC® WIDE BODY™  
CHROME DIGITAL**  
Opaque - 1079

**BIC® WIDE BODY™  
CHROME MINI DIGITAL**  
Opaque - 1896



01  
 01



**MOQ 250u.**

**Standard colours combination**

Combinaison de couleurs standards / Combinación de colores estandard / Standardfarbkombination / Combinazione colori standard

**Plug**

Bouton / Botón / Endstück / Pulsante

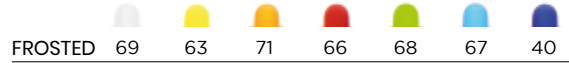

**Chrome**



**Clip**

Clip / Clip / Clip / Clip

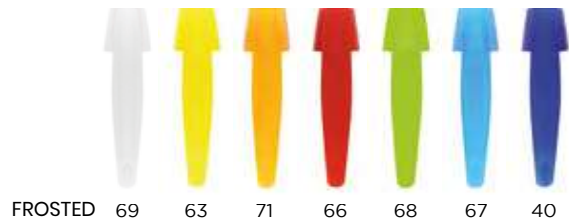
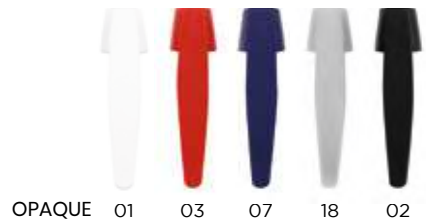

**Barrel**

Corps / Cuerpo / Schaft / Fusto

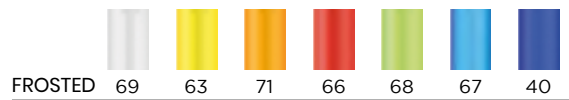
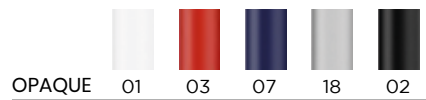

**Section**

Section / Sección / Teil / Sezione

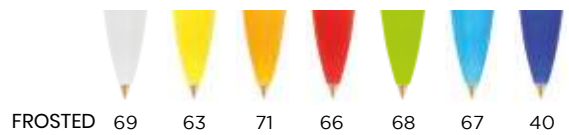
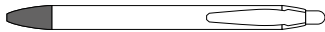

**Exact colour match:**

Correspondance exacte des couleurs / Color exacto / Exakte Farbübereinstimmung / Esatta corrispondenza di colore

≥ 10.000 units

**Writing modes:**

Mode écriture / Modos de escritura / Schreibmodi / Modalità di scrittura

**Printing techniques:**

Techniques d'impression / Técnicas de impresión / Drucktechniken / Tecniche di stampa

Ballpen



M



(SP) SCREEN PRINTING



(DG) DIGITAL

## MOQ 250u.



### Standard colours combination

Combinaison de couleurs standards / Combinación de colores estandar / Standardfarbkombination /  
Combinazione colori standard

#### Plug



#### Clip

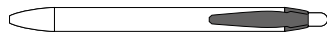

#### Barrel

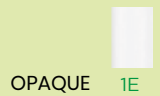
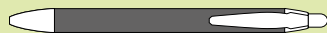

Add the Möbius loop to your artwork at no additional charge. Please specify "Print the Möbius loop" on your order. (Möbius loop imprint defaults to left-hand hand corner.)

#### Section



#### Exact colour match:

Correspondance exacte des couleurs / Color exacto /  
Exakte Farbübereinstimmung / Esatta corrispondenza  
di colore

≥ 10.000 units

#### Writing modes:

Mode écriture /  
Modos de escritura /  
Schreibmodi /  
Modalità di scrittura

#### Printing techniques:

Techniques d'impression /  
Técnicas de impresión /  
Drucktechniken /  
Tecniche di stampa

#### Ballpen



M



(SP)  
SCREEN  
PRINTING



(DG)  
DIGITAL

FR > Ajoutez la boucle Möbius sur  
votre BAT sans frais additionnel.  
Merci de le préciser dans votre bon  
de commande (en bas à gauche  
par défaut).

DE > Auf Wunsch können wir ihre  
Grafik ohne Zusatzkosten mit einer  
Möbiusband-Prägung versehen.  
Bitte geben Sie diesen Wunsch bei  
der Bestellung an. (Die Möbiusband-  
Prägung wird standardmäßig in der  
linken Ecke platziert.)

ES > Añade el Möbius loop a tu  
arte final sin cargo adicional. Por  
favor asegúrate de especificarlo  
en tu pedido. (La impresión del  
Möbius loop a mano izquierda en  
la esquina).

IT > Aggiungi il Mobius loop alla  
tua grafica senza costi addizionali.  
Si prega di specificarlo nell'ordine.  
La stampa del Mobius loop viene  
fatta di default per destrorsi  
nell'angolo destro.

**Decoration:**

Personnalisation / Personalización / Dekoration / Decorazione

**BIC® WIDE BODY™**

1080

©©olutions® 1E80

**BIC® WIDE BODY™ CHROME**

1079

**A/C SP:** max. 2 col.

**B/F SP:** max. 1 col.

**D DG:** full-colour (area for images)

**E DG:** full-colour (area for text)

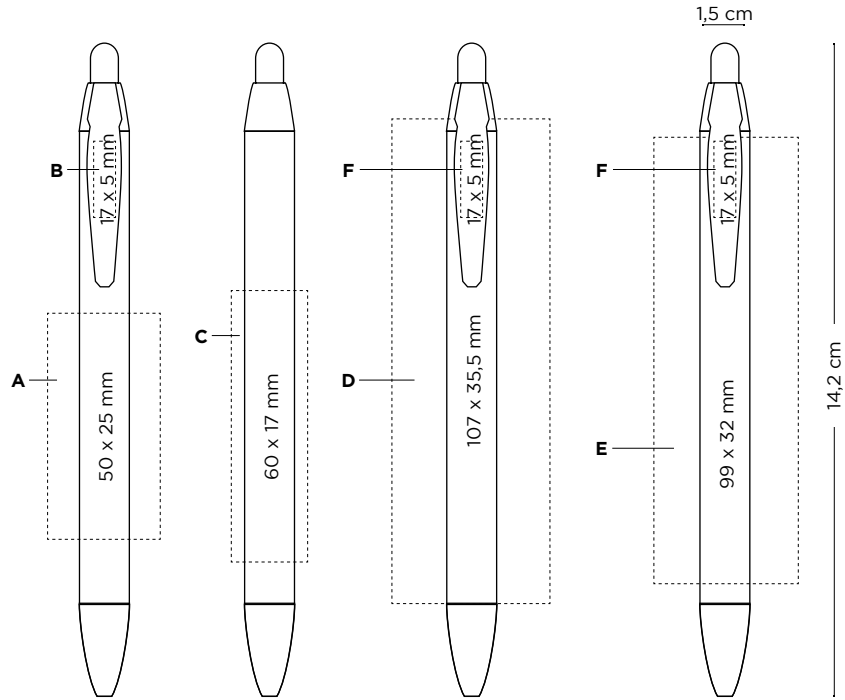

Price (€)

BIC® WIDE BODY™	250-499	500-999	1000-2499	2500-4999	5000-9999	10000-24999	25000-49999
1080 / ©©olutions® 1E80							
<b>SP</b>	1,06	0,97	0,91	0,85	0,78	①	①
<b>DG</b>	-	1,35	1,25	1,17	1,10	①	①
1079							
<b>SP</b>	2,02	1,84	1,71	1,62	1,48	①	①
<b>DG</b>	-	2,21	2,06	1,95	1,81	①	①

**Additional imprint charge per colour & position** Frais d'impression supplémentaires par couleur et position / Cargo por impresión adicional por color y posición / Zusätzliche druckkosten pro farbe & position / I prezzi includono la serigrafia ad 1 colore in una posizione.

<b>SP</b>	0,16	0,13	0,13	0,13	0,12	①	①
-----------	------	------	------	------	------	---	---

**Prices include one imprint in one position according to specified technique.** Les prix incluent une impression sur un emplacement avec la technique spécifiée / Los precios incluyen una impresión en una posición acorde con la técnica especificada / In den Preisen inbegriffen ist ein Aufdruck auf einer Position gemäß angegebener Technik / I prezzi includono una stampa in una posizione a seconda della tecnica specificata.

① Price under request. Prix sur demande. Precio bajo consulta. Preis auf Anfrage. Prezzi su richiesta.

**New optional special packaging:**

Nouvel emballage spécial en option / Nuevo envasado especial opcional / Neue optionale Verpackung / Nuove confezioni speciali opzionali

**External packaging:**

Emballage externe / Envasado exterior / Außenverpackung / Imballaggio esterno



ECO Sleeve / Plastic Pouch / Window Box



250 ± 2,6 Kg



MADE IN SPAIN

**BIC® WIDE BODY™ MINI DIGITAL**

1893

**BIC® WIDE BODY™ MINI CHROME DIGITAL**

1896

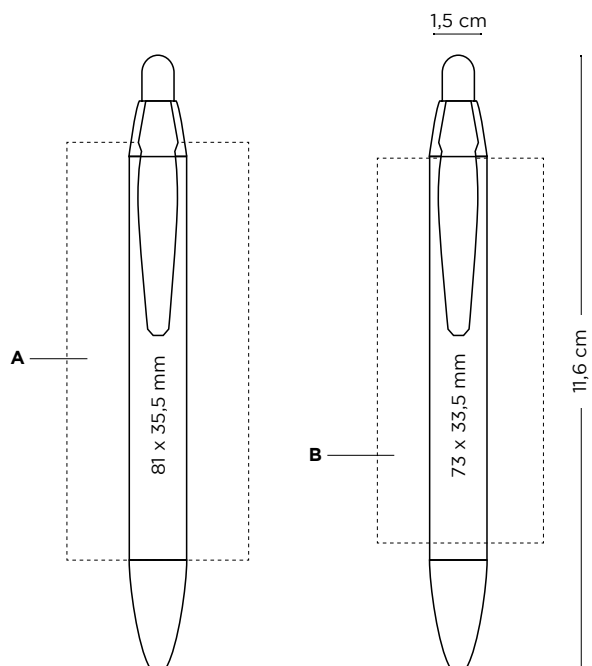
**A DG:** full-colour (area for images)**B DG:** full-colour (area for text)

	Price (€)					
<b>BIC® WIDE BODY™ MINI DIGITAL</b>	500-999	1000-2499	2500-4999	5000-9999	10000-24999	25000-49999
1893						
<b>DG</b>	1,19	1,11	1,04	0,98	①	①
1896						
<b>DG</b>	2,06	1,92	1,82	1,68	①	①

**Prices include digital imprint on barrel.** Les prix incluent l'impression numérique sur le corps. El precio incluye impresión digital en el cuerpo. Preise beinhalten Digitaldruck auf dem Schaft. I prezzi comprendono la stampa digitale sul fusto.

① Price under request. Prix sur demande. Precio bajo consulta. Preis auf Anfrage. Prezzi su richiesta.

**New optional special packaging:**

Nouvel emballage spécial en option / Nuevo envasado especial opcional / Neue optionale Verpackung / Nuove confezioni speciali opzionali



Plastic Pouch

**External packaging:**

Emballage externe / Envasado exterior / Außenverpackung / Imballaggio esterno

**250** ± 1,9 Kg**MADE IN SPAIN**



Opaque - 1053

Clear - 1053



Iconic BIC® Boy is embossed



Colour ink  
Encre de couleur  
Color de la tinta  
Schreibfarbe  
Colore inchiostro



01/02 100%



51/07



51/02 100%

soft grip, easy to handle

FR > Grip doux, bonne prise en main ES > Grip suave, fácil manejo  
IT > Morbida impugnatura, molto maneggevole

DE > Weicher Griff, einfach in der Handhabung

## MOQ 250u.

### Standard colours combination

Combinaison de couleurs standards / Combinación de colores estandar / Standardfarbkombination / Combinazione colori standard

### Decoration:

Personnalisation / Personalización / Dekoration / Decorazione

#### BIC® ATLANTIS®

1053

**A PD:** max. 1 col.

**B/C SP:** max. 2 col.

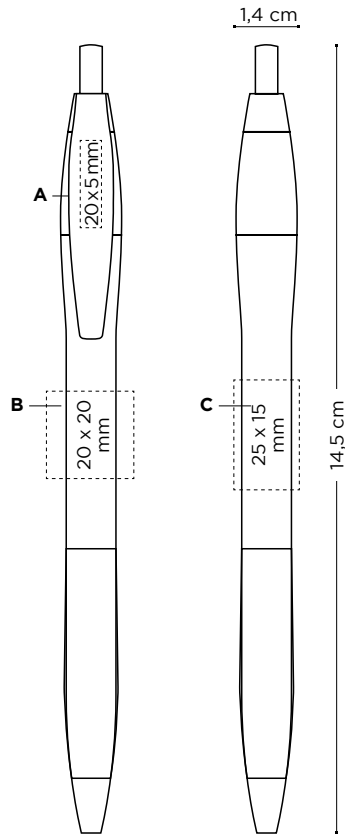

	Price (€)						
<b>BIC® ATLANTIS®</b>	250-499	500-999	1000-2499	2500-4999	5000-9999	10000-24999	25000-49999
1053							
<b>SP/PD</b>	1,38	1,25	1,16	1,08	1,02	①	①

**Additional imprint charge per colour & position** Frais d'impression supplémentaires par couleur et position / Cargo por impresión adicional por color y posición / Zusätzliche druckkosten pro farbe & position / I prezzi includono la serigrafia ad 1 colore in una posizione.

<b>SP/PD</b>	0,16	0,13	0,13	0,13	0,12	①	①
--------------	------	------	------	------	------	---	---

**Prices include 1 colour screenprint in one position.** Les prix incluent la sérigraphie 1 couleur sur un emplacement. En precio incluye un color en serigrafía en una posición. In den Preisen inbegriffen ist 1 Siebdruck-Farbaufdruck auf 1 Position. I prezzi includono 1 colore a serigrafia in una posizione.

① Price under request. Prix sur demande. Precio bajo consulta. Preis auf Anfrage. Prezzi su richiesta.

### Writing modes:

Mode écriture /  
Modos de escritura /  
Schreibmodi /  
Modalità di scrittura

Ballpen



**M**

### Printing techniques:

Techniques d'impression /  
Técnicas de impresión /  
Drucktechniken /  
Tecniche di stampa



(SP)  
SCREEN  
PRINTING



(PD) PAD  
PRINTING

### New optional special packaging:

Nouvel emballage spécial en option / Nuevo  
envasado especial opcional / Neue optionale  
Verpackung / Nuove confezioni speciali opzionali



ECO Sleeve / Plastic Pouch / Window Box

+ INFO pag. 306

### External packaging:

Emballage externe / Envasado  
exterior / Außenverpackung /  
Imballaggio esterno



**250** ± 2,3 Kg

**Easy  
Glide  
SYSTEM**



 **4 COLOURS**

Simple, inventive, reliable. Four different ink colours in one: blue, black, red, green. An icon that's always in fashion!

FR > Simple, fiable, ingénieux. Quatre couleurs d'encre différentes sur un seul stylobille: bleu, noir, rouge, vert. Un stylo emblématique toujours à la mode !

ES > Simple, ingenioso, fiable. Cuatro colores de tinta diferentes en un sólo bolígrafo: azul, negro, rojo, verde. ¡Un icono que siempre está de moda!

DE > Einfach, einfallsreich, zuverlässig. Vier verschiedene Tintenfarben in einem Kugelschreiber: Blau, Schwarz, Rot und Grün! Eine Schreibikone, die immer in Mode bleibt

IT > Semplice, ingegnosa, affidabile. Quattro diversi colori in una sola penna: blu, nero, rosso e verde. Un'icona intramontabile!





# 50

ans/years





# New solution for full colour communication

**BIC Graphic Europe** the pioneer in digital printing

FR> Nouvelle technique pour une communication en numérique BGE Le pionnier du marquage en digital.

DE> Neue Lösung für vollfarbige Kommunikation. BIC Graphic Europe: Der Pionier & Experte für Digitaldruck

ES> Nueva solución para la comunicación a todo color. BIC Graphic Europe pioneros en la impresión digital.

IT - La nuova soluzione per la comunicazione in full colour. BIC Graphic Europe il pioniere della stampa in digitale.

For all barrel colours

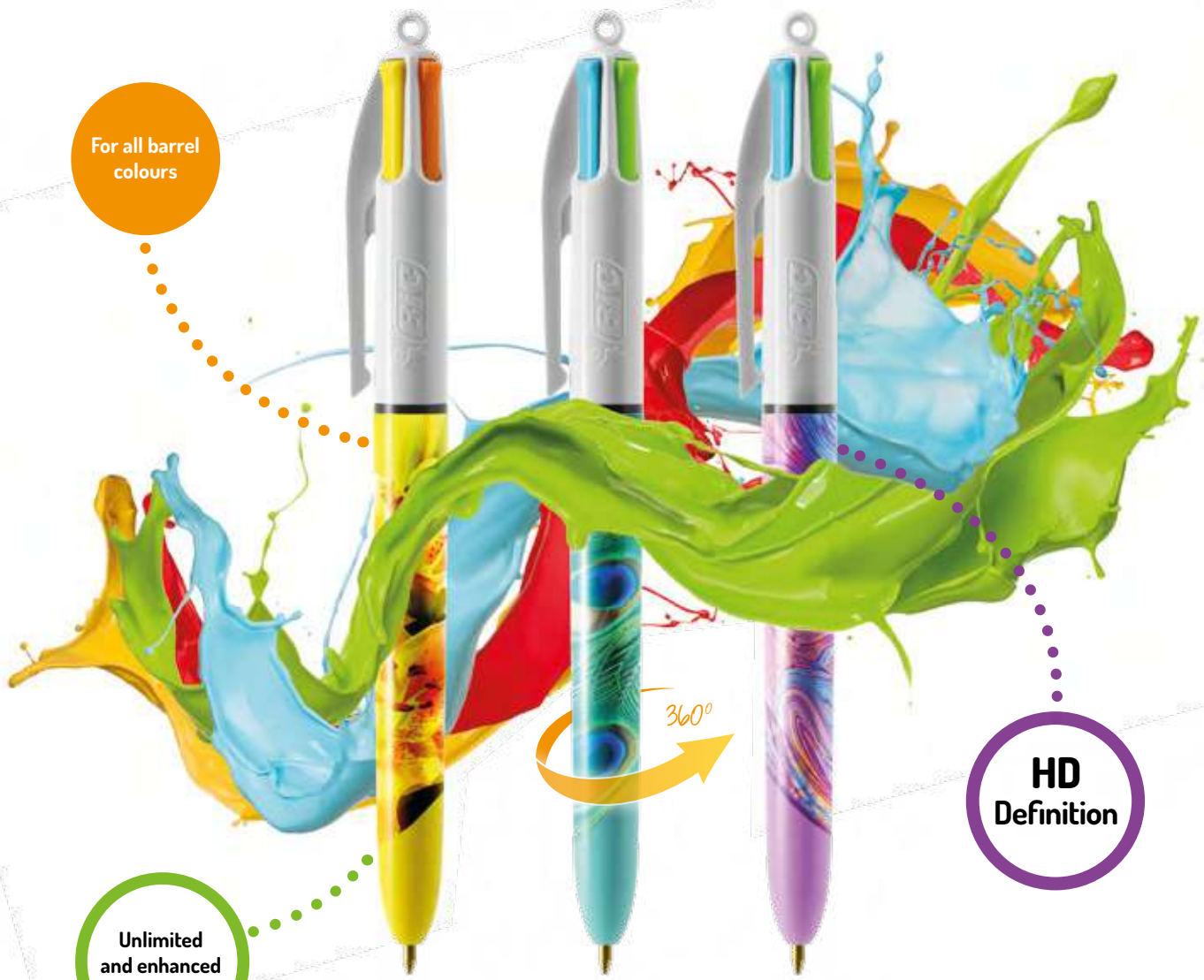

Unlimited and enhanced colours

HD Definition



\*\*GFK Panel - Western Europe 9 - MAT June 2018 - Sales in Value & Volume

**BIC** 4 COLOURS BRITEPIX™ DIGITAL *New!*

4 Colours - 1100

4 Colours Fashion - 1102

4 Colours Sun - 1097

4 Colours Fine - 1109



01/01

01/07

02/02



01/01

01/24

01/84

02/02



01/12



01/10



Colour ink  
Encre de couleur  
Color de la tinta  
Schreibfarbe  
Colore inchiostro



**BIC® 4 COLOURS**  
 Opaque - 1100  
 With Lanyard - 1101

*New colours!*



Colour ink

01/01



100%

02/02



01/03



01/05



01/02



01/07



*8000m of writing length*

Colour ink  
 Encre de couleur  
 Color de la tinta  
 Schreibfarbe  
 Colore inchiostro

FR > 8.000m d'écriture  
 ES > Escribe 8000m de longitud  
 DE > Schreiblänge 8000m  
 IT > 8000m di scrittura longitudinale

\*48h not available in Digital finishes 48h non disponibile in impression numérique / \*48h no disponibile en acabados digitales/ 48h bei digitalen Ausführungen nicht erhältlich / \*48h non disponibile in finiture digital . Available without lanyard Disponible sans tour de cou / Disponibile sin cordón / Erhältlich ohne Lanyard / Disponibile senza lanyard.

\*\* Source: GfK Panel - Western Europe 9 - MAT June 2018 - Sales in Value & Volume



## MOQ 250u.

### Decoration:

Personnalisation / Personalización / Dekoration / Decorazione

### BIC® 4 COLOURS

1100

**A SP:** max. 4 col.

**B DG:** Digital print (area for images)

**C BP:** full-colour

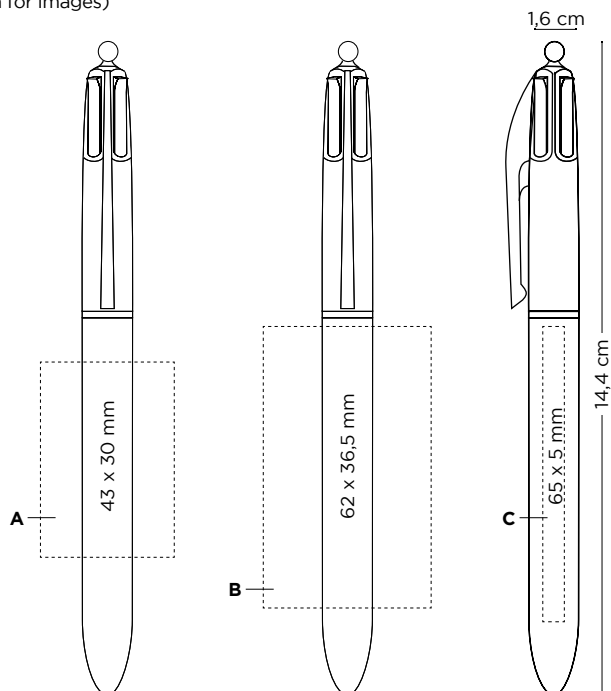

Price (€)

BIC® 4 COLOURS	100-249	250-499	500-999	1000-2499	2500-4999	5000-9999	10000-24999	25000-49999
1100								
<b>SP</b>	-	2,97	2,69	2,49	2,33	2,19	2,04	1,88
<b>DG</b>	-	4,06	3,68	3,41	3,17	3,00	2,78	2,58
<b>BP</b>	3,93	3,20	2,90	2,70	2,52	2,38	2,20	2,05
1101 (lanyard)								
<b>SP</b>	-	3,37	3,05	2,82	2,65	2,49	2,34	2,17
<b>DG</b>	-	4,46	4,04	3,74	3,49	3,30	3,08	2,87
<b>BP</b>	4,41	3,60	3,26	3,03	2,84	2,68	2,50	2,34

**Additional imprint charge per colour & position** Frais d'impression supplémentaires par couleur et position / Cargo por impresión adicional por color y posición / Zusätzliche druckkosten pro farbe & position / I prezzi includono la serigrafia ad 1 colore in una posizione.

<b>SP</b>	-	0,16	0,13	0,13	0,13	0,12	0,11	0,11
<b>BP</b>	0,25	0,23	0,21	0,20	0,19	0,18	0,16	0,15
<b>BP Texture</b>	0,19	0,17	0,15	0,14	0,14	0,13	0,12	0,12

**Prices include one imprint in one position according to specified technique.** Les prix incluent une impression sur un emplacement avec la technique spécifiée / Los precios incluyen una impresión en una posición acorde con la técnica especificada / In den Preisen inbegriffen ist ein Aufdruck auf einer Position gemäß angegebener Technik / I prezzi includono una stampa in una posizione a seconda della tecnica specificata.

### Writing modes:

Mode écriture /  
Modos de escritura /  
Schreibmodi /  
Modalità di scrittura

Ballpen



M

### Printing techniques:

Techniques d'impression /  
Técnicas de impresión /  
Drucktechniken /  
Tecniche di stampa



(SP)  
SCREEN  
PRINTING



(BP) britePix™



### New optional special packaging:

Nouvel emballage spécial en option /  
Nuevo envasado especial opcional /  
Neue optionale Verpackung / Nuove  
confezioni speciali opzionali



ECO Sleeve / Plastic Pouch / Window Box  
+ INFO pag. 306

### External packaging:

Emballage externe / Envasado  
exterior / Außenverpackung /  
Imballaggio esterno



250 ± 3,2 Kg

### Check out the video

Regardez la video /  
Mira el video /  
Produktvideo /  
Guarda il video



MADE IN  
FRANCE



www.bicgraphic.eu

107



**BIC® 4 COLOURS MINI**  
 Opaque - 1103  
 With Lanyard - 1104

**MOQ 250u.**

**Decoration:**

Personnalisation / Personalización / Dekoration / Decorazione

**BIC® 4 COLOURS MINI**

1103

**D SP:** max. 4 col.

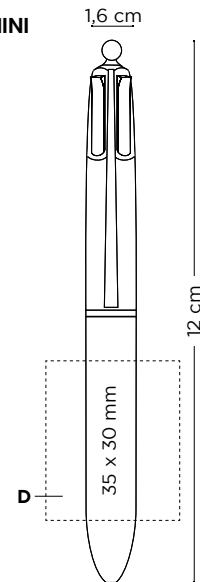

BIC® logo is embossed



01/04



Colour ink  
 Encre de couleur  
 Color de la tinta  
 Schreibfarbe  
 Colore inchiostro

01/01



Price (€)

BIC® 4 COLOURS MINI	250-499	500-999	1000-2499	2500-4999	5000-9999	10000-24999	25000-49999
1103							
<b>SP</b>	3,16	2,86	2,66	2,48	2,34	2,25	2,16
1104 (lanyard)							
<b>SP</b>	3,58	3,24	3,01	2,82	2,66	2,56	2,47

**Additional imprint charge per colour & position** Frais d'impression supplémentaires par couleur et position / Cargo por impresión adicional por color y posición / Zusätzliche druckkosten pro farbe & position / I prezzi includono la serigrafia ad 1 colore in una posizione.

<b>SP</b>	0,16	0,13	0,13	0,13	0,12	0,11	0,11
-----------	------	------	------	------	------	------	------

**Prices include 1 colour screenprint in one position.** Les prix incluent la sérigraphie 1 couleur sur un emplacement. En precio incluye un color en serigrafía en una posición. In den Preisen inbegriffen ist 1 Siebdruck-Farbaufdruck auf 1 Position. I prezzi includono 1 colore a serigrafia in una posizione.

**Writing modes:**

Mode écriture /  
 Modos de escritura /  
 Schreibmodi /  
 Modalità di scrittura

Ballpen



M

**Printing techniques:**

Techniques d'impression /  
 Técnicas de impresión /  
 Drucktechniken /  
 Tecniche di stampa



(SP)  
 SCREEN  
 PRINTING

**External packaging:**

Emballage externe / Envasado exterior / Außenverpackung / Imballaggio esterno



**250 ± 2,7 Kg**



\*48h not available in Digital finishes 48h non disponibile en impression numérique / \*48h no disponible en acabados digitales/ 48h bei digitalen Ausführungen nicht erhältlich / \*48h non disponibile in finiture digital . Available without lanyard Disponible sans tour de cou / Disponibile sin cordón / Erhältlich ohne Lanzard / Disponibile senza lanyard.



**BIC® 4 COLOURS SUN**  
Opaque - 1097  
With Lanyard - 1098

2 new  
flashy colours:  
orange & yellow

FR > 2 nouvelles couleurs flashy :orange et jaune  
ES > 2 nuevos colores llamativos: naranja y amarillo  
DE > 2 neue leuchtende Farben: orange & gelb  
IT > 2 nuovi vistosi colori: arancione e giallo



**MOQ 250u.**

**Decoration:**  
Personalisation /  
Personalización /  
Dekoration /  
Decorazione

**BIC® 4 COLOURS SUN**  
1097  
**A SP:** max. 4 col.  
**B DG:** Digital print  
(area for images)  
**C BP:** full-colour

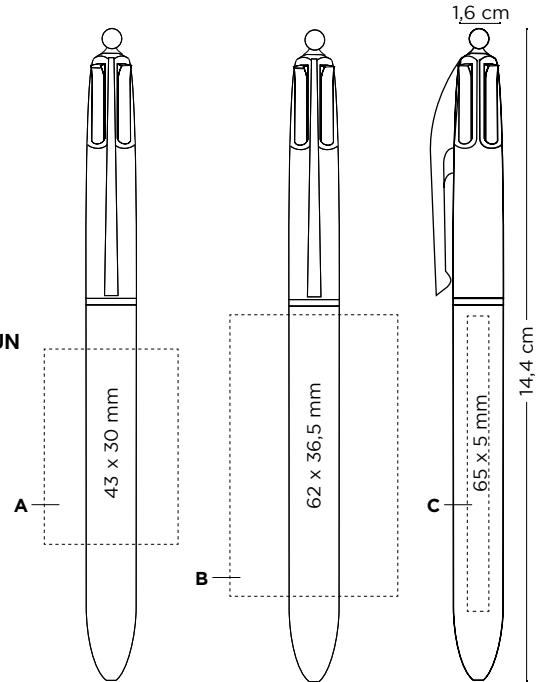

Price (€)

BIC® 4 COLOURS SUN	100-249	250-499	500-999	1000-2499	2500-4999	5000-9999	10000-24999	25000-49999
1097								
<b>SP</b>	-	2,97	2,69	2,49	2,33	2,19	2,04	1,88
<b>DG</b>	-	4,06	3,68	3,41	3,17	3,00	2,78	2,58
<b>BP</b>	3,93	3,20	2,90	2,70	2,52	2,38	2,20	2,05
1098 (lanyard)								
<b>SP</b>	-	3,37	3,05	2,82	2,65	2,49	2,34	2,17
<b>DG</b>	-	4,46	4,04	3,74	3,49	3,30	3,08	2,87
<b>BP</b>	4,41	3,60	3,26	3,03	2,84	2,68	2,50	2,34

**Additional imprint charge per colour & position** Frais d'impression supplémentaires par couleur et position / Cargo por impresión adicional por color y posición / Zusätzliche druckkosten pro farbe & position / I prezzi includono la serigrafia ad 1 colore in una posizione.

<b>SP</b>	-	0,16	0,13	0,13	0,13	0,12	0,11	0,11
<b>BP</b>	0,25	0,23	0,21	0,20	0,19	0,18	0,16	0,15
<b>BP Texture</b>	0,19	0,17	0,15	0,14	0,14	0,13	0,12	0,12

**Prices include one imprint in one position according to specified technique.** Les prix incluent une impression sur un emplacement avec la technique spécifiée / Los precios incluyen una impresión en una posición acorde con la técnica especificada / In den Preisen inbegriffen ist ein Aufdruck auf einer Position gemäß angegebener Technik / I prezzi includono una stampa in una posizione a seconda della tecnica specificata.

Colour ink  
Encre de couleur  
Color de la tinta  
Schreibfarbe  
Colore inchiostro

01/12

01/12

100%

**Writing modes:**

Mode écriture / Modos de escritura / Schreibmodi / Modalità di scrittura

**Printing techniques:**

Techniques d'impression / Técnicas de impresión / Drucktechniken / Tecniche di stampa

**New optional special packaging:**

Nouvel emballage spécial en option / Nuevo envasado especial opcional / Neue optionale Verpackung / Nuove confezioni speciali opzionali

**External packaging:**

Emballage externe / Envasado exterior / Außenverpackung / Imballaggio esterno

Ballpen



M



(SP) SCREEN PRINTING



(BP) britePix™



ECO Sleeve / Plastic Pouch / Window Box  
+ INFO pag. 306



250 ± 3,2 Kg



MADE IN FRANCE



\*48h not available in Digital finishes 48h non disponibile in impression numérique / \*48h no disponibile in acabados digitales/ 48h bei digitalen Ausführungen nicht erhältlich / \*48h non disponibile in finiture digital. Available without lanyard Disponible sans tour de cou / Disponible sin cordón / Erhältlich ohne Lanzard / Disponibile senza lanyard.



Fashion inks!

**BIC® 4 COLOURS FASHION**  
 Opaque - 1102  
 With Lanyard - 1108



Colour ink  
 Encre de couleur  
 Color de la tinta  
 Schreibfarbe  
 Colore inchiostro

01/01

01/24

01/84

02/02

FR > Encres fantaisie ES > iTintas a la moda! DE > Modische Tintenfarben! IT > Colori fashion!



\*48h not available in Digital finishes 48h non disponible en impression numérique / \*48h no disponible en acabados digitales/ 48h bei digitalen Ausführungen nicht erhältlich / \*48h non disponibile in finiture digital . Available without lanyard Disponible sans tour de cou / Disponible sin cordón / Erhältlich ohne Lanzard / Disponibile senza lanyard.



## MOQ 250u.

### Decoration:

Personalisation / Personalización / Dekoration / Decorazione

### BIC® 4 COLOURS FASHION

1102

**A SP:** max. 4 col.

**B DG:** Digital print (area for images)

**C BP:** full-colour

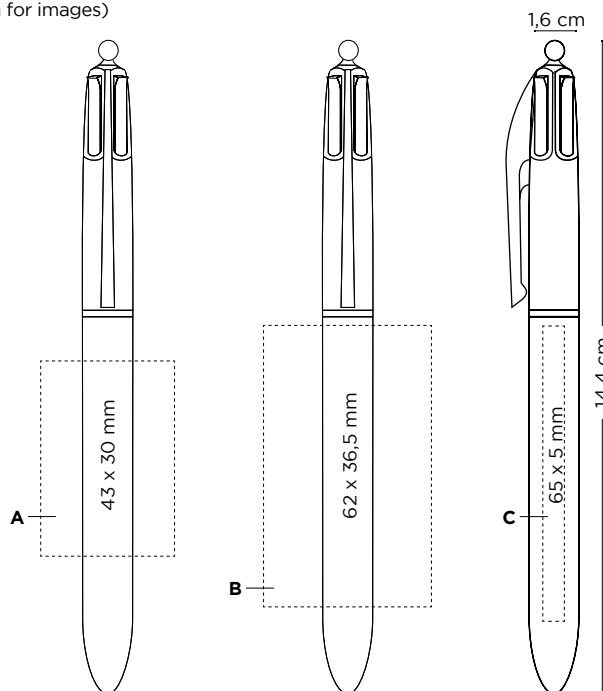

Price (€)

BIC® 4 COLOURS FASHION	100-249	250-499	500-999	1000-2499	2500-4999	5000-9999	10000-24999	25000-49999
1102								
<b>SP</b>	-	2,97	2,69	2,49	2,33	2,19	2,04	1,88
<b>DG</b>	-	4,06	3,68	3,41	3,17	3,00	2,78	2,58
<b>BP</b>	3,93	3,20	2,90	2,70	2,52	2,38	2,20	2,05

1108 (lanyard)

<b>SP</b>	-	3,37	3,05	2,82	2,65	2,49	2,34	2,17
<b>DG</b>	-	4,46	4,04	3,74	3,49	3,30	3,08	2,87
<b>BP</b>	4,41	3,60	3,26	3,03	2,84	2,68	2,50	2,34

**Additional imprint charge per colour & position** Frais d'impression supplémentaires par couleur et position / Cargo por impresión adicional por color y posición / Zusätzliche druckkosten pro farbe & position / I prezzi includono la serigrafia ad 1 colore in una posizione.

<b>SP</b>	-	0,16	0,13	0,13	0,13	0,12	0,11	0,11
<b>BP</b>	0,25	0,23	0,21	0,20	0,19	0,18	0,16	0,15
<b>BP Texture</b>	0,19	0,17	0,15	0,14	0,14	0,13	0,12	0,12

**Prices include one imprint in one position according to specified technique.** Les prix incluent une impression sur un emplacement avec la technique spécifiée / Los precios incluyen una impresión en una posición acorde con la técnica especificada / In den Preisen inbegriffen ist ein Aufdruck auf einer Position gemäß angegebener Technik / I prezzi includono una stampa in una posizione a seconda della tecnica specificata.

### Writing modes:

Mode écriture /  
Modos de escritura /  
Schreibmodi /  
Modalità di scrittura

Ballpen



M

### Printing techniques:

Techniques d'impression /  
Técnicas de impresión /  
Drucktechniken /  
Tecniche di stampa



(SP)  
SCREEN  
PRINTING



(BP) britePix™



### New optional special packaging:

Nouvel emballage spécial en option /  
Nuevo envasado especial opcional /  
Neue optionale Verpackung /  
Nuove confezioni speciali opzionali



ECO Sleeve / Plastic Pouch / Window Box

+ INFO pag. 306

### External packaging:

Emballage externe / Envasado exterior / Außenverpackung / Imballaggio esterno



250 ± 3,2 Kg



MADE IN  
FRANCE

www.bicgraphic.eu

111



BIC® 4 COLOURS SHINE  
Opaque - 1106  
With Lanyard - 1107



super shiny barrels!

01/75

01/26

01/34

01/7G

Colour ink  
Encre de couleur  
Color de la tinta  
Schreibfarbe  
Colore inchiostro



FR > Corps super brillant ! ES > Cuerpos super brillantes! DE > Super glänzende Schäfte! IT > Fusti super brillanti!



## MOQ 250u.

### Decoration:

Personalisation / Personalización / Dekoration / Decorazione

### BIC® 4 COLOURS SHINE

1106

**A SP:** max. 2 col.

**B LE**

**C LE**

**D LE 360°**

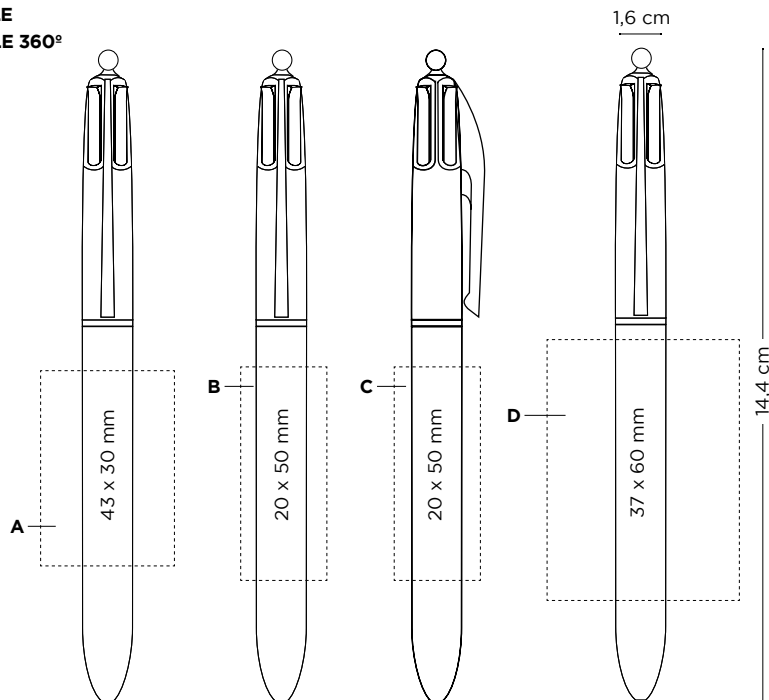

Price (€)

BIC® 4 COLOURS SHINE	250-499	500-999	1000-2499	2500-4999	5000-9999	10000-24999	25000-49999
1106							
<b>SP</b>	3,40	3,06	2,84	2,66	2,49	2,32	2,15
<b>LE</b>	4,17	3,76	3,49	3,25	3,07	2,84	2,64
<b>LE 360°</b>	4,74	4,26	3,97	3,70	3,48	3,22	3,11
1107 (lanyard)							
<b>SP</b>	3,82	3,44	3,19	3,00	2,81	2,63	2,46
<b>LE</b>	4,59	4,14	3,84	3,59	3,39	3,16	2,95
<b>LE 360°</b>	5,16	4,65	4,32	4,04	3,80	3,54	3,42

**Additional imprint charge per colour & position** Frais d'impression supplémentaires par couleur et position / Cargo por impresión adicional por color y posición / Zusätzliche druckkosten pro farbe & position / I prezzi includono la serigrafia ad 1 colore in una posizione.

SP	0,16	0,13	0,13	0,13	0,12	0,11	0,11
----	------	------	------	------	------	------	------

**Prices include one imprint in one position according to specified technique.** Les prix incluent une impression sur un emplacement avec la technique spécifiée / Los precios incluyen una impresión en una posición acorde con la técnica especificada / In den Preisen inbegriffen ist ein Aufdruck auf einer Position gemäß angegebener Technik / I prezzi includono una stampa in una posizione a seconda della tecnica specificata.

① Price under request. Prix sur demande. Precio bajo consulta. Preis auf Anfrage. Prezzi su richiesta.

### Writing modes:

Mode écriture /  
Modos de escritura /  
Schreibmodi /  
Modalità di scrittura

Ballpen



M

### Printing techniques:

Techniques d'impression /  
Técnicas de impresión /  
Drucktechniken /  
Tecniche di stampa



(SP)  
SCREEN  
PRINTING



(LE)  
LASER

### New optional special packaging:

Nouvel emballage spécial en option /  
Nuevo envasado especial opcional /  
Neue optionale Verpackung / Nuove  
confezioni speciali opzionali



ECO Sleeve / Plastic Pouch / Window Box

+ INFO pag. 306

### External packaging:

Emballage externe / Envasado  
exterior / Außenverpackung /  
Imballaggio esterno



250 ± 3,2 Kg



MADE IN  
FRANCE

www.bicgraphic.eu

113



**BIC® 4 COLOURS FINE**  
 Opaque - 1109  
 With Lanyard - 1111



**MOQ 250u.**

**Decoration:**

Personalisation /  
 Personalización /  
 Dekoration /  
 Decorazione

**BIC® 4 COLOURS FINE**

1109

- A SP:** max. 4 col.
- B DG:** Digital print
- C BP:** full-colour

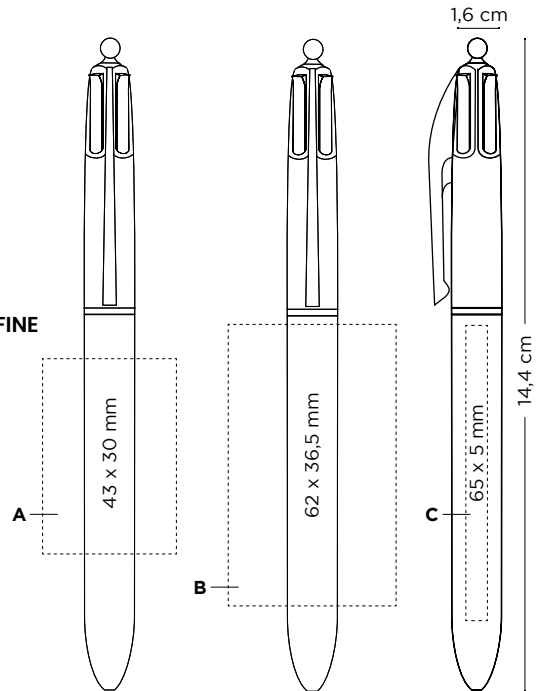

Price (€)

BIC® 4 COLOURS FINE	100-249	250-499	500-999	1000-2499	2500-4999	5000-9999	10000-24999	25000-49999
1109								
<b>SP</b>	-	2,97	2,69	2,49	2,33	2,19	2,04	1,88
<b>DG</b>	-	4,06	3,68	3,41	3,17	3,00	2,78	2,58
<b>BP</b>	3,93	3,20	2,90	2,70	2,52	2,38	2,20	2,05
1111 (lanyard)								
<b>SP</b>	-	3,37	3,05	2,82	2,65	2,49	2,34	2,17
<b>DG</b>	-	4,46	4,04	3,74	3,49	3,30	3,08	2,87
<b>BP</b>	4,41	3,60	3,26	3,03	2,84	2,68	2,50	2,34

**Additional imprint charge per colour & position** Frais d'impression supplémentaires par couleur et position / Cargo por impresión adicional por color y posición / Zusätzliche druckkosten pro farbe & position / I prezzi includono la serigrafia ad 1 colore in una posizione.

<b>SP</b>	-	0,16	0,13	0,13	0,13	0,12	0,11	0,11
<b>BP</b>	0,25	0,23	0,21	0,20	0,19	0,18	0,16	0,15
<b>BP Texture</b>	0,19	0,17	0,15	0,14	0,14	0,13	0,12	0,12

**Prices include one imprint in one position according to specified technique.** Les prix incluent une impression sur un emplacement avec la technique spécifiée / Los precios incluyen una impresión en una posición acorde con la técnica especificada / In den Preisen inbegriffen ist ein Aufdruck auf einer Position gemäß angegebener Technik / I prezzi includono una stampa in una posizione a seconda della tecnica specificata.

Colour ink  
 Encre de couleur  
 Color de la tinta  
 Schreibfarbe  
 Colore inchiostro

01/10

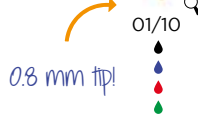

**Writing modes:**

Mode écriture / Modos de escritura / Schreibmodi / Modalità di scrittura

**Printing techniques:**

Techniques d'impression / Técnicas de impresión / Drucktechniken / Tecniche di stampa

**New optional special packaging:**

Nouvel emballage spécial en option / Nuevo envasado especial opcional / Neue optionale Verpackung / Nuove confezioni speciali opzionali

**External packaging:**

Emballage externe / Envasado exterior / Außenverpackung / Imballaggio esterno

Ballpen



F



(SP) SCREEN PRINTING



(BP) britePix™



ECO Sleeve / Plastic Pouch / Window Box



250 ± 3,2 Kg



MADE IN FRANCE



+ INFO pag. 306

\*48h not available in Digital finishes 48h non disponibile in impression numérique / \*48h no disponible en acabados digitales / 48h bei digitalen Ausführungen nicht erhältlich / \*48h non disponibile in finiture digital. Available without lanyard Disponible sans tour de cou / Disponibile sin cordón / Erhältlich ohne Lanzard / Disponibile senza lanyard.



**BIC® 4 COLOURS FLUO**

Opaque - 1114  
With Lanyard - 1116

FR > Encre jaune fluo !  
ES > ¡Tinta amarilla fluo!  
DE > Neongelbe Tinte!  
IT > Inchiostro giallo fluo!

Fluo yellow ink!

**MOQ 250u.**

**Decoration:**

Personalisation /  
Personalización /  
Dekoration /  
Decorazione

**BIC® 4 COLOURS FLUO**

1114

**A SP:** max. 4 col.

**B BP:** full-colour

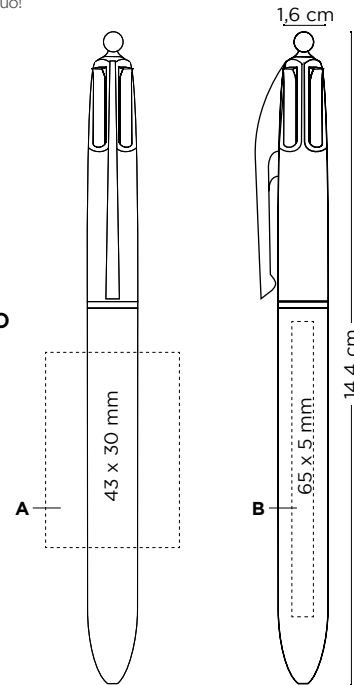

01/4D

01/4D

Colour ink  
Encre de couleur  
Color de la tinta  
Schreibfarbe  
Colore inchiostro



Price (€)

BIC® 4 COLOURS FLUO	100-249	250-499	500-999	1000-2499	2500-4999	5000-9999	10000-24999	25000-49999
1114								
<b>SP</b>	-	3,21	2,90	2,69	2,51	2,38	2,19	2,05
<b>BP</b>	4,23	3,45	3,12	2,89	2,71	2,56	2,37	2,20
1116 (lanyard)								
<b>SP</b>	-	3,64	3,29	3,04	2,85	2,70	2,51	2,36
<b>BP</b>	4,71	3,87	3,50	3,24	3,05	2,88	2,68	2,51

**Additional imprint charge per colour & position** Frais d'impression supplémentaires par couleur et position / Cargo por impresión adicional por color y posición / Zusätzliche druckkosten pro farbe & position / I prezzi includono la serigrafia ad 1 colore in una posizione.

<b>SP</b>	-	0,16	0,13	0,13	0,13	0,12	0,11	0,11
<b>BP</b>	0,25	0,23	0,21	0,20	0,19	0,18	0,16	0,15
<b>BP Texture</b>	0,19	0,17	0,15	0,14	0,14	0,13	0,12	0,12

**Prices include one imprint in one position according to specified technique.** Les prix incluent une impression sur un emplacement avec la technique spécifiée / Los precios incluyen una impresión en una posición acorde con la técnica especificada / In den Preisen inbegriffen ist ein Aufdruck auf einer Position gemäß angegebener Technik / I prezzi includono una stampa in una posizione a seconda della tecnica specificata.

**Writing modes:**

Mode écriture / Modos de escritura / Schreibmodi / Modalità di scrittura

**Printing techniques:**

Techniques d'impression / Técnicas de impresión / Drucktechniken / Tecniche di stampa

**New optional special packaging:**

Nouvel emballage spécial en option / Nuevo envasado especial opcional / Neue optionale Verpackung / Nuove confezioni speciali opzionali

**External packaging:**

Emballage externe / Envasado exterior / Außenverpackung / Imballaggio esterno

Ballpen



B



(SP) SCREEN PRINTING



(BP) britePix™  
BritePix  
BritePix  
BritePix



ECO Sleeve / Plastic Pouch / Window Box + INFO pag. 306



250 ± 3,2 Kg



MADE IN FRANCE



\*48h not available in Digital finishes 48h non disponibile in impression numérique / \*48h no disponibile in acabados digitales / 48h bei digitalen Ausführungen nicht erhältlich / \*48h non disponibile in finiture digital. Available without lanyard  
Disponibile senza tour de cou / Disponibile sin cordón / Erhältlich ohne Lanzard / Disponibile senza lanyard.



**BIC® 4 COLOURS SYLUS**  
Opaque - 1112

soft pad for touchscreen!

FR > Cliquet en caoutchouc pour écran tactile !  
ES > ¡Almohadilla suave para pantallas táctiles!  
DE > Weiches Pad für Touchscreens  
IT > Punta morbida per touchscreen!



02/02

Colour ink  
Encre de couleur  
Color de la tinta  
Schreibfarbe  
Colore inchiostro

02/02



**MOQ 250u.**

**Decoration:**

Personnalisation /  
Personalización /  
Dekoration /  
Decorazione

**BIC® 4 COLOURS SYLUS**

1112

**A SP:** max. 1 col.

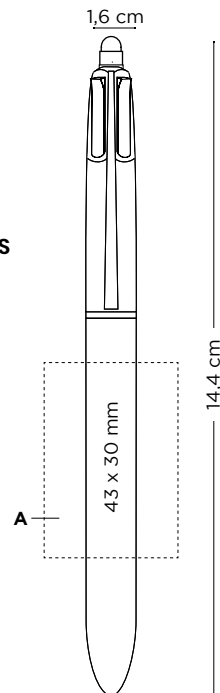

Price (€)

BIC® 4 COLOURS SYLUS 1112	250-499	500-999	1000-2499	2500-4999	5000-9999	10000-24999	25000-49999
<b>SP</b>	3,53	3,19	2,96	2,77	2,61	2,47	2,34

**Prices include 1 colour screenprint in one position.** Les prix incluent la sérigraphie 1 couleur sur un emplacement / En precio incluye un color en serigrafía en una posición / In den Preisen inbegriffen ist 1 Siebdruck-Farbaufdruck auf 1 Position / I prezzi includono 1 colore a serigrafia in una posizione.

**Writing modes:**

Mode écriture /  
Modos de escritura /  
Schreibmodi /  
Modalità di scrittura

Ballpen



M

**Printing techniques:**

Techniques d'impression /  
Técnicas de impresión /  
Drucktechniken /  
Tecniche di stampa



(SP)  
SCREEN  
PRINTING

**New optional special packaging:**

Nouvel emballage spécial en option /  
Nuevo envasado especial opcional /  
Neue optionale Verpackung /  
Nuove confezioni speciali opzionali



Plastic Pouch  
+ INFO pag. 306

**External packaging:**

Emballage externe / Envasado exterior /  
Außenverpackung /  
Imballaggio esterno



**250 ± 3,2 Kg**





**BIC® 4 COLOURS 3+1<sup>HB</sup>**  
Opaque - 1099



01/06

Colour ink  
Encre de couleur  
Color de la tinta  
Schreibfarbe  
Colore inchiostro



01/06



100%

**MOQ 250u.**

**Decoration:**

Personnalisation /  
Personalización /  
Dekoration /  
Decorazione

**BIC® 4 COLOURS 3+1<sup>HB</sup>**

1099  
A/B LE

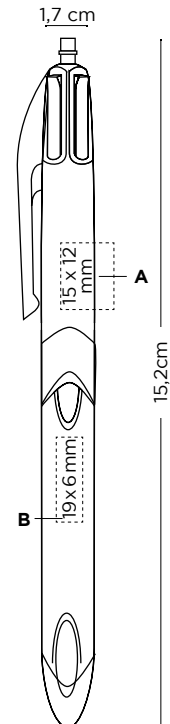

Price (€)

BIC® 4 COLOURS 3+1 <sup>HB</sup>	250-499	500-999	1000-2499	2500-4999	5000-9999	10000-24999	25000-49999
1099							
LE	4,47	4,03	3,75	3,49	3,30	3,17	3,06

**Additional imprint charge per imprint & position** Frais d'impression supplémentaires par couleur et position / Cargo por impresión adicional por color y posición / Zusätzliche druckkosten pro farbe & position / I prezzi includono la serigrafia ad 1 colore in una posizione.

LE	1,21	1,09	0,96	0,96	0,96	0,96	0,96
----	------	------	------	------	------	------	------

**Price includes 1 laser engraving in 1 position.** Le prix comprend 1 gravure laser en 1 position / El precio incluye 1 grabado láser en una posición / Preise beinhalten eine Lasergravur an einer Position / Il prezzo comprende 1 incisione laser in 1 posizione.

**Writing modes:**

Mode écriture /  
Modos de escritura /  
Schreibmodi /  
Modalità di scrittura

Ballpen &  
Mechanical pencil



**M-MP**  
Ø0,7mm

**Printing techniques:**

Techniques d'impression /  
Técnicas de impresión /  
Drucktechniken /  
Tecniche di stampa



(LE)  
LASER

**New optional special packaging:**

Nouvel emballage spécial en option /  
Nuevo envasado especial opcional /  
Neue optionale Verpackung / Nuove  
confezioni speciali opzionali



Plastic Pouch  
+ INFO pag. 306

**External packaging:**

Emballage externe /  
Envasado exterior /  
Außenverpackung /  
Imballaggio esterno



**250 ± 3,5 Kg**

**Check out the video**

Regardez la video /  
Mira el video /  
Produktvideo /  
Guarda il video



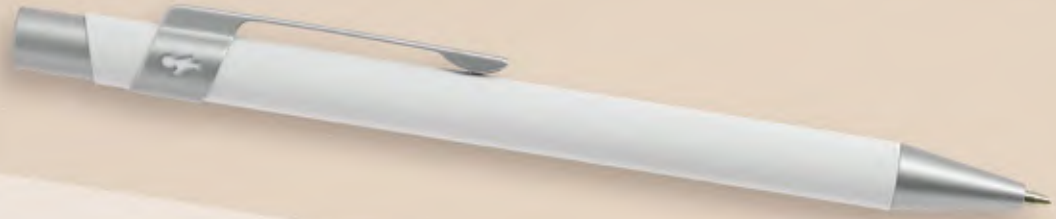





Metal accents, modern design with a large selection of colors and finishes. Maximum writing comfort, large German metal refill.

FR > Détails métalliques, design moderne avec un grand choix de couleurs et de finitions. Confort d'écriture maximal, encre rechargeable allemande.

ES > Detalles metálicos, diseño moderno con una gran selección de colores y acabados. Máximo confort de escritura, tinta recargable alemana.

DE > Unser kultiger BIC® Round Stic® bietet zeitloses Design in hoher Qualität. Sein klassisches Design ist einfach zu erkennen und steht für lang anhaltende Zuverlässigkeit.

IT > Particolari metallici, design moderno e con una ampia selezione di colori e finiture. Massimo confort di scrittura, grande refill Tedesco in metallo.



New!

Soft - 1290



01

10

03

04

08

02

05

Colour ink  
 Encre de couleur  
 Color de la tinta  
 Schreibfarbe  
 Colore inchiostro



Polished -  
1290



01

03

05

04

08

02

Colour ink  
Encre de couleur  
Color de la tinta  
Schreibfarbe  
Colore inchiostro

10

New!

Matt - 1290



01

10

03

05

04

08

02

Colour ink  
Encre de couleur  
Color de la tinta  
Schreibfarbe  
Colore inchiostro





## MOQ 50u.

### Decoration:

Personnalisation / Personalización / Dekoration / Decorazione

### BIC® METAL PRO

1290

**A SP:** max. 2 col.

(Not available in soft finish)

**B LE/SP:** max. 1 col.

**C LE 360°**

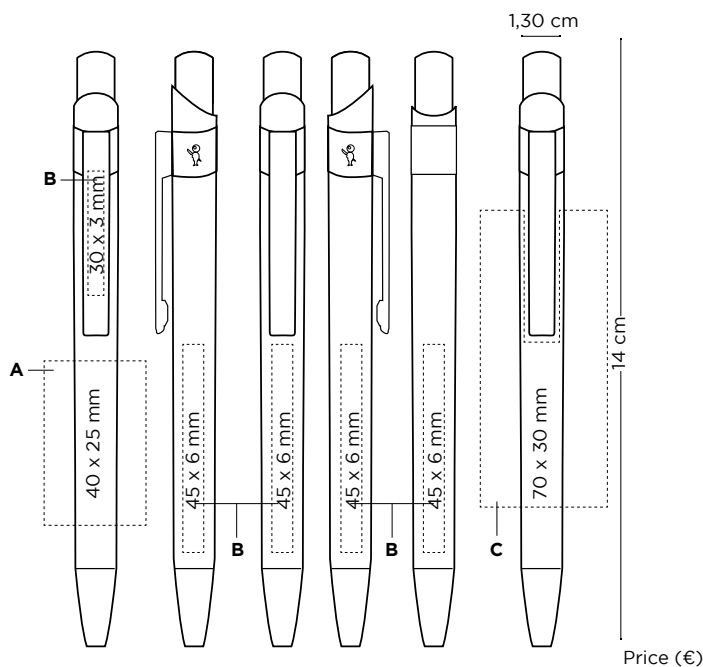

BIC® METAL PRO	50-99	100-249	250-499	500-999	1000-2499	2500-4999	5000-9999
1290							
<b>SP</b>	4,35	4,20	4,04	3,88	3,68	3,54	3,41
<b>LE</b>	5,50	5,15	4,92	4,69	4,43	4,29	4,16
<b>LE 360° (MOQ 100u.)</b>	-	6,23	5,90	5,57	5,20	5,06	4,93

**Additional imprint charge per colour & position** Frais d'impression supplémentaires par couleur et position / Cargo por impresión adicional por color y posición / Zusätzliche druckkosten pro farbe & position / Costo marchio aggiuntivo per colore e posizione.

<b>SP</b>	0,43	0,40	0,35	0,30	0,21	0,21	0,21
<b>LE</b>	1,58	1,35	1,23	1,11	0,96	①	①

**Prices include one imprint in one position according to specified technique.** Les prix incluent une impression sur un emplacement avec la technique spécifiée / Los precios incluyen una impresión en una posición acorde con la técnica especificada / In den Preisen inbegriffen ist ein Aufdruck auf einer Position gemäß angegebener Technik / I prezzi includono una stampa in una posizione a seconda della tecnica specificata.

① Price under request. Prix sur demande. Precio bajo consulta. Preis auf Anfrage. Prezzi su richiesta.

### Writing modes:

Mode écriture / Modos de escritura / Schreibmodi / Modalità di scrittura

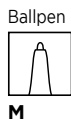

### Printing techniques:

Techniques d'impression / Técnicas de impresión / Drucktechniken / Tecniche di stampa



### New optional special packaging:

Nouvel emballage spécial en option / Nuevo envasado especial opcional / Neue optionale Verpackung / Nuove confezioni speciali opzionali



ECO Sleeve / Plastic Pouch / Window Box

### External packaging:

Emballage externe / Envasado exterior / Außenverpackung / Imballaggio esterno



150 ± 2,5 Kg



MADE IN GERMANY



Enjoy a smooth writing experience. Glide across the paper easily without smudging thanks to the quick-drying ink, ideal for both left and right-handed people.

FR > Profitez d'une expérience d'écriture fluide. Parfait pour les droitiers comme pour les gauchers, il glisse facilement sur le papier et ne fait pas de tâches grâce à son encre à séchage rapide.

DE > Genießen Sie ein weiches Schreibgefühl. Gleiten Sie über das Papier ohne dass etwas verschmieren kann, dank der schnelltrocknenden Tinte - ideal für Links- und Rechtshänder

ES > Disfruta de una experiencia de escritura suave. Se desliza fácilmente a través del papel y sin manchas gracias a la tinta de secado rápido, ideal tanto para las personas zurdas como diestras.

IT > Goditi un'esperienza di scrittura morbidissima. Scorre facilmente sulla carta senza macchiare grazie all'inchiostro ad asciugatura immediata, ideale per mancini e destrorsi







High quality medium point liquid ink roller pen for smooth and fluid writing

**BIC® GRIP ROLLER**  
1187



01/35    12/35    10/35    03/35    08/35    14/35    59/35    24/35    07/35    06/35    27/35    02/35

Colour ink  
Encre de couleur  
Color de la tinta  
Schreibfarbe  
Colore inchiostro





## MOQ 250u.

### Decoration:

Personnalisation / Personalización / Dekoration / Decorazione

### BIC® GRIP ROLLER

1187

A/B SP: max. 3 col.

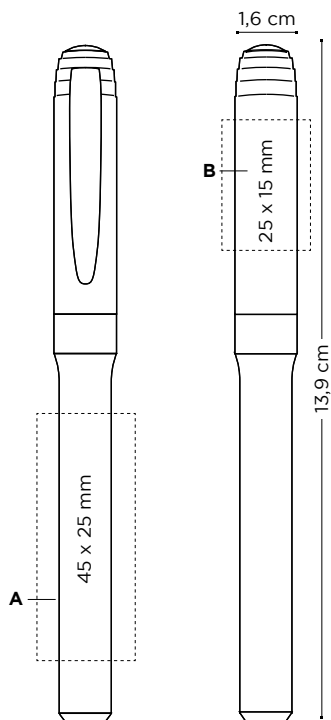

	Price (€)						
<b>BIC® GRIP ROLLER</b>	250-499	500-999	1000-2499	2500-4999	5000-9999	10000-24999	25000-49999
1187							
<b>SP</b>	1,68	1,51	1,41	1,31	1,23	①	①

**Additional imprint charge per colour & position** Frais d'impression supplémentaires par couleur et position / Cargo por impresión adicional por color y posición / Zusätzliche druckkosten pro farbe & position / Costo marchio aggiuntivo per colore e posizione.

<b>SP</b>	0,16	0,13	0,13	0,13	0,12	①	①
-----------	------	------	------	------	------	---	---

**Prices include 1 colour screenprint in one position.** Les prix incluent la sérigraphie 1 couleur sur un emplacement / En precio incluye un color en serigrafía en una posición / In den Preisen inbegriffen ist 1 Siebdruck-Farbaufdruck auf 1 Position / I prezzi includono la serigrafia ad 1 colore in una posizione.  
 ① Price under request. Prix sur demande. Precio bajo consulta. Preis auf Anfrage. Prezzi su richiesta.

### Writing modes:

Mode écriture /  
Modos de escritura /  
Schreibmodi /  
Modalità di scrittura

Roller



**R**  
Ø0,7mm

### Printing techniques:

Techniques d'impression /  
Técnicas de impresión /  
Drucktechniken /  
Tecniche di stampa



(SP)  
SCREEN  
PRINTING

### New optional special packaging:

Nouvel emballage spécial en option /  
Nuevo envasado especial opcional /  
Neue optionale Verpackung / Nuove  
confezioni speciali opzionali



ECO Sleeve / Plastic Pouch / Window Box / Marking Set

+ INFO pag. 306 & 307

### External packaging:

Emballage externe / Envasado  
exterior / Außenverpackung /  
Imballaggio esterno



**250 ± 3 Kg**





*New Colour!*  
*New Colour!*  
*New Colour!*

Opaque - 1851

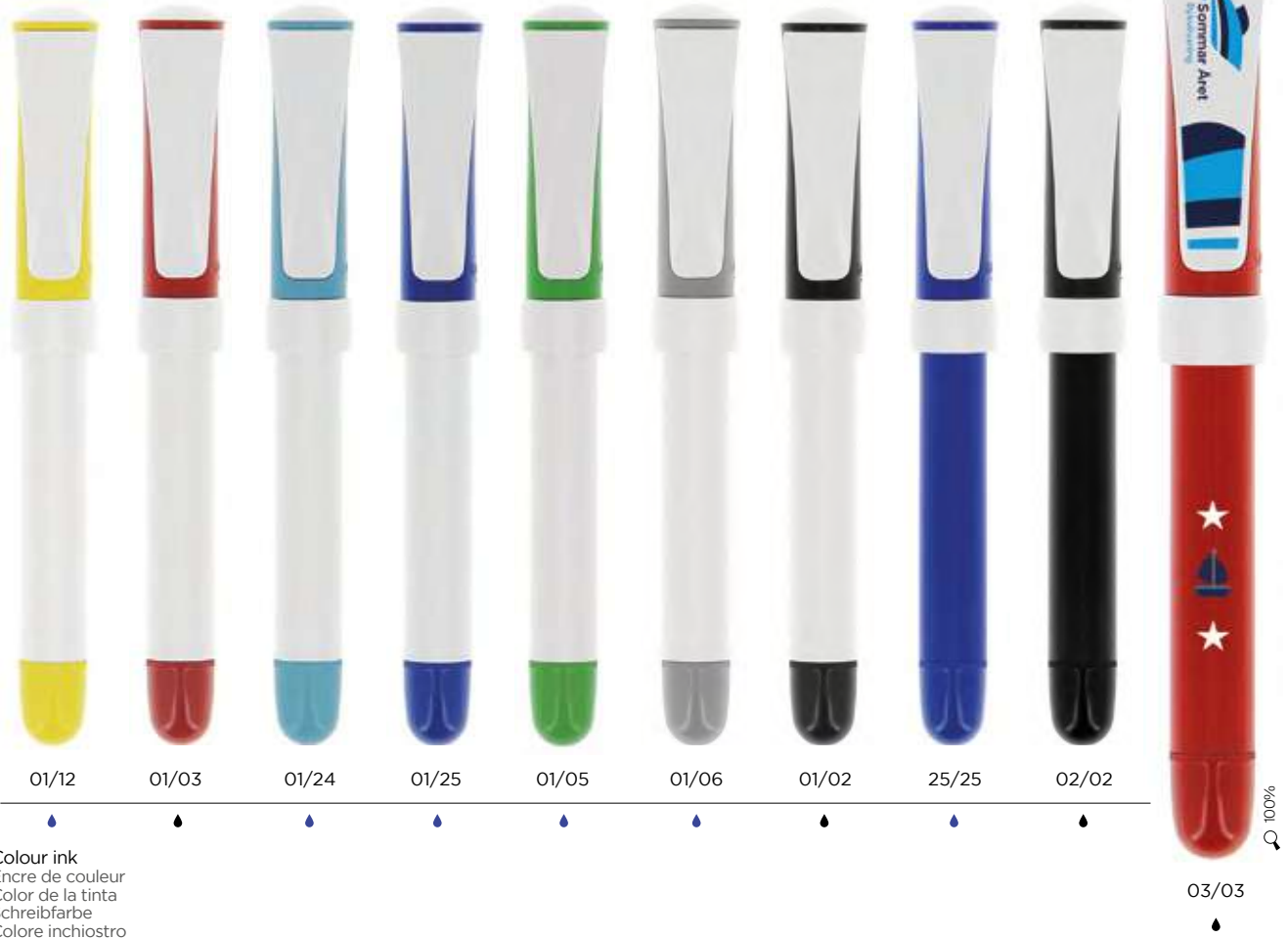

Colour ink  
 Encre de couleur  
 Color de la tinta  
 Schreibfarbe  
 Colore inchiostro

\*48h not available for britePix™ decoration 48h non disponibile in impression britePix™ / \*48h no disponible para personalización britePix™ / \*britePix™  
 Druck ausgeschlossen / \*48 h non disponibile per personalizzazione britePix™

BIC® Writing instruments • ROLLER & GELS

**MOQ 250u.**

**Decoration:**

Personnalisation / Personalización / Dekoration / Decorazione

Opaque /Clear -  
1851



01/89



**BIC® XS FINESTYLE**

1851

**A PD:** max 2 col.

**B SP:** max 2 col.

**C BP:** full-colour

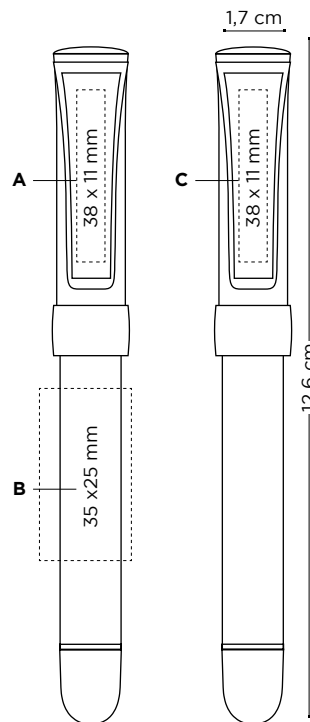

Price (€)

BIC® XS FINESTYLE	250-499	500-999	1000-2499	2500-4999	5000-9999	10000-24999	25000-49999
1851							
<b>SP/PD</b>	1,71	1,56	1,46	1,36	1,26	①	①
<b>BP</b>	1,94	1,77	1,66	1,55	1,44	①	①

**Additional imprint charge per colour & position** Frais d'impression supplémentaires par couleur et position / Cargo por impresión adicional por color y posición / Zusätzliche druckkosten pro farbe & position / Costo marchio aggiuntivo per colore e posizione.

<b>SP/PD</b>	0,16	0,13	0,13	0,13	0,12	①	①
<b>BP Texture</b>	0,17	0,15	0,14	0,14	0,13	①	①

**Prices include one imprint in one position according to specified technique.** Les prix incluent une impression sur un emplacement avec la technique spécifiée / Los precios incluyen una impresión en una posición acorde con la técnica especificada / In den Preisen inbegriffen ist ein Aufdruck auf einer Position gemäß angegebener Technik / I prezzi includono una stampa in una posizione seconda della tecnica specificata.

① Price under request. Prix sur demande. Precio bajo consulta. Preis auf Anfrage. Prezzi su richiesta.

**Exact colour match:**

Correspondance exacte des couleurs / Color exacto / Exakte Farbübereinstimmung / Esatta corrispondenza di colore

**≥ 10.000 units**

**Writing modes:**

Mode écriture / Modos de escritura / Schreibmodi / Modalità di scrittura

Finestyle



**FS**  
Ø0,7mm

**Printing techniques:**

Techniques d'impression / Técnicas de impresión / Drucktechniken / Tecniche di stampa



(SP) SCREEN PRINTING



(PD) PAD PRINTING



(BP) britePix™



**New optional special packaging:**

Nouvel emballage spécial en option / Nuevo envasado especial opcional / Neue optionale Verpackung / Nuove confezioni speciali opzionali



ECO Sleeve / Plastic Pouch

+ INFO pag. 306

**External packaging:**

Emballage externe / Envasado exterior / Außenverpackung / Imballaggio esterno



**250 ± 2,8 Kg**



**MADE IN SPAIN**

www.bicgraphic.eu

**129**



Live the smooth writing with the BIC® gel ink pens. Comfort meets superior handling with a rubber grip, easy to grab and feel even more comfortable while writing.

FR > Vivez l'écriture en douceur avec les stylos à encre gel BIC®. Il combine le confort et la souplesse pour une prise en main agréable à l'heure d'écrire.

ES > Vive la suave escritura con los bolígrafos BIC® de tinta gel. El confort y el manejo superior con el mangod e coma, fácil de agarrar y se siente más cómodo a la hora de escribir.

DE > Genießen Sie ein weiches Schreibgefühl. Gleiten Sie über das Papier ohne dass etwas verschmieren kann, dank der schnelltrocknenden Tinte - ideal für Links- und Rechtshänder

IT > Goditi una scrittura morbida con le penne a inchiostro gel BIC®. Il comfort incontra una superiore maneggevolezza con il grip in gomma, facile da impugnare per il massimo piacere di scrittura.





1062



Iconic BIC® Boy is embossed



40



65

Colour ink  
Encre de couleur  
Color de la tinta  
Schreibfarbe  
Colore inchiostro

**MOQ 250u.**

**Decoration:**

Personnalisation /  
Personalización /  
Dekoration /  
Decorazione

**BIC® ATLANTIS® GEL**

1062

**A PD:** right, left  
or rear clip max 1 col.

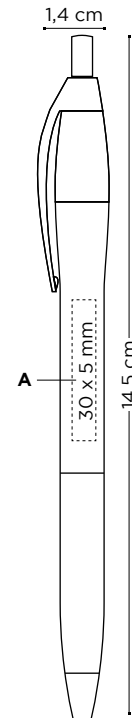

Price (€)

BIC® ATLANTIS® GEL	250-499	500-999	1000-2499	2500-4999	5000-9999	10000-24999	25000-49999
1062							

<b>PD</b>	1,54	1,39	1,29	1,20	1,13	①	①
-----------	------	------	------	------	------	---	---

**Additional imprint charge per position** Frais d'impression supplémentaires pas position / Cargo por impresión adicional por posición / zusätzliche druckkosten pro position / Costo di stampa per posizione addizionale.

<b>PD</b>	0,16	0,13	0,13	0,13	0,12	①	①
-----------	------	------	------	------	------	---	---

**Prices include 1 colour padprint in one position.** Les prix incluent la tampographie monochrome sur un emplacement / El precio incluye un color de impresión tampográfica en una posición / Preise beinhalten einen einfarbigen Tampondruck an einer Position / Il prezzo include la tampografia ad 1 colore in una posizione.

① Price under request. Prix sur demande. Precio bajo consulta. Preis auf Anfrage. Prezzi su richiesta.

**Writing modes:**

Mode écriture /  
Modos de escritura /  
Schreibmodi /  
Modalità di scrittura

Gel



**G**  
Ø0,7mm

until stock lasts.

**Printing techniques:**

Techniques d'impression /  
Técnicas de impresión /  
Drucktechniken /  
Tecniche di stampa



(PD)  
**PAD PRINTING**

**New optional special packaging:**

Nouvel emballage spécial en option /  
Nuevo envasado especial opcional /  
Neue optionale Verpackung /  
Nuove confezioni speciali opzionali



ECO Sleeve / Plastic Pouch / Window Box

+ INFO pag. 306

**External packaging:**

Emballage externe / Envasado exterior / Außenverpackung / Imballaggio esterno



**250 ± 3 Kg**



Opaque - 1136



03

Colour ink  
Encre de couleur  
Color de la tinta  
Schreibfarbe  
Colore inchiostro



05



04



02

Comes in an individual cardboard

Customise it from 500 units **New!**



Erasable ink using thermosensitive technology: write, erase and rewrite repeatedly

FR > L'encre effaçable utilise la technologie thermosensible : écrivez, effacez et réécrivez encore.

ES > Tinta borrable usando una tecnología termosensitiva: Escribe, borra y re-escribe repetidamente

DE > Ausradierbare Tinte dank temperaturempfindlicher Technologie: schreiben, radieren, neu schreiben, immer wieder

IT > Inchiostro cancellabile grazie alla tecnologia termosensibile: scrivi, cancella e riscrivi quante volte vuoi

Available only in:

EU (including Norway, Switzerland and Turkey) Disponible uniquement en: UE (incluant la Norvège, la Suisse et la Turquie) / Solo disponibile en: EU (incluyendo Noruega, Suiza y Turquía) / Verfügbar nur in: EU (inklusive Norwegen, Schweiz und Türkei) / Disponibile solo in: UE (compresa Norvegia, Svizzera e Turchia)



**MOQ 250u.**

**Decoration:**

Personnalisation / Personalización / Dekoration / Decorazione

**BIC® GEL-OCITY® ILLUSION**

1136

**A SP:** max. 1 col.

**B DG:** 4-colour process

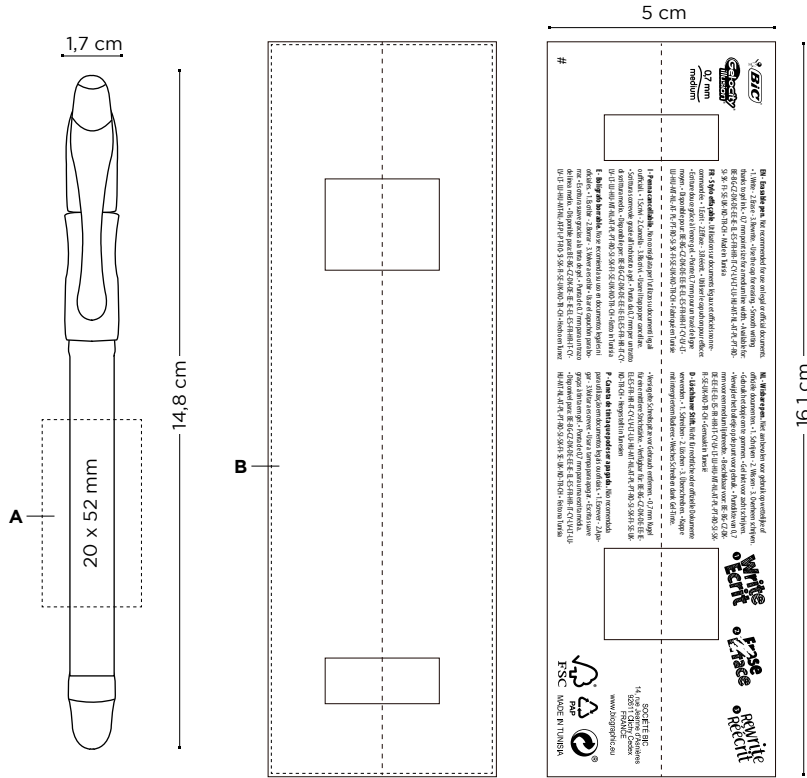

	Price (€)						
<b>BIC® GEL-OCITY® ILLUSION</b>	250-499	500-999	1000-2499	2500-4999	5000-9999	10000-24999	25000-49999
1136							
<b>SP</b>	2,57	2,34	2,18	2,03	1,91	①	①
<b>DG (Cardboard)</b>	-	1,51	1,02	0,81	0,47	0,25	0,22

**Prices include 1 colour screenprint in one position.** Les prix incluent la sérigraphie 1 couleur sur un emplacement / En precio incluye un color en serigrafia en una posición / In den Preisen inbegriffen ist 1 Siebdruck-Farbaufdruck auf 1 Position / I prezzi includono la serigrafia ad 1 colore in una posizione.

**Additional charge for customer logo printed on the cardboard (from 500 u.)** Prix additionnel pour l'impression du logo de votre client sur le carton (à partir de 500 uts) / Cargo adicional por la impresión del logo de su cliente en el cartón (a partir de 500 u.) / Auf dem Karton gedrucktes Kundenlogo gegen Aufpreis (ab 500 Stk.) / Costo addizionale per la personalizzazione del cartoncino (a partire da 500 u.), ① Price under request. Prix sur demande. Precio bajo consulta. Preis auf Anfrage. Prezzi su richiesta.

**Writing modes:**

Mode écriture / Modos de escritura / Schreibmodi / Modalità di scrittura

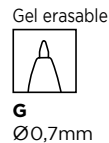

**Printing techniques:**

Techniques d'impression / Técnicas de impresión / Drucktechniken / Tecniche di stampa



**External packaging:**

Emballage externe / Envasado exterior / Außenverpackung / Imballaggio esterno





Opaque - 1196

Clear - 1196

  
 Iconic BIC® Boy  
 is embossed



Colour ink  
 Encre de couleur  
 Color de la tinta  
 Schreibfarbe  
 Colore inchiostro

01

02

92

87

88

86

93



## MOQ 250u.

### Decoration:

Personnalisation / Personalización / Dekoration / Decorazione

### BIC® INTENSITY® GEL CLIC

1196

**A SP:** max. 2 col.

**B SP:** max. 4 col.

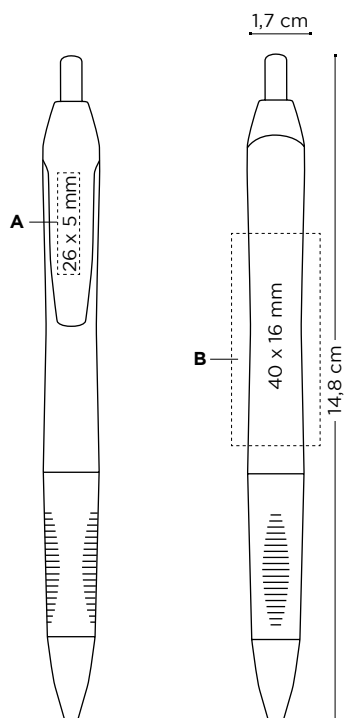

Price (€)

BIC® INTENSITY® GEL CLIC	250-499	500-999	1000-2499	2500-4999	5000-9999	10000-24999	25000-49999
1196							
<b>SP</b>	2,67	2,42	2,24	2,09	1,97	①	①

**Additional imprint charge per colour & position** Frais d'impression supplémentaires par couleur et position / Cargo por impresión adicional por color y posición / Zusätzliche druckkosten pro farbe & position / Costo marchio aggiuntivo per colore e posizione.

<b>SP</b>	0,16	0,13	0,13	0,13	0,12	①	①
-----------	------	------	------	------	------	---	---

**Prices include 1 colour screenprint in one position.** Frais d'impression supplémentaires pas position / Cargo por impresión adicional por posición / In den Preisen ist ein einfarbiger Siebdruck für einen Artikel inkludiert. / I prezzi includono la serigrafia ad 1 colore in una posizione.

① Price under request. Prix sur demande. Precio bajo consulta. Preis auf Anfrage. Prezzi su richiesta.

### Writing modes:

Mode écriture /  
Modos de escritura /  
Schreibmodi /  
Modalità di scrittura

Gel



**G**  
Ø0,7mm

### Printing techniques:

Techniques d'impression /  
Técnicas de impresión /  
Drucktechniken /  
Tecniche di stampa



(SP)  
SCREEN  
PRINTING

### New optional special packaging:

Nouvel emballage spécial en option /  
Nuevo envasado especial opcional /  
Neue optionale Verpackung / Nuove  
confezioni speciali opzionali



Plastic Pouch

+ INFO pag. 306

### External packaging:

Emballage externe / Envasado  
exterior / Außenverpackung /  
Imballaggio esterno



**250** ± 3,7 Kg



Highlight your message with precision and control thanks to the textured rubberised grip.

FR > Donnez de l'impact à votre message par la précision et le contrôle, grâce au grip en caoutchouc.

ES > Resalta tu mensaje con precisión y control gracias al grip de goma.

DE > Markieren Sie Ihre Botschaft präzise und kontrolliert dank der strukturierten, gummierten Griffzone.

IT > Fai risaltare il tuo messaggio con precisione e controllo grazie all'impugnatura in gomma.







*NEW COLOUR!\**  
*NEW COLOUR!\**

1192

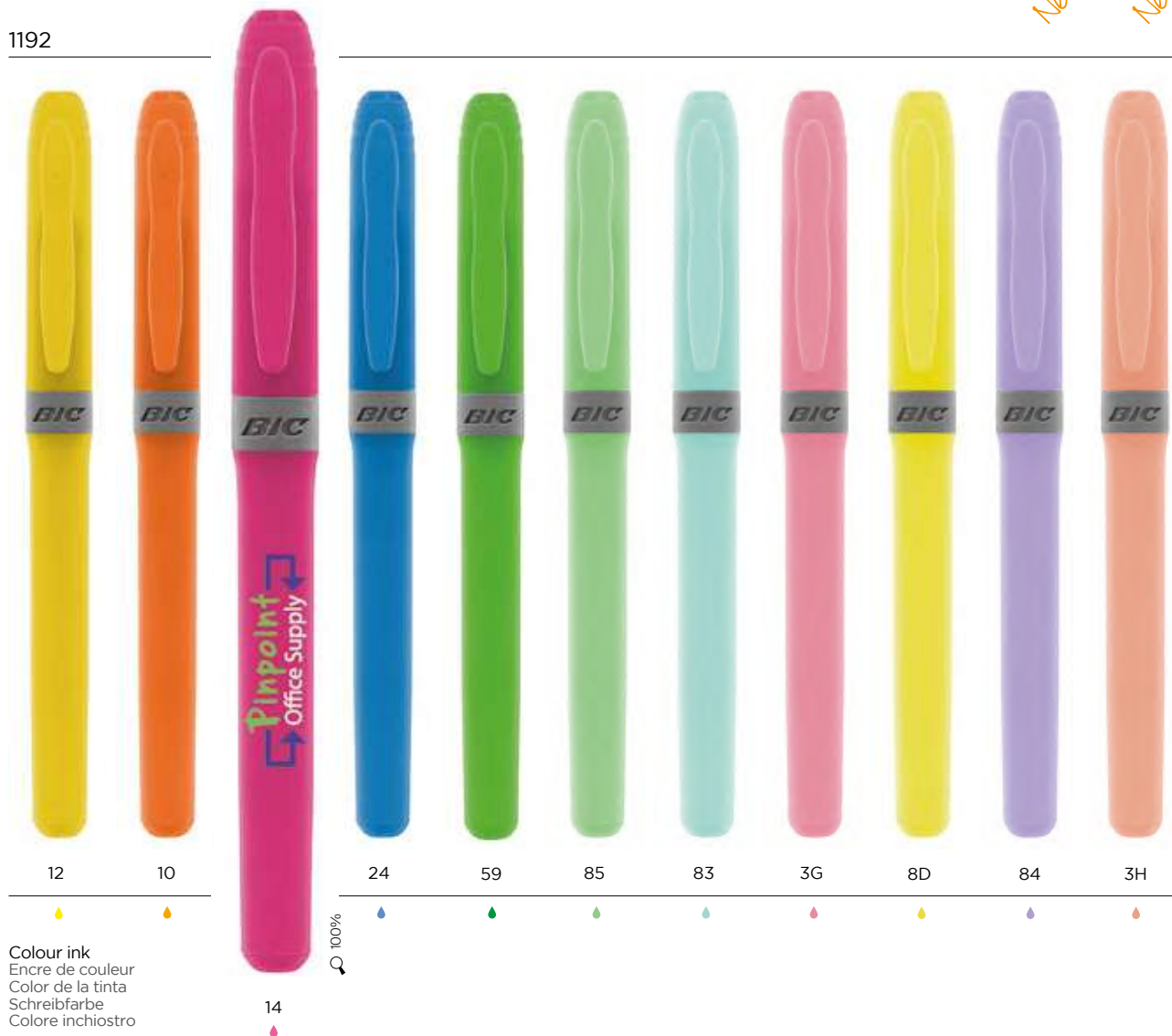

Colour ink  
Encre de couleur  
Color de la tinta  
Schreibfarbe  
Colore inchiostro

14

\*New colours available from April / \*Nouvelles couleurs disponibles en avril / \*Nuevos colores a partir de abril / \*Neue Farben ab April erhältlich / \*Nuovi colori disponibili ad Aprile.

## MOQ 250u.

### Decoration:

Personnalisation / Personalización / Dekoration / Decorazione

### BIC® BRITE LINER® GRIP

1192

A/B SP: max. 3 col.

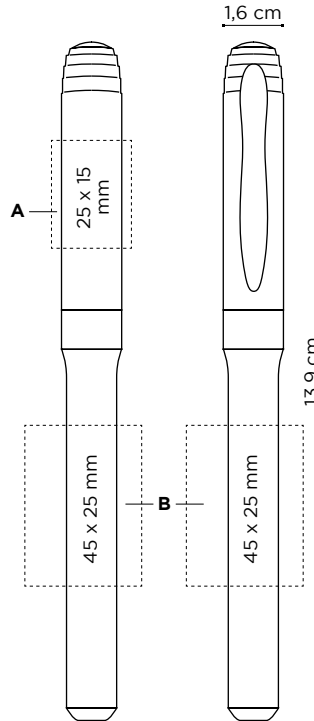

	Price (€)						
<b>BIC® BRITE LINER® GRIP</b>	250-499	500-999	1000-2499	2500-4999	5000-9999	10000-24999	25000-49999
1192							
<b>SP</b>	1,50	1,39	1,27	1,18	1,11	①	①

**Additional imprint charge per colour & position.** Frais d'impression supplémentaires par couleur et position / Cargo por impresión adicional por color y posición / Zusätzliche druckkosten pro farbe & position / Costo marchio aggiuntivo per colore e posizione.

<b>SP</b>	0,16	0,13	0,13	0,13	0,12	①	①
-----------	------	------	------	------	------	---	---

**Prices include 1 colour screenprint in one position.** Les prix incluent la sérigraphie 1 couleur sur un emplacement / En precio incluye un color en serigrafía en una posición / In den Preisen inbegriffen ist 1 Siebdruck-Farbaufdruck auf 1 Position / I prezzi includono la serigrafia ad 1 colore in una posizione.

① Price under request. Prix sur demande / Precio bajo consulta / Preis auf Anfrage / Prezzi su richiesta.

### Writing modes:

Mode écriture / Modos de escritura / Schreibmodi / Modalità di scrittura.

Highlighter



HL

### Printing techniques:

Techniques d'impression / Técnicas de impresión / Drucktechniken / Tecniche di stampa.



(SP)  
SCREEN  
PRINTING

Now you can have it on set!

### New optional special packaging:

Nouvel emballage spécial en option / Nuevo envasado especial opcional / Neue optionale Verpackung / Nuove confezioni speciali opzionali



Marking Set  
+ INFO pag. 307

### External packaging:

Emballage externe / Envasado exterior / Außenverpackung / Imballaggio esterno



250 ± 2,8 Kg





BIC® markers offer you products specifically designed to write in highly visible way and mark on surfaces or material that other writing instruments cannot mark on. Make your ideas visible and express yourself whatever the surface with BIC® Markers.

FR > Les marqueurs BIC® vous proposent des produits spécifiquement conçus pour écrire avec une haute visibilité, et sur des surfaces ou des matériaux sur lesquels d'autres instruments d'écriture ne peuvent être utilisés. Donnez de la visibilité à vos idées et exprimez-vous sur n'importe quelle surface avec les marqueurs BIC®.

DE > BIC®-Textmarker bieten Produkte, die speziell konzipiert wurden, um besonders sichtbar zu schreiben und auf Oberflächen oder Materialien zu markieren, wo anderes Schreibgerät passen muss. Machen Sie Ihre Ideen sichtbar, bringen Sie sie zum Ausdruck, egal auf welcher Fläche, mit BIC® Textmarkern.

ES > BIC® te ofrece productos especialmente diseñados para escribir de una manera altamente visible y marcar superficies o materiales que otros instrumentos de escritura no pueden marcar. Haz tus ideas visibles y expresate a ti mismo en cualquier superficie con los marcadores BIC®.

IT > BIC® offre prodotti specificamente ideati per scrivere in modo particolarmente visibile e lasciare il segno su superfici o materiali su cui altri strumenti di scrittura non funzionano. Esprimiti e dai visibilità alle tue idee su qualsiasi tipo di superficie con i pennarelli BIC®.





1651

MOQ 500u.

**Decoration:**

Personnalisation / Personalización / Dekoration / Decorazione

**BIC® WHITE BOARD MARKER FINE**

1651

A SP: max. 1 col.



0,8 cm

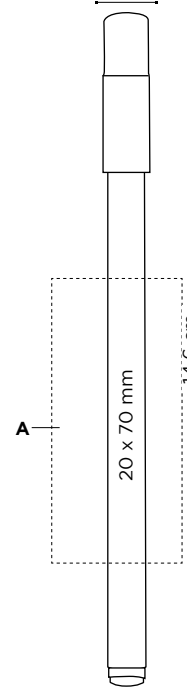

Price (€)

BIC® Velleda® WHITE BOARD MARKER FINE	250-499	500-999	1000-2499	2500-4999	5000-9999	10000-24999	25000-49999
1651							
SP	-	0,54	0,49	0,46	0,43	0,40	0,37

**Prices include 1 colour screenprint in one position.** Les prix incluent la sérigraphie 1 couleur sur un emplacement / En precio incluye un color en serigrafía en una posición / In den Preisen inbegriffen ist 1 Siebdruck-Farbaufdruck auf 1 Position / I prezzi includono la serigrafia ad 1 colore in una posizione. © Price under request. Prix sur demande / Precio bajo consulta / Preis auf Anfrage / Prezzi su richiesta.



01/03

01/04

01/02

01/05



Colour ink  
Encre de couleur  
Color de la tinta  
Schreibfarbe  
Colore inchiostro

**Writing modes:**

Mode écriture / Modos de escritura / Schreibmodi / Modalità di scrittura.

Marker



MK

**Printing techniques:**

Techniques d'impression / Técnicas de impresión / Drucktechniken / Tecniche di stampa.



(SP) SCREEN PRINTING

*Now you can have it on set!*

**New optional special packaging:**

Nouvel emballage spécial en option / Nuevo envasado especial opcional / Neue optionale Verpackung / Nuove confezioni speciali opzionali



Marking Set  
+ INFO pag. 307

**External packaging:**

Emballage externe / Envasado exterior / Außenverpackung / Imballaggio esterno di stampa.



500 ± 3,2 Kg



MADE IN FRANCE





1213



Colour ink  
Encre de couleur  
Color de la tinta  
Schreibfarbe  
Colore inchiostro

01/02



MOQ 250u.

**Decoration:**

Personnalisation / Personalización /  
Dekoration / Decorazione

**BIC® Velleda® WHITE BOARD  
MARKER GRIP**

1213

A/B SP: max. 3 col.

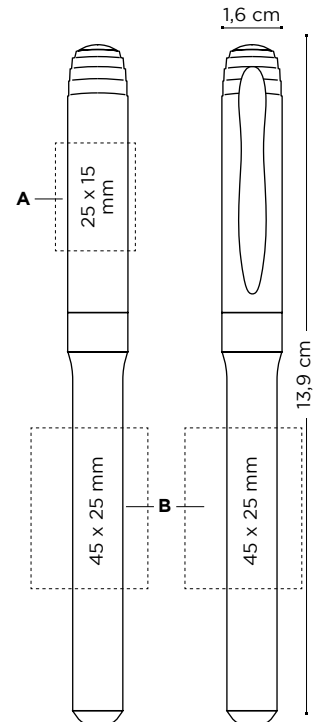

Price (€)

**BIC® Velleda® WHITE BOARD  
MARKER GRIP**

1213

SP	250-499	500-999	1000-2499	2500-4999	5000-9999	10000-24999	25000-49999
	1,48	1,33	1,23	1,15	1,08	①	①

**Additional imprint charge per colour & position** Frais d'impression supplémentaires par couleur et position / Cargo por impresión adicional por color y posición / Zusätzliche druckkosten pro farbe & position / Costo marchio aggiuntivo per colore e posizione.

SP	0,16	0,13	0,13	0,13	0,12	①	①
----	------	------	------	------	------	---	---

**Prices include 1 colour screenprint in one position.** Les prix incluent la sérigraphie 1 couleur sur un emplacement / En precio incluye un color en serigrafía en una posición / In den Preisen inbegriffen ist 1 Siebdruck-Farbaufdruck auf 1 Position / I prezzi includono la serigrafia ad 1 colore in una posizione.

① Price under request. Prix sur demande / Precio bajo consulta / Preis auf Anfrage / Prezzi su richiesta.

Now you can have it on set!

**Writing modes:**

Mode écriture / Modos de escritura / Schreibmodi / Modalità di scrittura.

White board marker



MK

**Printing techniques:**

Techniques d'impression / Técnicas de impresión / Drucktechniken / Tecniche di stampa.



(SP)  
SCREEN  
PRINTING

**New optional special packaging:**

Nouvel emballage spécial en option / Nuevo envasado especial opcional / Neue optionale Verpackung / Nuove confezioni speciali opzionali



Marking Set  
+ INFO pag. 307

**External packaging:**

Emballage externe / Envasado exterior / Außenverpackung / Imballaggio esterno



250 ± 2,7 Kg



1214



01/03

01/05

01/02

01/04

Colour ink  
Encre de couleur  
Color de la tinta  
Schreibfarbe  
Colore inchiostro

100%

**Writing modes:**

Mode écriture / Modos de escritura / Schreibmodi / Modalità di scrittura.

Marker



MK

**Printing techniques:**

Techniques d'impression / Técnicas de impresión / Drucktechniken / Tecniche di stampa.



(SP) SCREEN PRINTING

**MOQ 250u.**

**Decoration:**

Personnalisation / Personalización / Dekoration / Decorazione.

**BIC® MARK-IT PERMANENT MARKER**

1214

A/B SP: max. 3 col.

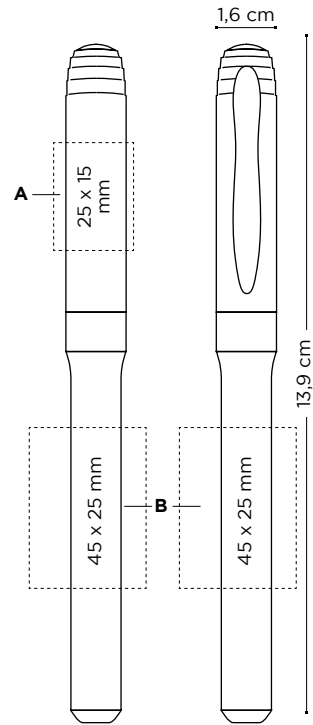

Price (€)

BIC® MARK-IT PERMANENT MARKER 1214	250-499	500-999	1000-2499	2500-4999	5000-9999	10000-24999	25000-49999
SP	1,45	1,30	1,21	1,13	1,06	①	①

**Additional imprint charge per colour & position** Frais d'impression supplémentaires par couleur et position / Cargo por impresión adicional por color y posición / Zusätzliche druckkosten pro farbe & position / Costo marchio aggiuntivo per colore e posizione.

SP	0,16	0,13	0,13	0,13	0,12	①	①
----	------	------	------	------	------	---	---

① Price under request. Prix sur demande / Precio bajo consulta / Preis auf Anfrage / Prezzi su richiesta.

Now you can have it on set!

**New optional special packaging:**

Nouvel emballage spécial en option / Nuevo envasado especial opcional / Neue optionale Verpackung / Nuove confezioni speciali opzionali



Marking Set + INFO pag. 307

**External packaging:**

Emballage externe / Envasado exterior / Außenverpackung / Imballaggio esterno di stampa.



250 ± 2,8 Kg



MADE FROM 51% OF RECYCLED MATERIAL\* & 100% RECYCLABLE



Add the Möbius loop to your artwork at no additional charge. Please specify "Print the Möbius loop" on your order. (Möbius loop imprint defaults to left-hand hand corner.)

1210



O2

O2

Colour ink  
Encre de couleur  
Color de la tinta  
Schreibfarbe  
Colore inchiostro

MOQ 250u.

**Decoration:**

Personalisation / Personalización / Dekoration / Decorazione

**BIC® PERMANENT MARKER **eco**olutions®**

1210

A SP: max. 1 col.

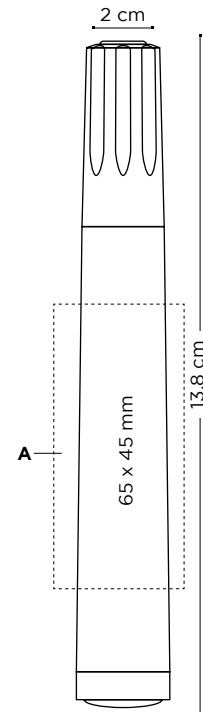

**eco**olutions® Made with 51% recycled material.

Price (€)

BIC® PERMANENT MARKER <b>eco</b> olutions®	250-499	500-999	1000-2499	2500-4999	5000-9999	10000-24999	25000-49999
1210							
SP	1,71	1,56	1,44	1,35	1,26	①	①

Prices include 1 colour screenprint in one position. Les prix incluent la sérigraphie 1 couleur sur un emplacement / En precio incluye un color en serigrafía en una posición / In den Preisen inbegriffen ist 1 Siebdruck-Farbaufdruck auf 1 Position / I prezzi includono la serigrafia ad 1 colore in una posizione.

① Price under request. Prix sur demande / Precio bajo consulta / Preis auf Anfrage / Prezzi su richiesta.

**Writing modes:**

Mode écriture / Modos de escritura / Schreibmodi / Modalità di scrittura.

**Printing techniques:**

Techniques d'impression / Técnicas de impresión / Drucktechniken / Tecniche di stampa.

**External packaging:**

Emballage externe / Envasado exterior / Außenverpackung / Imballaggio esterno

Marker



MK



(SP) SCREEN PRINTING



250 ± 2,6 Kg



MADE IN FRANCE

\*The percentage is calculated on total weight of product excluding ink system / \* Le pourcentage est calculé sur le poids total du produit hors cartouche / \*El porcentaje está calculado sobre el peso total del producto excluyendo el cartucho / \*Der Prozentsatz bezieht sich auf das Gesamtgewicht ohne den Tintenmechanismus / \*la percentuale viene calcolata sul peso totale del prodotto escluso il sistema d'inchiostro



Stay sharp with this first-class mechanical pencil! It is solid and resistant, never needs sharpening and writes smoother and darker than ever!

FR > Toujours prêt avec ce porte-mines de grande qualité. Il est solide et la mine est résistante. Il n'a pas besoin d'être taillé et offre une écriture plus fluide et plus intense que jamais !

DE > Stets schreibbereit mit diesem Qualitäts-Druckbleistift. Solide und resistent, ohne Anspitzen, schreibt dieser Stift leichter und kräftiger denn je!

ES > Siempre preparado con este portaminas de calidad superior. Es sólido y resistente, no necesita afilarse y escribe más fluido e intenso que nunca!

IT > Non perderti questo portamine di prima categoria. Compatto e resistente, non si tempera e scrive più fluido e scuro che mai!





**BIC® MATIC®**  
Opaque - 1120



**BIC® MATIC®**  
**ecolutions®**  
 Opaque - 1E40



MADE FROM 65% OF  
 RECYCLED MATERIAL\*  
 & 100% RECYCLABLE



\*The percentage is calculated on total weight of the product / \*Pourcentage calculé sur le poids total du produit / \*Porcentaje calculado a partir del peso total del producto / \*Der Prozentsatz ist auf der Grundlage des Gesamtgewichts des Produkts berechnet / \*La percentuale é calcolata sul peso totale del prodotto.



Add the Möbius loop to your artwork at no additional charge. Please specify it on your order. (Möbius loop imprint defaults to left-hand corner.)

Ajoutez la boucle Möbius sur votre BAT sans frais additionnel. Merci de le préciser dans votre bon de commande (en bas à gauche par défaut).

Añade el Möbius loop a tu arte final sin cargo adicional. Por favor asegúrate de especificarlo en tu pedido. (La impresión del Möbius loop a mano izquierda en la esquina).

Auf Wunsch können wir ihre Grafik ohne Zusatzkosten mit einer Möbiusband-Prägung versehen. Bitte geben Sie diesen Wunsch bei der Bestellung an. (Die Möbiusband-Prägung wird standardmäßig in der linken Ecke platziert.)

Aggiungi il Mobius loop alla tua grafica senza costi addizionali. Si prega di specificarlo nell'ordine. La stampa del Mobius loop viene fatta di default per destrorsi nell'angolo destro.



**BIC® MATIC® QUARTZ**  
Opaque - 1121



51/01

51/03

51/04



**BIC® MATIC® QUARTZ METALLIC**



51/07

51/18

**BIC® MATIC® GRIP**  
Opaque - 1122



01/04

01/02

**BIC® MATIC® GRIP METALLIC**



02/02

1D/02\*



\*Until stock lasts  
Jusqu'à épuisement  
du stock / Hasta  
que se acaba el  
stock / Solange  
der Vorrat reicht /  
Fino a esaurimento  
scorte.



## MOQ 500u.

### Decoration:

Personnalisation / Personalización / Dekoration / Decorazione.

#### BIC® MATIC®

1120

@C@lutions® 1E40

#### BIC® MATIC®

#### QUARTZ & METALLIC

1121

**A SP:** max. 1 col. (not available for BIC® Matic® Quartz)

**B/C SP:** max. 2 col.

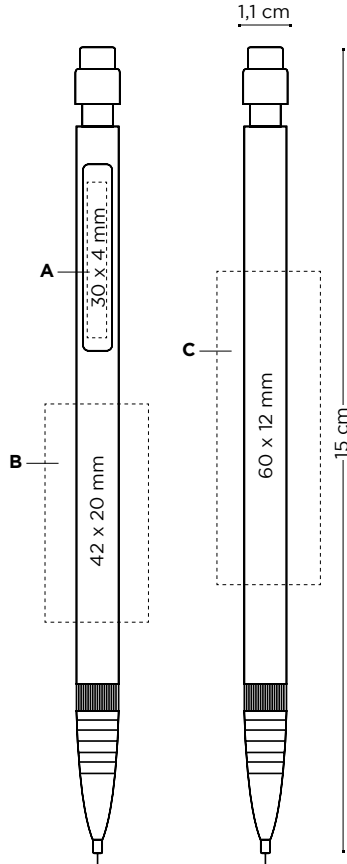

Price (€)

@C@lutions® version & STD at the same price!



BIC® MATIC® QUARTZ & METALLIC 1120/@C@lutions® 1E40	500-999	1000-2499	2500-4999	5000-9999	10000-24999	25000-49999
SP	0,76	0,71	0,66	0,62	0,58	0,54

1121						
SP	0,83	0,76	0,71	0,67	0,63	0,59

**Additional imprint charge per colour & position.** Frais d'impression supplémentaires par couleur et position / Cargo por impresión adicional por color y posición / Zusätzliche druckkosten pro farbe & position / Costo marchio aggiuntivo per colore e posizione.

SP	0,13	0,13	0,13	0,12	0,11	0,11
----	------	------	------	------	------	------

**Prices include 1 colour screenprint in one position.** Les prix incluent la sérigraphie 1 couleur sur un emplacement / En precio incluye un color en serigrafía en una posición / In den Preisen inbegriffen ist 1 Siebdruck-Farbaufdruck auf 1 Position / I prezzi includono la serigrafia ad 1 colore in una posizione.

### Writing modes:

Mode écriture / Modos de escritura / Schreibmodi / Modalità di scrittura.

Mechanical pencil



**MP**  
Ø0,7mm

### Printing techniques:

Techniques d'impression / Técnicas de impresión / Drucktechniken / Tecniche di stampa.



(SP)  
SCREEN PRINTING

### New optional special packaging:

Nouvel emballage spécial en option / Nuevo envasado especial opcional / Neue optionale Verpackung / Nuove confezioni speciali opzionali



ECO Sleeve / Plastic Pouch  
+ INFO pag. 306

### External packaging:

Emballage externe / Envasado exterior / Außenverpackung / Imballaggio esterno.



500 ± 3,1 Kg



MADE IN FRANCE

#### BIC® MATIC® GRIP & METALLIC

1122

**A SP:** max. 1 col.

**B/C SP:** max. 2 col.

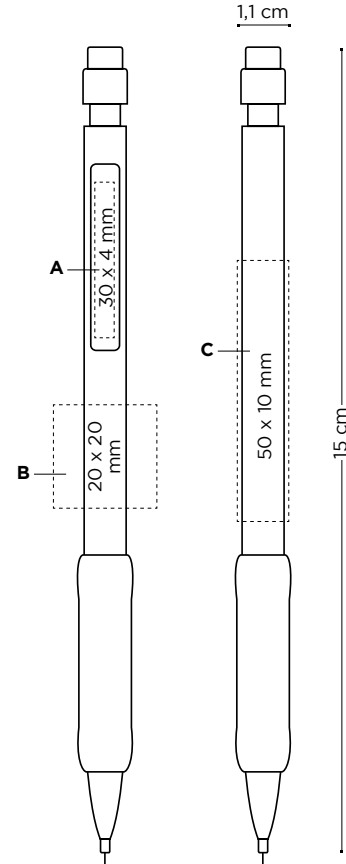

Price (€)

BIC® MATIC® GRIP & METALLIC 1122	500-999	1000-2499	2500-4999	5000-9999	10000-24999	25000-49999
SP	0,91	0,85	0,80	0,74	0,69	0,64

**Additional imprint charge per colour & position.** Frais d'impression supplémentaires par couleur et position / Cargo por impresión adicional por color y posición / Zusätzliche druckkosten pro farbe & position / Costo marchio aggiuntivo per colore e posizione.

SP	0,13	0,13	0,13	0,12	0,11	0,11
----	------	------	------	------	------	------

**Prices include 1 colour screenprint in one position.** Les prix incluent la sérigraphie 1 couleur sur un emplacement / En precio incluye un color en serigrafía en una posición / In den Preisen inbegriffen ist 1 Siebdruck-Farbaufdruck auf 1 Position / I prezzi includono la serigrafia ad 1 colore in una posizione.

Wood-free pencil made with recycled synthetic resin material, that will not splinter in the event of breaking. Ultra-resistant HB graphite lead and excellent erasability!

FR > Crayon papier en résine synthétique, sans bois, qui ne fait pas d'écharde en cas de casse. Mine graphite HB ultra-résistante qui s'efface rapidement !

DE > Holzfreier Bleistift aus recyceltem Kunstharzmaterial, das nicht splittert, wenn es bricht. Extrem robuste HB-Graphitmine! Lässt sich hervorragend ausradieren!

ES > Lápiz de grafito de resina sintética, sin madera, hecho con un material reciclado, que no se astilla en caso de rotura. Resistente mina de grafito HB y excelente calidad de borrado!

IT > Matita senza legno realizzata in resina sintetica riciclata che non produce schegge in caso di rottura. Mina HB in grafite ultrasensibile ed eccellente cancellabilità!





1150  
MADE FROM 54% OF RECYCLED MATERIAL\* & 100% RECYCLABLE



1151  
MADE FROM 46% OF RECYCLED MATERIAL\* & 100% RECYCLABLE



Graphite Pencil Cut End  
1150

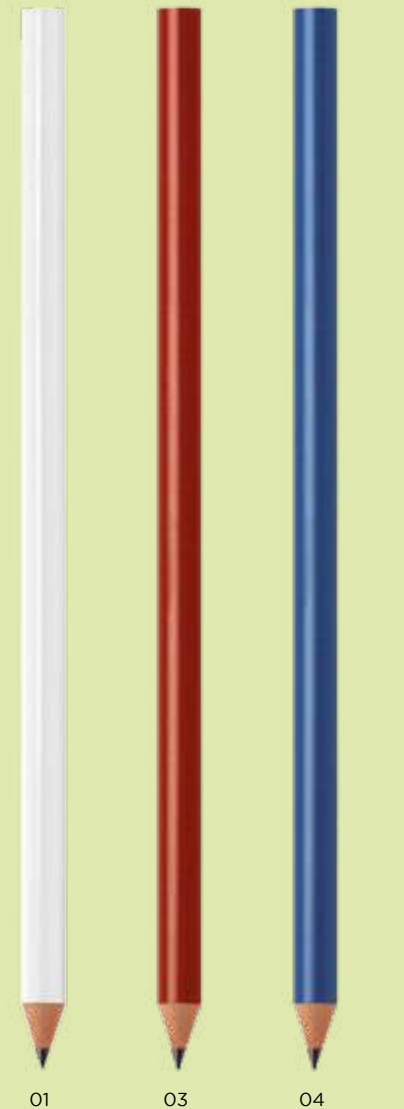

01

03

04

20



Graphite Pencil With Eraser  
1151



02

01

03

04

20



\*The percentage is calculated on total weight of the product / \*Pourcentage calculé sur le poids total du produit / \*Porcentaje calculado a partir del peso total del producto / \*Der Prozentsatz ist auf der Grundlage des Gesamtgewichts des Produkts berechnet / \*La percentuale é calcolata sul peso totale del prodotto.

## Digital Printing!



1150

MADE FROM 54% OF RECYCLED MATERIAL\* & 100% RECYCLABLE

**DIGITAL**

Graphite pencil cut end - 1150



01



1151

MADE FROM 46% OF RECYCLED MATERIAL\* & 100% RECYCLABLE

**DIGITAL**

Graphic pencil with eraser - 1151

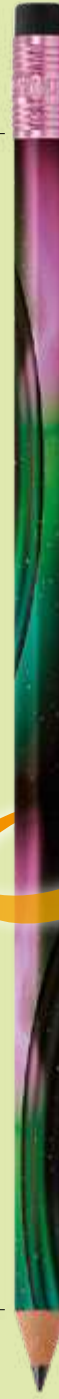

01



**METALLIC DIGITAL**

Graphite pencil cut end - 1962



47



**METALLIC DIGITAL**

Graphic pencil with eraser - 1960



47



\*The percentage is calculated on total weight of the product / \*Pourcentage calculé sur le poids total du produit / \*Porcentaje calculado a partir del peso total del producto / \*Der Prozentsatz ist auf der Grundlage des Gesamtgewichts des Produkts berechnet / \*La percentuale é calcolata sul peso totale del prodotto.

## MOQ 500u.

**MIX & MATCH**



### Standard colours combination

Combinaison de couleurs standards / Combinación de colores estandar / Standardfarbkombination / Combinazione colori standard.

#### Eraser

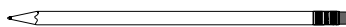

OPAQUE 01 COLOUR CONNECTION 01 12 10 14 59 07 02

#### Ferrule

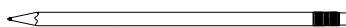

OPAQUE 47 26 2C 34 02

#### Barrel



OPAQUE 01 03 04 20 02

#### Metallic



OPAQUE 47 26

GRAPHITE PENCIL CUT END:



Add the Möbius loop to your artwork at no additional charge. Please specify it on your order. (Möbius loop imprint defaults to left-hand hand corner.)

Ajoutez la boucle Möbius sur votre BAT sans frais additionnel. Merci de le préciser dans votre bon de commande (en bas à gauche par défaut).

Añade el Möbius loop a tu arte final sin cargo adicional. Por favor asegúrate de especificarlo en tu pedido. (La impresión del Möbius loop a mano izquierda en la esquina).

Auf Wunsch können wir ihre Grafik ohne Zusatzkosten mit einer Möbiusband-Prägung versehen. Bitte geben Sie diesen Wunsch bei der Bestellung an. (Die Möbiusband-Prägung wird standardmäßig in der linken Ecke platziert.)

Aggiungi il Mobius loop alla tua grafica senza costi addizionali. Si prega di specificarlo nell'ordine. La stampa del Mobius loop viene fatta di default per destrorsi nell'angolo destro.

**MADE FROM 54% OF RECYCLED MATERIAL\* & 100% RECYCLABLE**

#### Writing modes:

Mode écriture / Modos de escritura / Schreibmodi / Modalità di scrittura.



**PC**  
HB Ø 2,3mm

#### Printing techniques:

Techniques d'impression / Técnicas de impresión / Drucktechniken / Tecniche di stampa.



(SP)  
SCREEN  
PRINTING



(DG)  
DIGITAL

#### New optional special packaging:

Nouvel emballage spécial en option / Nuevo envasado especial opcional / Neue optionale Verpackung / Nuove confezioni speciali opzionali



Plastic Pouch  
(x3 units)  
+ INFO pag. 306

#### External packaging:

Emballage externe / Envasado exterior / Außenverpackung / Imballaggio esterno.



**500 ± 3,5 Kg**



**MADE IN FRANCE**

**BIC<sup>®</sup> EVOLUTION<sup>®</sup> eCOlutions<sup>®</sup>**  
 PENCIL WITH CUT END  
 1150

**BIC<sup>®</sup> EVOLUTION<sup>®</sup> eCOlutions<sup>®</sup>**  
 PENCIL WITH ERASER  
 1151

**A SP:** max. 2 col.  
**B SP:** max. 1 col.

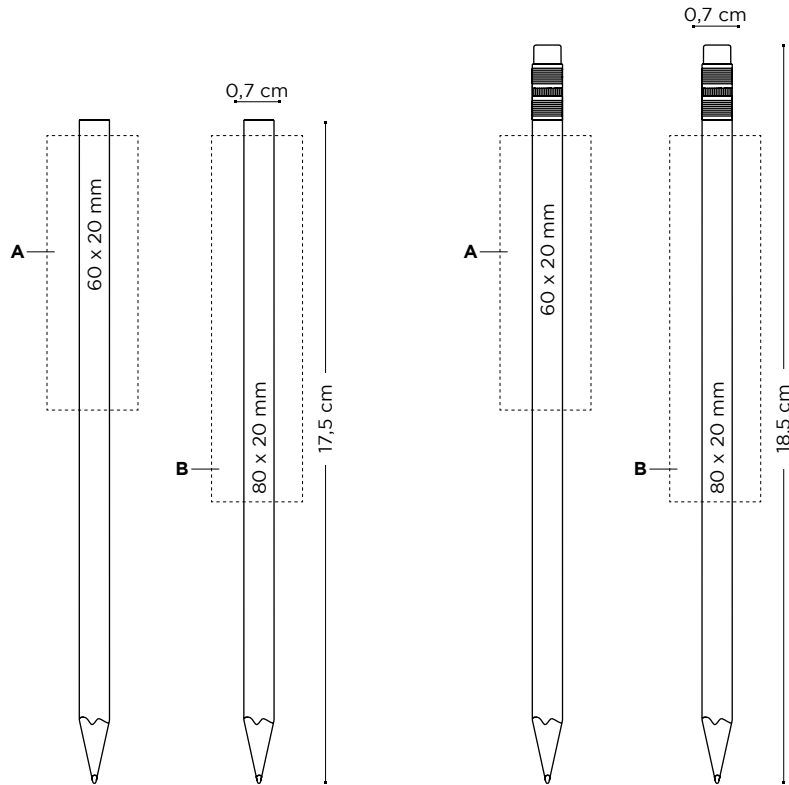

Price (€)

BIC <sup>®</sup> EVOLUTION <sup>®</sup> eCOlutions <sup>®</sup>	500-999	1000-2499	2500-4999	5000-9999	10000-24999	25000-49999
PENCIL WITH CUT END / 1150						
<b>SP</b>	0,44	0,42	0,39	0,37	0,35	0,33
PENCIL WITH ERASER / 1151						
<b>SP</b>	0,74	0,69	0,65	0,61	0,57	0,53

**Additional imprint charge per colour & position.** Frais d'impression supplémentaires par couleur et position / Cargo por impresión adicional por color y posición / Zusätzliche druckkosten pro farbe & position / Costo marchio aggiuntivo per colore e posizione.

<b>SP</b>	0,13	0,13	0,13	0,12	0,11	0,11
-----------	------	------	------	------	------	------

**Prices include 1 colour screenprint in one position.** Les prix incluent la sérigraphie 1 couleur sur un emplacement / En precio incluye un color en serigrafía en una posición / In den Preisen inbegriffen ist 1 Siebdruck-Farbaufdruck auf 1 Position / I prezzi includono la serigrafia ad 1 colore in una posizione.

**External packaging:**

Emballage externe / Envasado exterior / Außenverpackung / Imballaggio esterno.



500 ± 3,5 Kg



MADE IN FRANCE

**BIC® EVOLUTION® eColutions®**

PENCIL WITH CUT END

1150 Digital

1962 Metallic Digital

**BIC® EVOLUTION® eColutions®**

PENCIL WITH ERASER DIGITAL

1151

PENCIL WITH ERASER

METALLIC DIGITAL

1960

**A DG:** full-colour (area for images)

**B DG:** full-colour (area for text)

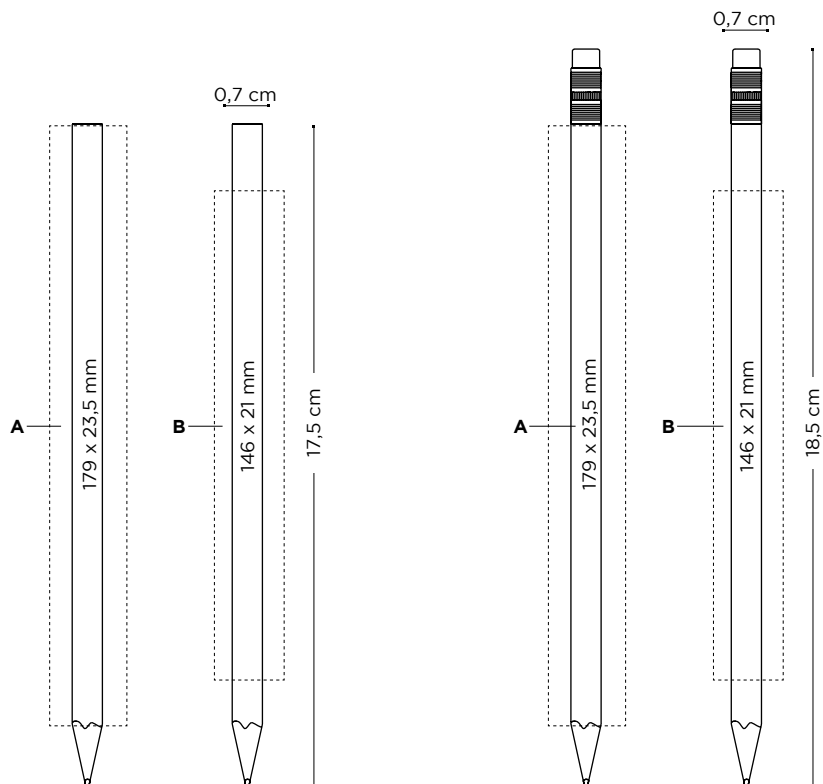

Price (€)

BIC® EVOLUTION® eColutions®	500-999	1000-2499	2500-4999	5000-9999	10000-24999	25000-49999
PENCIL WITH CUT END DIGITAL / 1150						
<b>DG</b>	0,68	0,65	0,60	0,56	①	①
PENCIL WITH CUT END METALLIC / 1962						
<b>DG</b>	0,82	0,77	0,70	0,65	①	①
PENCIL WITH ERASER DIGITAL / 1151						
<b>DG</b>	0,99	0,93	0,87	0,81	①	①
PENCIL WITH ERASER METALLIC DIGITAL / 1960						
<b>DG</b>	1,12	1,05	0,98	0,91	①	①

**Prices include digital imprint on barrel.** Les prix incluent l'impression numérique sur le corps / El precio incluye impresión digital en el cuerpo / Preise beinhalten Digitaldruck auf dem Schaft / I prezzi comprendono la stampa digitale sul fusto.

① Price under request. Prix sur demande / Precio bajo consulta / Preis auf Anfrage / Prezzi su richiesta.

Now you can have it on set!

**New optional special packaging:**

Nouvel emballage spécial en option / Nuevo envasado especial opcional / Neue optionale Verpackung / Nuove confezioni speciali opzionali



Plastic Pouch  
(x3 units)  
+ INFO pag. 306

**External packaging:**

Emballage externe / Envasado exterior / Außenverpackung / Imballaggio esterno.



500 ± 3,5 Kg

1150  
1151  
1960



500 ± 2,6 Kg

1962



MADE IN FRANCE

The logo for Sprout, featuring the word "Sprout" in a green, cursive font with a small leaf icon at the end.

Customized Sprout pencils are used by companies and organisations all over the world to spread their sustainability message. Once the pencil is too short to write with, plant the stub and watch your message turn into a pot of beautiful herbs, flowers or vegetables.

FR > Les crayons Sprout personnalisables sont utilisés par les entreprises et les organisations du monde entier pour communiquer leur respect de l'environnement. Une fois que le crayon est trop court pour écrire, plantez-le et regardez votre message se transformer en superbe pot d'herbes aromatiques, de fleurs ou de légumes.

DE > Die kundenspezifisch anpassbaren Sprout-Bleistifte werden von Unternehmen und Organisationen weltweit genutzt, um ihre Nachhaltigkeitsbotschaft zu übermitteln. Wenn der Stift zum Schreiben zu kurz geworden ist, pflanzen Sie den Stummel ein und sehen Sie, wie Ihre Botschaft zu einem Topf schöner Kräuter, Blumen oder Gemüse wird.

ES > Los lápices Sprout personalizables son usados por la compañías y organizaciones en todo el mundo para difundir su mensaje de sostenibilidad. Una vez que el lápiz es demasiado corto para escribir, plántalo por la parte de arriba y mira como tu mensaje se convierte en una maceta de hermosas hierbas, flores o vegetales.

IT > Le matite personalizzate Sprout sono utilizzate da società e organizzazioni di tutto il mondo per diffondere il proprio messaggio di sostenibilità. Quando la matita diventa troppo corta per scrivere, si può piantare trasformando il proprio messaggio in un bellissimo vaso di erbe aromatiche, fiori o verdure.





*Combine options!*

1. Choose between 10 different seeds
2. Customize your pencil
3. Add a card with planting instructions

FR> Combinez ces options! 1. Choisissez entre les graines différentes 2. Personnalisez votre crayon 3. Ajoutez le carton avec le mode d'emploi  
 ES> Combina opciones! 1. Escoge entre 10 semillas diferentes. 2. Personaliza tu lápiz 3. Añade una tarjeta con las instrucciones para plantar.  
 DE> 1. Wählen Sie aus zehn verschiedenen Samensorten 2. Personalisieren Sie Ihren Bleistift 3. Fügen Sie eine Karte mit einer Pflanzanleitung hinzu  
 IT> Combina le opzioni! 1. Scegli tra 10 semi differenti 2. Personalizza la tua matita 3. Aggiungi il cartoncino con le istruzioni per piantare

standard cardboard

customizable cardboard

53062



Standard barrel

Customized barrel



Standard cardboard packaging  
 Emballage non personnalisable / Cartón no personalizable / Pappe kann nicht angepasst werden / Cartone non personalizzabile.



back



Personalised cardboard packaging  
 Emballage personnalisable ! / Cartón personalizable / Pappe kann an Kundenwünsche angepasst werden! / Cartone personalizzabile!

# Sprouta MULTI COLOURED PENCIL



New!

1 plantable pencil - 4 colours!

1. Choose between 10 different seeds
2. Customize your pencil
3. Add a card with planting instructions

FR> Combinez ces options! 1. Choisissez entre les graines différentes 2. Personnalisez votre crayon 3. Ajoutez le carton avec le mode d'emploi  
 ES> Combina opciones! 1. Escoge entre 10 semillas diferentes. 2. Personaliza tu lápiz 3. Añade una tarjeta con las instrucciones para plantar.  
 DE> 1. Wählen Sie aus zehn verschiedenen Samensorten 2. Personalisieren Sie Ihren Bleistift 3. Fügen Sie eine Karte mit einer Pflanzanleitung hinzu  
 IT> Combina le opzioni! 1. Scegli tra 10 semi differenti 2. Personalizza la tua matita 3. Aggiungi il cartoncino con le istruzioni per piantare

standard cardboard

customizable cardboard

53070



Standard barrel

Customized barrel

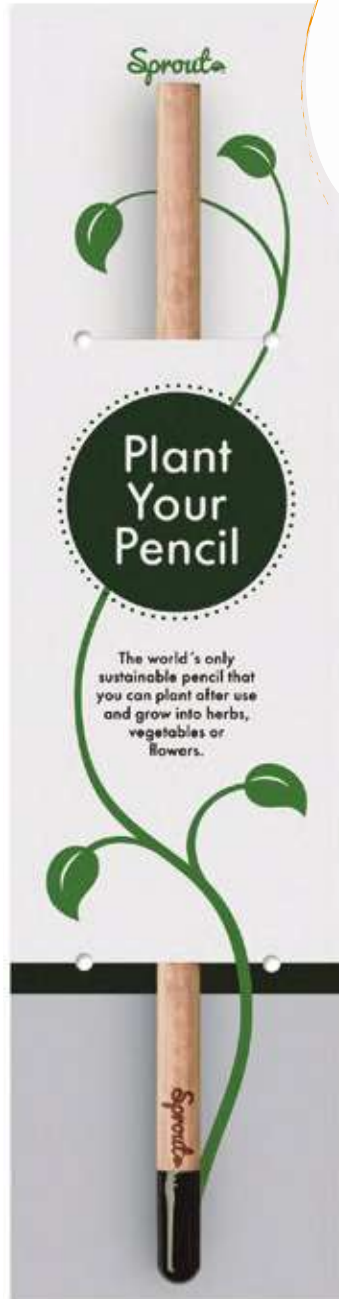

Standard cardboard packaging  
 Emballage non personnalisable / Cartón no personalizable / Pappe kann nicht angepasst werden / Cartone non personalizzabile.



back



Personalised cardboard packaging  
 Emballage personnalisable ! / Cartón personalizable / Pappe kann an Kundenwünsche angepasst werden! / Cartone personalizzabile!

80%



**MOQ 500**  
**MOQ 1000** (Pencil + personalised cardboard packaging)

**Decoration:**

Personalisation / Personalización / Dekoration / Decorazione.

**SPROUT™ PENCIL**

53062 / 53070

**A LE**

**B DG:** 4-colour process

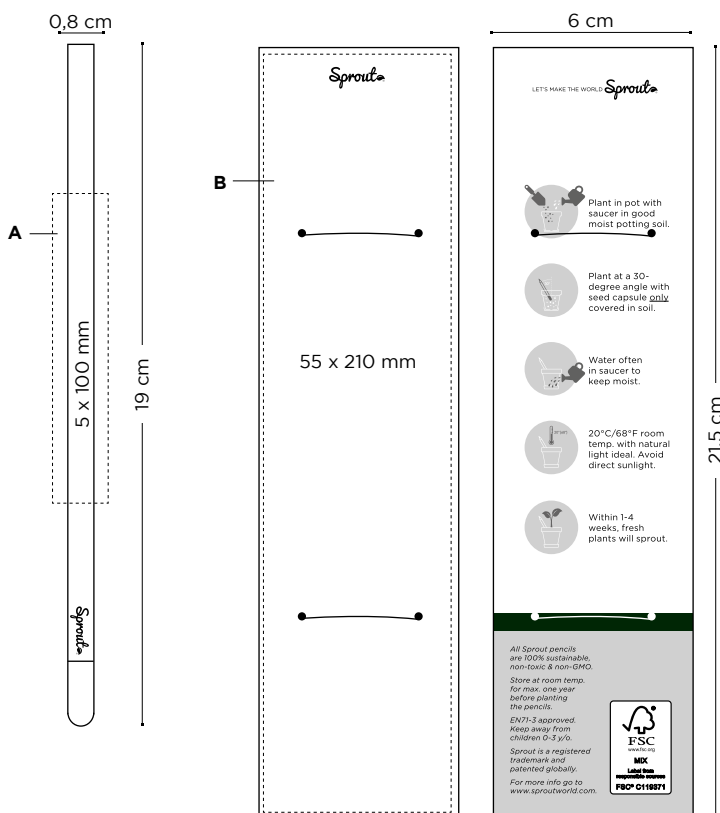

Plant instructions included on the back side. For customized cardboard, you can change the font and colours!

Mode d'emploi inclus au dos Pour un carton personnalisé, vous pouvez changer la police et les couleurs

Instrucciones para plantar incluidas en el parte de atrás. Para personalizar el cartón, se pueden cambiar la fuente y los colores!

Mit Pflanzanleitung auf der Rückseite. Schriftart und Farben sind beim individuell gestaltbaren Karton anpassbar!

Istruzioni per piantare incluse sul retro. Possibilità di personalizzare il cartoncino cambiando caratteri e colori!

**Writing modes:**

Mode écriture / Modos de escritura / Schreibmodi / Modalità di scrittura.



**PC**  
HB Ø 2,3mm

**Printing techniques:**

Techniques d'impression / Técnicas de impresión / Drucktechniken / Tecniche di stampa.



(DG)  
DIGITAL



(LE)  
LASER

**External packaging:**

Emballage externe / Envasado exterior / Außenverpackung / Imballaggio esterno.



**500** ± 2,5 Kg Only pencil  
± 5 Kg with cardboard packaging

**Packaging:**

Emballage / Envasado / Verpackung / Imballaggio.



**Check out the video**

Regardez la video / Mira el video / Produktvideo / Guarda il video.

Set of 6 colouring pens with bright colours supported by the recognised BIC® brands PLASTIDECOR® and EVOLUTION®. Presented in a fully customized carton wallet, this is an ideal promotional item for children and teenagers!

FR > Set de 6 crayons aux couleurs vives sous les célèbres marques BIC® : PLASTIDECOR® et EVOLUTION®. Présenté dans une pochette carton totalement personnalisée. Un article de promotion idéal pour les enfants et les ados !

DE > Set aus 6 Buntstiften mit leuchtenden Farben der bekannten BIC®-Marken: PLASTIDECOR® und EVOLUTION®. Präsentiert in einem ganz den Kundenwünschen angepassten Etui aus Karton. Ein idealer Werbeartikel für Kinder und Jugendliche!

ES > Set de 6 lápices con colore brillantes bajo el soporte de las reconocidas marcas BIC®: PLASTIDECOR® y EVOLUTION®. Presentado en una funda de carton totalmente personalizable, ésta es una idea de producto promocional tanto para niños como adolescentes!

IT > Set di 6 pastelli in vivaci colori con i famosissimi marchi BIC®: PLASTIDECOR® e EVOLUTION®. Presentato in un astuccio di cartone personalizzato, è l'articolo promozionale ideale per bambini e teenager!







Colouring crayons 1201



100%

MOQ 500u.

**Decoration:**

Personnalisation / Personalización / Dekoration / Decorazione.

**BIC® PLASTIDECOR®  
SET OF 6 CRAYONS**

1201

A DG: 4-colour process

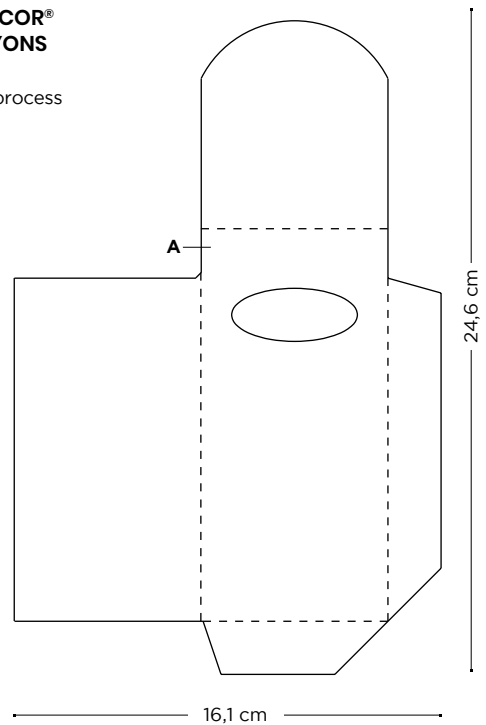

Price (€)

BIC® PLASTIDECOR® SET OF 6 CRAYONS	500-999	1000-2499	2500-4999	5000-9999	10000-24999	25000-49999
1201						
DG	3,17	2,39	1,96	1,71	①	①

**All BIC® Colouring pens include 4-colour process printing on the carton wallet.**  
 Toute la gamme BIC® Colouring inclut l'impression en quadrichromie sur la pochette en carton / Toda la gama de BIC® Colouring incluye impresión en cuatricromia en el funda de cartón / Bei allen BIC® Colouring Malstiften ist Vierfarbdruck auf dem Kartonetui inbegriffen / Tutti i pennarelli per colorare BIC® comprendono il processo di stampa a 4 colori sulla custodia in cartone.  
 ① Price under request. Prix sur demande / Precio bajo consulta / Preis auf Anfrage / Prezzi su richiesta.

**Writing modes:**

Mode écriture / Modos de escritura / Schreibmodi / Modalità di scrittura.



**Printing techniques:**

Techniques d'impression / Técnicas de impresión / Drucktechniken / Tecniche di stampa.



(DG)  
DIGITAL

**External packaging:**

Emballage externe / Envasado exterior / Außenverpackung / Imballaggio esterno.



84 ± 3,8 Kg

Colouring pencils 1202



\*Made with 50% recycled material.

80%

Easy to sharpen!



MOQ 500u.

**Decoration:**

Personnalisation / Personalización / Dekoration / Decorazione.

**BIC® EVOLUTION® ECOLUTIONS® SET OF 6 COLOURING PENCILS**

1202

A DG: 4-colour process

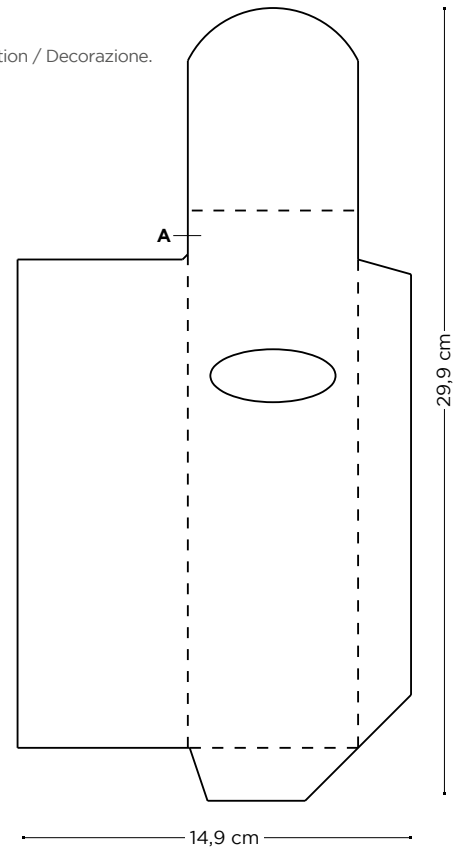

Price (€)

**BIC® EVOLUTION® ECOLUTIONS® SET OF 6 COLOURING PENCILS**

1202

DG

	500-999	1000-2499	2500-4999	5000-9999	10000-24999	25000-49999
Price (€)	3,33	2,51	2,06	1,80	①	①

All BIC® Colouring pens include 4-colour process printing on the carton wallet. Toute la gamme BIC® Colouring inclut l'impression en quadrichromie sur la pochette en carton / Toda la gama de BIC® Colouring incluye impresión en cuatricromia en el funda de cartón / Bei allen BIC® Colouring Malstiften ist Vierfarbdruck auf dem Kartonetui inbegriffen / Tutti i pennarelli per colorare BIC® comprendono il processo di stampa a 4 colori sulla custodia in cartone.

① Price under request. Prix sur demande / Precio bajo consulta / Preis auf Anfrage / Prezzi su richiesta.

**Writing modes:**

Mode écriture / Modos de escritura / Schreibmodi / Modalità di scrittura.



**Printing techniques:**

Techniques d'impression / Técnicas de impresión / Drucktechniken / Tecniche di stampa.



(DG) DIGITAL

**External packaging:**

Emballage externe / Envasado exterior / Außenverpackung / Imballaggio esterno.



60 ± 2,6 Kg



MADE IN FRANCE



# SET OF 6 COLOURING PENCILS



Strong lead



Vibrant Colours



## Colouring pencils 1178



wood free pencils

MOQ 500u.

### Decoration:

Personnalisation / Personalización / Dekoration / Decorazione.

### CONTÉ® SET OF 6 COLOURING PENCILS

1178

A DG: 4-colour process

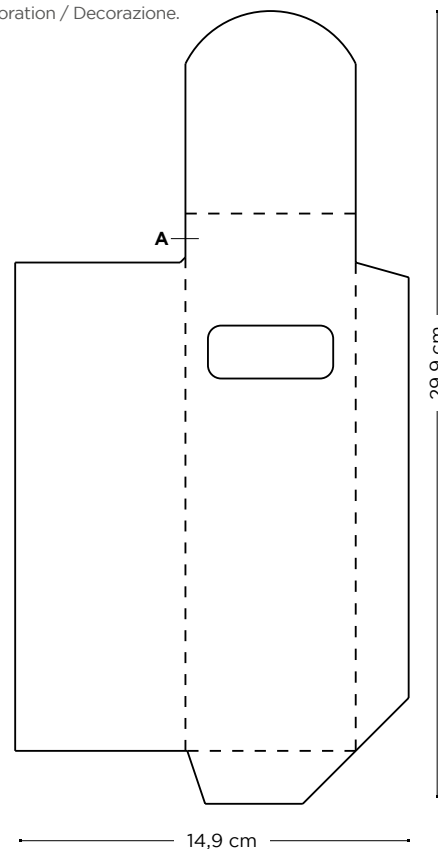

Price (€)

### CONTÉ® SET OF 6 COLOURING PENCILS

1178

DG

500-999	1000-2499	2500-4999	5000-9999	10000-24999	25000-49999
3,70	2,87	2,46	2,11	①	①

### All BIC® Colouring pens include 4-colour process printing on the carton wallet.

Toute la gamme BIC® Colouring inclut l'impression en quadrichromie sur la pochette en carton / Toda la gama de BIC® Colouring incluye impresión en cuatricromia en el funda de cartón / Bei allen BIC® Colouring Malstiften ist Vierfarbdruck auf dem Kartonetui inbegriffen / Tutti i pennarelli per colorare BIC® comprendono il processo di stampa a 4 colori sulla custodia in cartone.

① Price under request. Prix sur demande / Precio bajo consulta / Preis auf Anfrage / Prezzi su richiesta.

### Writing modes:

Mode écriture / Modos de escritura / Schreibmodi / Modalità di scrittura.



### Printing techniques:

Techniques d'impression / Técnicas de impresión / Drucktechniken / Tecniche di stampa.



(DG) DIGITAL

### External packaging:

Emballage externe / Envasado exterior / Außenverpackung / Imballaggio esterno.



60 ± 2,2 Kg



MADE IN FRANCE



create your own combination

**BIC PLASTIDECOR** SET OF 6 CRAYONS or **BIC EVOLUTION** **ecolutions** SET OF 6 COLOURING PENCILS



**Writing modes:**

Mode écriture / Modos de escritura / Schreibmodi / Modalità di scrittura.



**Packaging:**

Emballage / Envasado / Verpackung / Imballaggio.

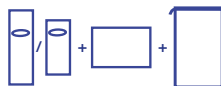

**Printing techniques:**

Techniques d'impression / Técnicas de impresión / Drucktechniken / Tecniche di stampa.



(SP)  
SCREEN  
PRINTING



(OT)  
OFFSET  
TRANSFER

MOQ 500u.

**Decoration:**

Personalisation / Personalización / Dekoration / Decorazione.

**BIC® PLASTIDECOR®  
COLOURING SET  
1294**



**BOX  
C DG: 4-colour process**

**BAG**

No imprint (bag)  
**A SP** (bag): max 2 col.  
**B OT** (bag): full-colour

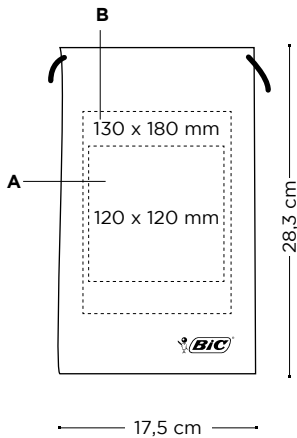

**BOOK  
C DG: 4-colour process**

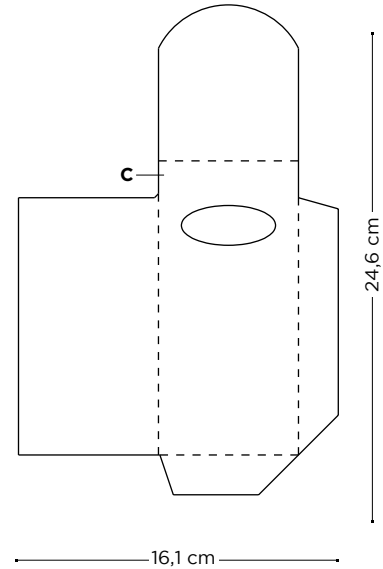
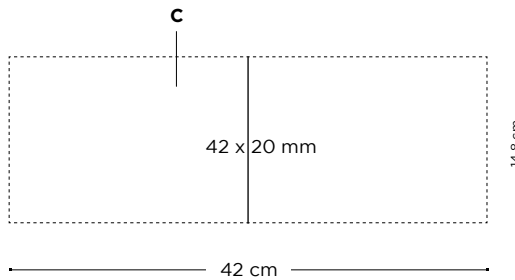

Price (€)

BIC® PLASTIDECOR® COLOURING SET 1294	500-999	1000-2499	2500-4999	5000-9999	10000-24999	25000-49999
No imprint (bag)	9,82	7,07	5,65	4,74	①	①
SP (bag)	10,69	7,79	6,31	5,39	①	①
OT (bag)	11,62	8,69	7,20	6,28	①	①

**Additional imprint charge per colour & position.** Frais d'impression supplémentaires par couleur et position / Cargo por impresión adicional por color y posición / Zusätzliche druckkosten pro farbe & position / Costo marchio aggiuntivo per colore e posizione.

<b>SP</b>	0,87	0,72	0,66	0,65	①	①
<b>OT</b>	1,80	1,62	1,55	1,54	①	①

**BIC® Colouring Pens sets are made up of a personalised box, a coloring book and a cotton drawstring bag with BIC® logo. Prices include full colour personalisation on the box and the coloring book. Imprint on the bag is optional. Prices above vary according to the personalisation technique chosen for the bag.** Les sets de coloriage BIC® Colouring sont composés d'une boîte de crayons de couleur, d'un cahier de coloriage et d'un sac en coton à cordon coulissant portant le logo BIC®. Le prix inclut la personnalisation complète de la boîte à crayons et du cahier de coloriage. L'impression sur le sac est en option. Les prix ci-dessus varient en fonction de la technique de personnalisation choisie pour le sac / Los sets BIC® Colouring Pens están compuestos por una caja personalizada, un libro para colorear y una bolsa de algodón con el logo BIC®, Los precios incluyen la personalización a todo color en la caja y en el libro para colorear. La impresión en la bolsa es opcional. Los precios anteriores varían según la técnica de personalización elegida para la bolsa / BIC® Mal-Sets bestehen aus einer Schachtel, einem Malbuch und einem Kordelzugbeutel aus Baumwolle mit BIC®-Logo. Die Preise beinhalten einen Digitaldruck auf der Schachtel und auf dem Malbuch. Aufdruck auf dem Beutel nach Wunsch. Die oben angegebenen Preise können je nach für den Beutel gewählter Personalisierungstechnik variieren / I set di penne per colorare BIC® comprendono una custodia personalizzata, un quaderno per colorare e una borsa in cotone con chiusura a cordoncino e logo BIC® impresso. I prezzi comprendono la personalizzazione a colori sulla scatola e sul quaderno per colorare. La stampa sulla borsa è opzionale. I suddetti prezzi possono variare in base alla tecnica di personalizzazione scelta per la borsa.

① Price under request. Prix sur demande / Precio bajo consulta / Preis auf Anfrage / Prezzi su richiesta.

**External packaging:**

Emballage externe / Envasado exterior / Außenverpackung / Imballaggio esterno.



± 10,8 Kg

## MOQ 500u.

### Decoration:

Personnalisation / Personalización  
/ Dekoration / Decorazione.

### BIC® EVOLUTION® ECOLUTIONS® COLOURING SET 1293



### BOX

C DG: 4-colour process

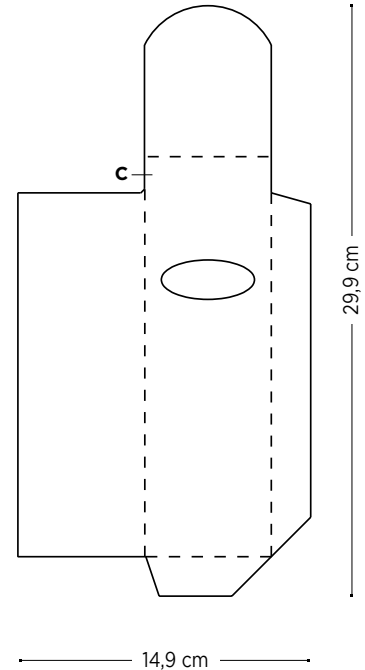

### BAG

No imprint (bag)

A SP (bag): max 2 col.

B OT (bag): full-colour

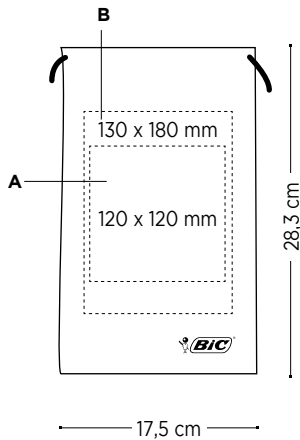

### BOOK

C DG: 4-colour process

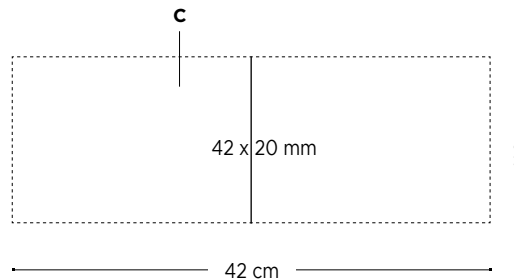

Price (€)

BIC® EVOLUTION® ECOLUTIONS® COLOURING SET 1293	500-999	1000-2499	2500-4999	5000-9999	10000-24999	25000-49999
No imprint (bag)	9,98	7,19	5,75	4,83	①	①
SP (bag)	10,85	7,91	6,41	5,48	①	①
OT (bag)	11,78	8,81	7,30	6,37	①	①
<b>Bag: additional imprint charge per colour &amp; position</b>						
SP	0,87	0,72	0,66	0,65	①	①
OT	1,80	1,62	1,55	1,54	①	①

**BIC® Colouring Pens sets are made up of a personalised box, a coloring book and a cotton drawing bag with BIC® logo. Prices include full colour personalisation on the box and the coloring book. Imprint on the bag is optional. Prices above vary according to the personalisation technique chosen for the bag.** Les sets de coloriage BIC® Colouring sont composés d'une boîte de crayons de couleur, d'un cahier de coloriage et d'un sac en coton à cordon coulissant portant le logo BIC®. Le prix inclut la personnalisation complète de la boîte à crayons et du cahier de coloriage. L'impression sur le sac est en option. Les prix ci-dessus varient en fonction de la technique de personnalisation choisie pour le sac / Los sets BIC® Colouring Pens están compuestos por una caja personalizada, un libro para colorear y una bolsa de algodón con el logo BIC®, Los precios incluyen la personalización a todo color en la caja y en el libro para colorear. La impresión en la bolsa es opcional. Los precios anteriores varían según la técnica de personalización elegida para la bolsa / BIC® Mal-Sets bestehen aus einer Schachtel, einem Malbuch und einem Kordelzugbeutel aus Baumwolle mit BIC®-Logo. Die Preise beinhalten einen Digitaldruck auf der Schachtel und auf dem Malbuch. Aufdruck auf dem Beutel nach Wunsch. Die oben angegebenen Preise können je nach für den Beutel gewählter Personalisierungstechnik variieren / I set di penna per colorare BIC® comprendono una custodia personalizzata, un quaderno per colorare e una borsa in cotone con chiusura a cordoncino e logo BIC® impresso. I prezzi comprendono la personalizzazione a colori sulla scatola e sul quaderno per colorare. La stampa sulla borsa è opzionale. I suddetti prezzi possono variare in base alla tecnica di personalizzazione scelta per la borsa.

① Price under request. Prix sur demande / Precio bajo consulta / Preis auf Anfrage / Prezzi su richiesta.

### External packaging:

Emballage externe / Envasado exterior / Außenverpackung / Imballaggio esterno.



100 ± 10,6 Kg



BY  COLOURING SET

BIC® Writing instruments • COLOURING PENS

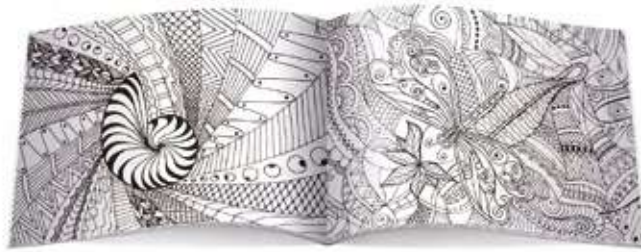

35%

**Writing modes:**

Mode écriture / Modos de escritura / Schreibmodi / Modalità di scrittura.



**Printing techniques:**

Techniques d'impression / Técnicas de impresión / Drucktechniken / Tecniche di stampa.



(SP) SCREEN PRINTING



(OT) OFFSET TRANSFER

**External packaging:**

Emballage externe / Envasado exterior / Außenverpackung / Imballaggio esterno.



100 ± 10,5 Kg

MOQ 500u.

**Decoration:**

Personalisation / Personalización / Dekoration / Decorazione.

**CONTÉ® BY BIC® COLOURING SET**

1292



**BOX**

**C DG:** 4-colour process

**BAG**

No imprint (bag)

**A SP** (bag): max 2 col.

**B OT** (bag): full-colour

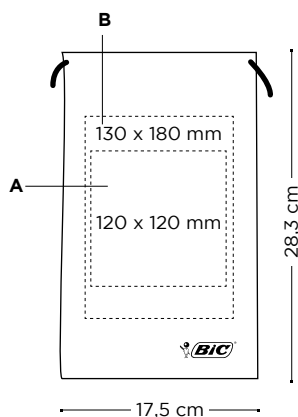

**BOOK**

**C DG:** 4-colour process

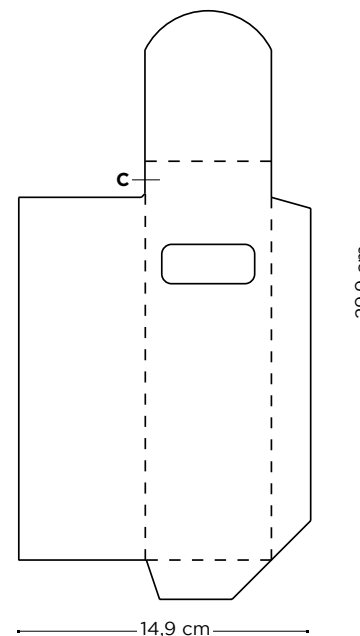
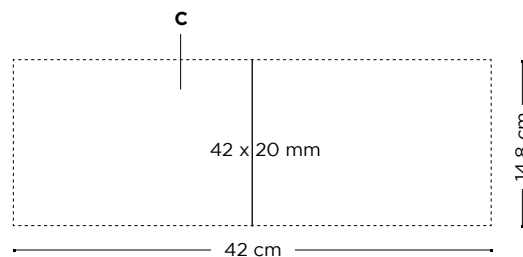

Price (€)

**CONTÉ® BY BIC® COLOURING SET**

1292	500-999	1000-2499	2500-4999	5000-9999	10000-24999	25000-49999
No imprint (bag)	10,35	7,55	6,15	5,14	①	①
<b>SP</b> (bag)	11,22	8,27	6,81	5,79	①	①
<b>OT</b> (bag)	12,15	9,17	7,70	6,68	①	①

**Bag: additional imprint charge per colour & position**

<b>SP</b>	0,87	0,72	0,66	0,65	①	①
<b>OT</b>	1,80	1,62	1,55	1,54	①	①

**BIC® Colouring Pens sets are made up of a personalised box, a coloring book and a cotton drawstring bag with BIC® logo. Prices include full colour personalisation on the box and the coloring book. Imprint on the bag is optional. Prices above vary according to the personalisation technique chosen for the bag.** Les sets de coloriage BIC® Colouring sont composés d'une boîte de crayons de couleur, d'un cahier de coloriage et d'un sac en coton à cordon coulissant portant le logo BIC®. Le prix inclut la personnalisation complète de la boîte à crayons et du cahier de coloriage. L'impression sur le sac est en option. Les prix ci-dessus varient en fonction de la technique de personnalisation choisie pour le sac / Los sets BIC® Colouring Pens están compuestos por una caja personalizada, un libro para colorear y una bolsa de algodón con el logo BIC®, Los precios incluyen la personalización a todo color en la caja y en el libro para colorear. La impresión en la bolsa es opcional. Los precios anteriores varían según la técnica de personalización elegida para la bolsa / BIC® Mal-Sets bestehen aus einer Schachtel, einem Malbuch und einem Kordelzugbeutel aus Baumwolle mit BIC®-Logo. Die Preise beinhalten einen Digitaldruck auf der Schachtel und auf dem Malbuch. Aufdruck auf dem Beutel nach Wunsch. Die oben angegebenen Preise können je nach für den Beutel gewählter Personalisierungstechnik variieren / I set di penne per colorare BIC® comprendono una custodia personalizzata, un quaderno per colorare e una borsa in cotone con chiusura a cordoncino e logo BIC® impresso. I prezzi comprendono la personalizzazione a colori sulla scatola e sul quaderno per colorare. La stampa sulla borsa è opzionale. I suddetti prezzi possono variare in base alla tecnica di personalizzazione scelta per la borsa.

① Price under request. Prix sur demande / Precio bajo consulta / Preis auf Anfrage / Prezzi su richiesta.

**Tipp-Ex** MINI POCKET MOUSE *britePix*™

The worldwide recognised correction tape Tipp-Ex® in its compact size, that provides an accurate application for both left and right-handed users with literally no dry time!

FR > Le ruban correcteur Tipp-Ex®, célèbre dans le monde entier, dans une taille compacte, idéale pour les trousseaux. 6 mètres de ruban plastique de large, 5 mm indéchirable, pour une application précise par les gauchers comme par les droitiers, le tout sans séchage!

DE > Der weltweit etablierte Tipp-Ex®-Korrekturstreifen in seiner kompakten Größe bietet sowohl für Links- als auch Rechtshänder eine optimale Anwendung - und das bei einer praktisch nicht vorhandenen Trockenzeit!

ES > El reconocido mundialmente corrector Tipp-Ex® en talla compacta, que aporta una aplicación precisa tanto para diestros como zurdos, sin tiempo de secado!

IT > Il correttore Tipp-Ex® riconosciuto in tutto il mondo nel formato compatto, fornisce una applicazione accurata sia per mancini che destrorsi senza necessità di asciugatura.





1354



51



51

**MOQ 250u.**

**Decoration:**

Personnalisation / Personalización / Dekoration / Decorazione.

**MINI POCKET MOUSE**

1354

**A/B BP:** full-colour

**BP Texture:** full-colour

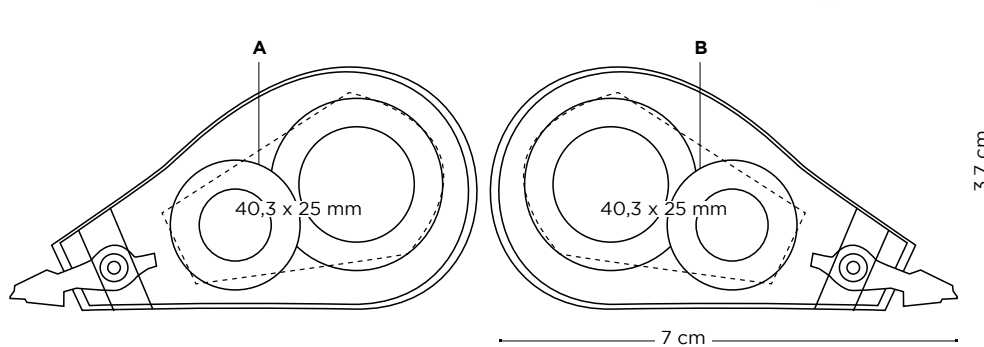

Price (€)

TIPP-EX® MINI POCKET MOUSE 1354	250-499	500-999	1000-2499	2500-4999	5000-9999	10000-24999	25000-49999
<b>BP</b>	1,86	1,76	1,66	1,57	1,47	①	①
<b>Additional charges:</b> Coûts supplémentaires: / Cargos adicionales: / Aufpreise: / Costi aggiuntivi:	0,70	0,64	0,59	0,56	0,54	①	①
<b>BP Texture</b>	0,53	0,48	0,44	0,42	0,41	①	①

**Prices include one imprint in one position according to specified technique.** Les prix incluent une impression sur un emplacement avec la technique spécifiée / Los precios incluyen una impresión en una posición acorde con la técnica especificada / In den Preisen inbegriffen ist ein Aufdruck auf einer Position gemäß angegebener Technik / I prezzi includono una stampa in una posizione a seconda della tecnica specificata.

① Price under request. Prix sur demande / Precio bajo consulta / Preis auf Anfrage / Prezzi su richiesta.

**Writing modes:**

Mode écriture / Modos de escritura / Schreibmodi / Modalità di scrittura.



**T**  
6 m

\*Source: GFK panel - Western Europe 9 - MAT June 2018 - Sales in Value & Volume

**Printing techniques:**

Techniques d'impression / Técnicas de impresión / Drucktechniken / Tecniche di stampa.



(BP) britePix™



**External packaging:**

Emballage externe / Envasado exterior / Außenverpackung / Imballaggio esterno.



**288 ± 3,2 Kg**

**Check out the video**

Regardez la video / Mira el video / Produktvideo / Guarda il video.



**PLASTIC PENS**

**176** Basic Pen

**178** Click Pen

**180** Stripped Grip Pen

**182** White Striped Grip Pen

**STYLUS PENS**

**184** Sleek Stylus Pen



# Other writing instruments

174 — 185

# BASIC PEN

12010

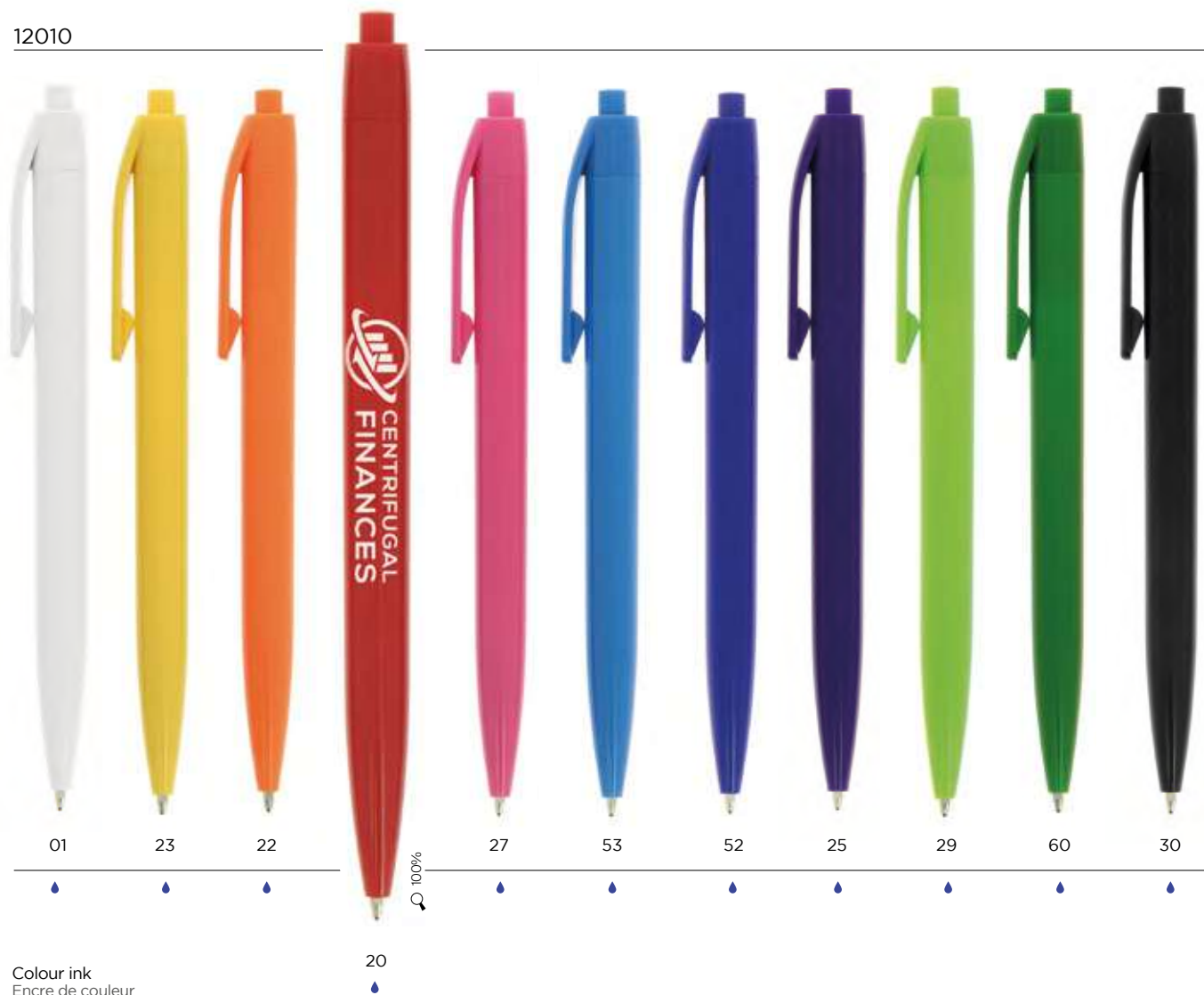

Colour ink  
Encre de couleur  
Color de la tinta  
Schreibfarbe  
Colore inchiostro

MOQ 500u.

**Decoration:**

Personnalisation / Personalización / Dekoration / Decorazione.

**BASIC PEN**

12010

A/B SP: max. 1 col.

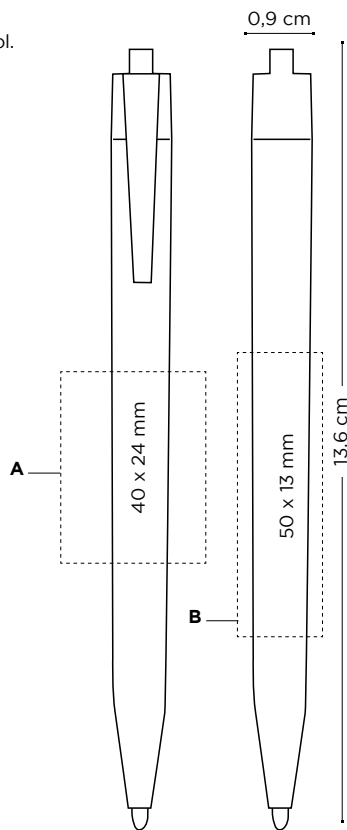

	Price (€)					
BASIC PEN	500-999	1000-2499	2500-4999	5000-9999	10000-24999	25000-49999
12010						
unimprinted	0,15	0,14	0,14	0,13	①	①
SP	0,50	0,39	0,33	0,30	①	①

**Prices include 1 colour screenprint in one position.** Les prix incluent la sérigraphie 1 couleur sur un emplacement / En precio incluye un color en serigrafía en una posición / In den Preisen inbegriffen ist 1 Siebdruck-Farbaufdruck auf 1 Position / I prezzi includono la serigrafia ad 1 colore in una posizione.  
 ① Price under request. Prix sur demande / Precio bajo consulta / Preis auf Anfrage / Prezzi su richiesta.

**Writing modes:**

Mode écriture / Modos de escritura / Schreibmodi / Modalità di scrittura.



**M**

**Printing techniques:**

Techniques d'impression / Técnicas de impresión / Drucktechniken / Tecniche di stampa.



(SP)  
 SCREEN  
 PRINTING

**External packaging:**

Emballage externe / Envasado exterior / Außenverpackung / Imballaggio esterno.



**1000** ± 12,5 Kg

# CLICK PEN

Other writing instruments • PLASTIC PENS

11748



Colour ink  
Encre de couleur  
Color de la tinta  
Schreibfarbe  
Colore inchiostro

## MOQ 500u.

### Decoration:

Personnalisation / Personalización / Dekoration / Decorazione.

### CLICK PEN

11748

**A/B SP:** max. 4 col.

**C/D PD:** max. 4 col.

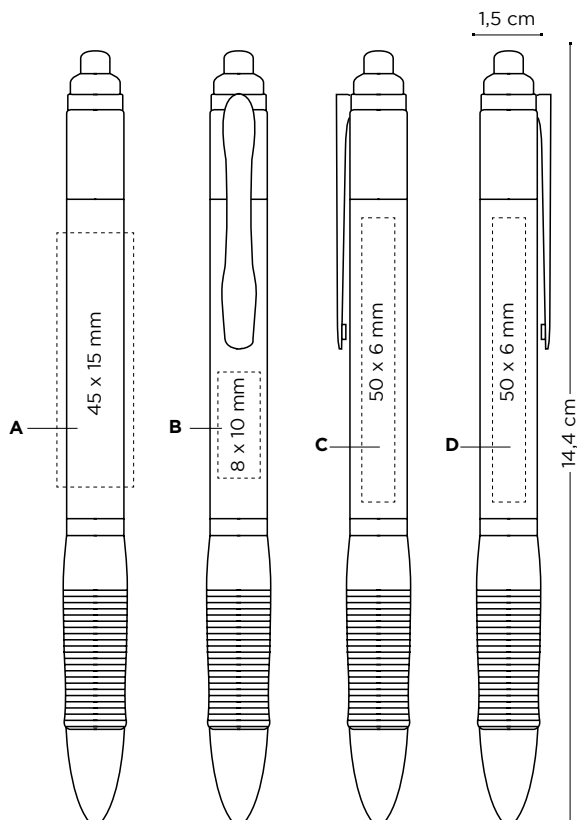

Price (€)

CLICK PEN	500-999	1000-2499	2500-4999	5000-9999	10000-24999	25000-49999
11748						
<b>unimprinted</b>	0,19	0,18	0,18	0,17	①	①
<b>SP</b>	0,54	0,43	0,37	0,34	①	①
<b>PD</b>	0,61	0,52	0,44	0,41	①	①

**Additional charges:** Coûts supplémentaires: / Cargos adicionales: / Aufpreise: / Costi aggiuntivi:

<b>SP</b>	0,13	0,13	0,13	0,12	①	①
<b>PD</b>	0,35	0,25	0,19	0,17	①	①

**Prices include one imprint in one position according to specified technique.** Les prix incluent une impression sur un emplacement avec la technique spécifiée / Los precios incluyen una impresión en una posición acorde con la técnica especificada / In den Preisen inbegriffen ist ein Aufdruck auf einer Position gemäß angegebener Technik / I prezzi includono una stampa in una posizione a seconda della tecnica specificata.

① Price under request. Prix sur demande / Precio bajo consulta / Preis auf Anfrage / Prezzi su richiesta.

### Writing modes:

Mode écriture / Modos de escritura / Schreibmodi / Modalità di scrittura.

Ballpen



**M**

### Printing techniques:

Techniques d'impression / Técnicas de impresión / Drucktechniken / Tecniche di stampa.



(SP) SCREEN PRINTING



(PD) PAD PRINTING

### External packaging:

Emballage externe / Envasado exterior / Außenverpackung / Imballaggio esterno.



**1000 ± 9,5 Kg**

# STRIPED GRIP PEN

11243

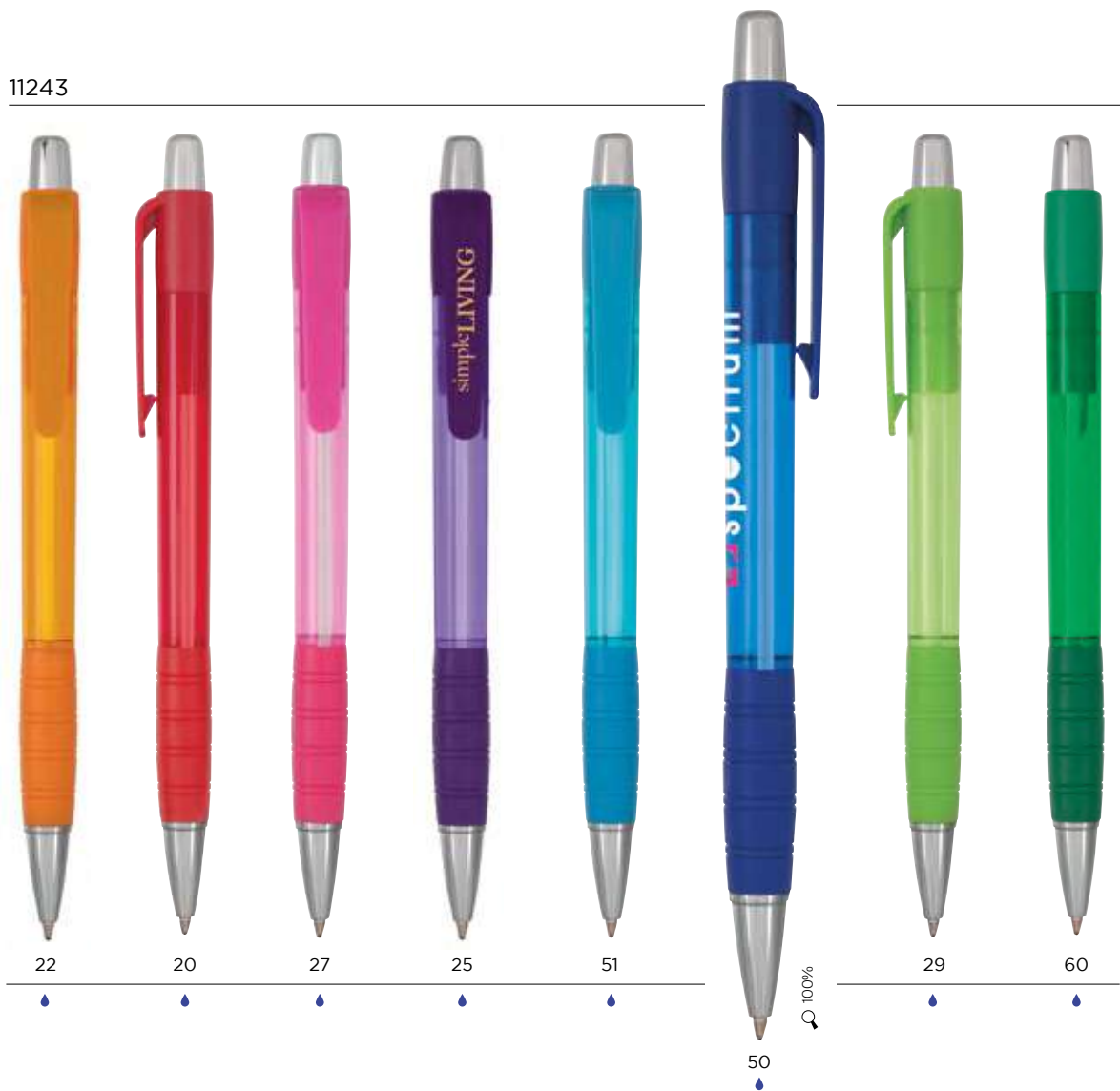

Colour ink  
Encre de couleur  
Color de la tinta  
Schreibfarbe  
Colore inchiostro

## MOQ 500u.

### Decoration:

Personnalisation / Personalización / Dekoration / Decorazione.

### STRIPED GRIP PEN

11243

**A SP:** max. 2 col.

**B PD:** max. 1 col.

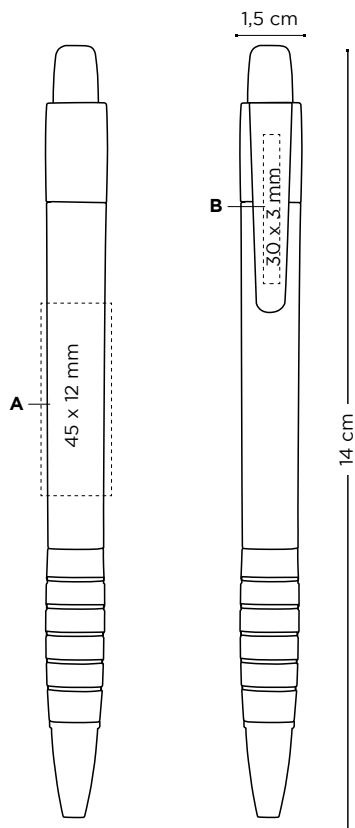

Price (€)

STRIPED GRIP PEN	500-999	1000-2499	2500-4999	5000-9999	10000-24999	25000-49999
11243						
<b>unimprinted</b>	0,29	0,28	0,28	0,26	①	①
<b>SP</b>	0,64	0,53	0,47	0,43	①	①
<b>PD</b>	0,71	0,62	0,54	0,50	①	①

**Additional charges:** Coûts supplémentaires: / Cargos adicionales: / Aufpreise: / Costi aggiuntivi:

<b>SP</b>	0,13	0,13	0,13	0,12	①	①
<b>PD</b>	0,35	0,25	0,19	0,17	①	①

**Prices include one imprint in one position according to specified technique.** Les prix incluent une impression sur un emplacement avec la technique spécifiée / Los precios incluyen una impresión en una posición acorde con la técnica especificada / In den Preisen inbegriffen ist ein Aufdruck auf einer Position gemäß angegebener Technik / I prezzi includono una stampa in una posizione a seconda della tecnica specificata.

① Price under request. Prix sur demande / Precio bajo consulta / Preis auf Anfrage / Prezzi su richiesta.

### Writing modes:

Mode écriture / Modos de escritura / Schreibmodi / Modalità di scrittura.

Ballpen



**M**

### Printing techniques:

Techniques d'impression / Técnicas de impresión / Drucktechniken / Tecniche di stampa.



(SP) SCREEN PRINTING



(PD) PAD PRINTING

### External packaging:

Emballage externe / Envasado exterior / Außenverpackung / Imballaggio esterno.



**1000 ± 9 Kg**

# WHITE STRIPED GRIP PEN

11303



20



27



50



100%



25



29



30



Colour ink  
Encre de couleur  
Color de la tinta  
Schreibfarbe  
Colore inchiostro



MOQ 500u.

**Decoration:**

Personnalisation / Personalización / Dekoration / Decorazione.

**WHITE STRIPED GRIP PEN**

11303

**A SP:** max. 2 col.

**B PD:** max. 1 col.

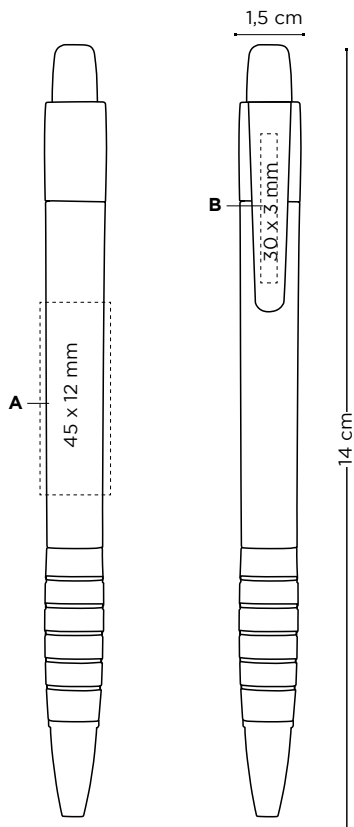

Price (€)

WHITE STRIPED GRIP PEN	500-999	1000-2499	2500-4999	5000-9999	10000-24999	25000-49999
11303						
<b>unimprinted</b>	0,29	0,28	0,28	0,26	①	①
<b>SP</b>	0,64	0,53	0,47	0,43	①	①
<b>PD</b>	0,71	0,62	0,54	0,50	①	①

**Additional charges:** Coûts supplémentaires: / Cargos adicionales: / Aufpreise: / Costi aggiuntivi:

<b>SP</b>	0,13	0,13	0,13	0,12	①	①
<b>PD</b>	0,35	0,25	0,19	0,17	①	①

**Prices include one imprint in one position according to specified technique.** Les prix incluent une impression sur un emplacement avec la technique spécifiée / Los precios incluyen una impresión en una posición acorde con la técnica especificada / In den Preisen inbegriffen ist ein Aufdruck auf einer Position gemäß angegebener Technik / I prezzi includono una stampa in una posizione a seconda della tecnica specificata.

① Price under request. Prix sur demande / Precio bajo consulta / Preis auf Anfrage / Prezzi su richiesta.

**Writing modes:**

Mode écriture / Modos de escritura / Schreibmodi / Modalità di scrittura.

Ballpen



**M**

**Printing techniques:**

Techniques d'impression / Técnicas de impresión / Drucktechniken / Tecniche di stampa.



(SP) SCREEN PRINTING



(PD) PAD PRINTING

**External packaging:**

Emballage externe / Envasado exterior / Außenverpackung / Imballaggio esterno.



**1000 ± 9 Kg**

# SLEEK STYLUS PEN

## SLEEK STYLUS PEN

11666



## SLEEK STYLUS MATT PEN

11747



## SLEEK STYLUS EXECUTIVE PEN

11976



Colour ink  
 Encre de couleur  
 Color de la tinta  
 Schreibfarbe  
 Colore inchiostro

**MOQ 100u. (LE)**  
**MOQ 500u. (SP)**

**Decoration:**

Personnalisation / Personalización  
 / Dekoration / Decorazione.

**SLEEK STYLUS PEN**

11666

**SLEEK STYLUS MATT PEN**

11747

**SLEEK STYLUS EXECUTIVE PEN**

11976

**A SP:** max. 1 col.

**B SP:** max. 2 col.

**C/D/E/F LE**

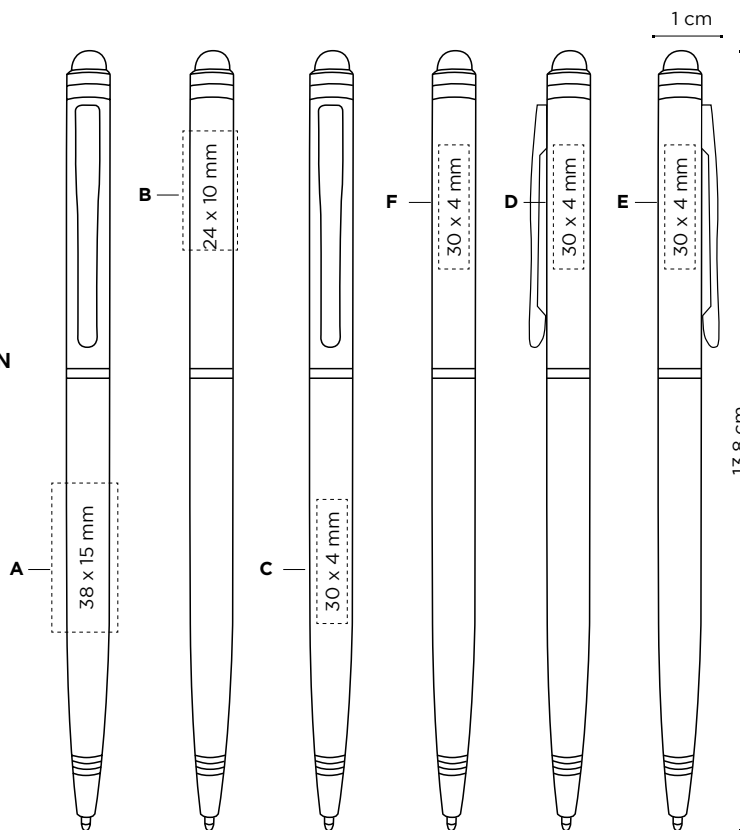

	Price (€)						
SLEEK STYLUS PEN	100-299	300-499	500-999	1000-2499	2500-4999	5000-9999	10000-24999
11666							
<b>unimprinted</b>	1,74	1,67	1,61	1,54	1,54	①	①
<b>SP</b>	-	2,30	2,11	1,94	1,88	①	①
<b>LE</b>	3,56	3,01	2,77	2,60	2,57	①	①
11747 / 11976							
<b>unimprinted</b>	1,86	1,79	1,71	1,64	1,64	①	①
<b>SP</b>	-	2,42	2,21	2,04	1,98	①	①
<b>LE</b>	3,68	3,13	2,87	2,70	2,67	①	①

**Additional charges:** Coûts supplémentaires: / Cargos adicionales: / Aufpreise: / Costi aggiuntivi:

<b>SP</b>	-	0,37	0,32	0,22	0,22	①	①
<b>LE</b>	1,82	1,34	1,16	1,06	1,03	①	①

**Prices include one imprint in one position according to specified technique.** Les prix incluent une impression sur un emplacement avec la technique spécifiée / Los precios incluyen una impresión en una posición acorde con la técnica especificada / In den Preisen inbegriffen ist ein Aufdruck auf einer Position gemäß angegebener Technik / I prezzi includono una stampa in una posizione a seconda della tecnica specificata.

① Price under request. Prix sur demande / Precio bajo consulta / Preis auf Anfrage / Prezzi su richiesta.

**Writing modes:**

Mode écriture / Modos de escritura / Schreibmodi / Modalità di scrittura.

Ballpen



**M**

Laser engraving not available in yellow/silver colour

**Printing techniques:**

Techniques d'impression / Técnicas de impresión / Drucktechniken / Tecniche di stampa.



(SP) SCREEN PRINTING



(LE) LASER

**External packaging:**

Emballage externe / Envasado exterior / Außenverpackung / Imballaggio esterno.



11666

**900 ± 12,4 Kg**



11747  
11976

**800 ± 13 Kg**

#### **ADHESIVE NOTEPADS**

- 190** BIC® 50 mm x 75 mm  
Adhesive Notepads
- 192** BIC® 68 mm x 75 mm  
Adhesive Notepads
- 194** BIC® 75 mm x 75 mm  
Adhesive Notepads
- 196** BIC® Small Adhesive Die  
Cut Notepads
- 198** BIC® 101 mm x 75 mm  
Adhesive Notepads  
& BIC® 101 mm x 75 mm  
Alternating Sheet Imprint
- 200** BIC® Medium Adhesive  
Die Cut Notepads
- 202** BIC® 101 mm x 101 mm  
Adhesive Notepads
- 204** BIC® 101 mm x 130 mm  
Adhesive Notepads

#### **SCRATCH PADS**

- 206** BIC® 75 x 127 mm  
Non-Adhesive Scratch Pad
- 207** BIC® 96 x 152 mm  
Non-Adhesive Scratch Pad

#### **BOOKLETS**

- 210** BIG Flag Booklet
- 212** BIC® 75 x 75 Booklet
- 214** BIC® 101 x 75 Booklet
- 216** BIC® 75 x 75 Adhesive  
Notepad With Flag Booklet
- 218** BIC® Clic Stic Organiser  
& BIC® Clic Stic Mini  
Digital Organiser
- 222** BIC® 150 x 150 mm Booklet  
Organiser
- 224** BIC® 150 x 150 mm Booklet  
With Pen Loop



# Sticky notes

186 — 225

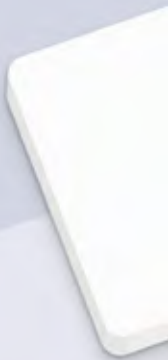



BIC® Sticky Notes, an indispensable tool in any office. Choose between a wide range of sizes and forms, sticky and non sticky.

FR > Les BIC® Sticky Notes : le matériel de bureau indispensable. Faites votre choix parmi une multitude de tailles et de formes, adhésifs ou non.

DE > BIC Sticky Notes, unverzichtbar in jedem Büro. Wählen Sie aus einer Vielzahl von Größen und Designs, mit und ohne Haftstreifen.

ES > Las BIC® Sticky Notes son una herramienta indispensable en cualquier oficina. Elige entre gran variedad de tamaños y formas, con y sin adhesivo.

IT > BIC® Sticky Notes è uno strumento indispensabile in qualsiasi ufficio. Scegli tra una vasta gamma di dimensioni e forme, Riposizionabili e non.

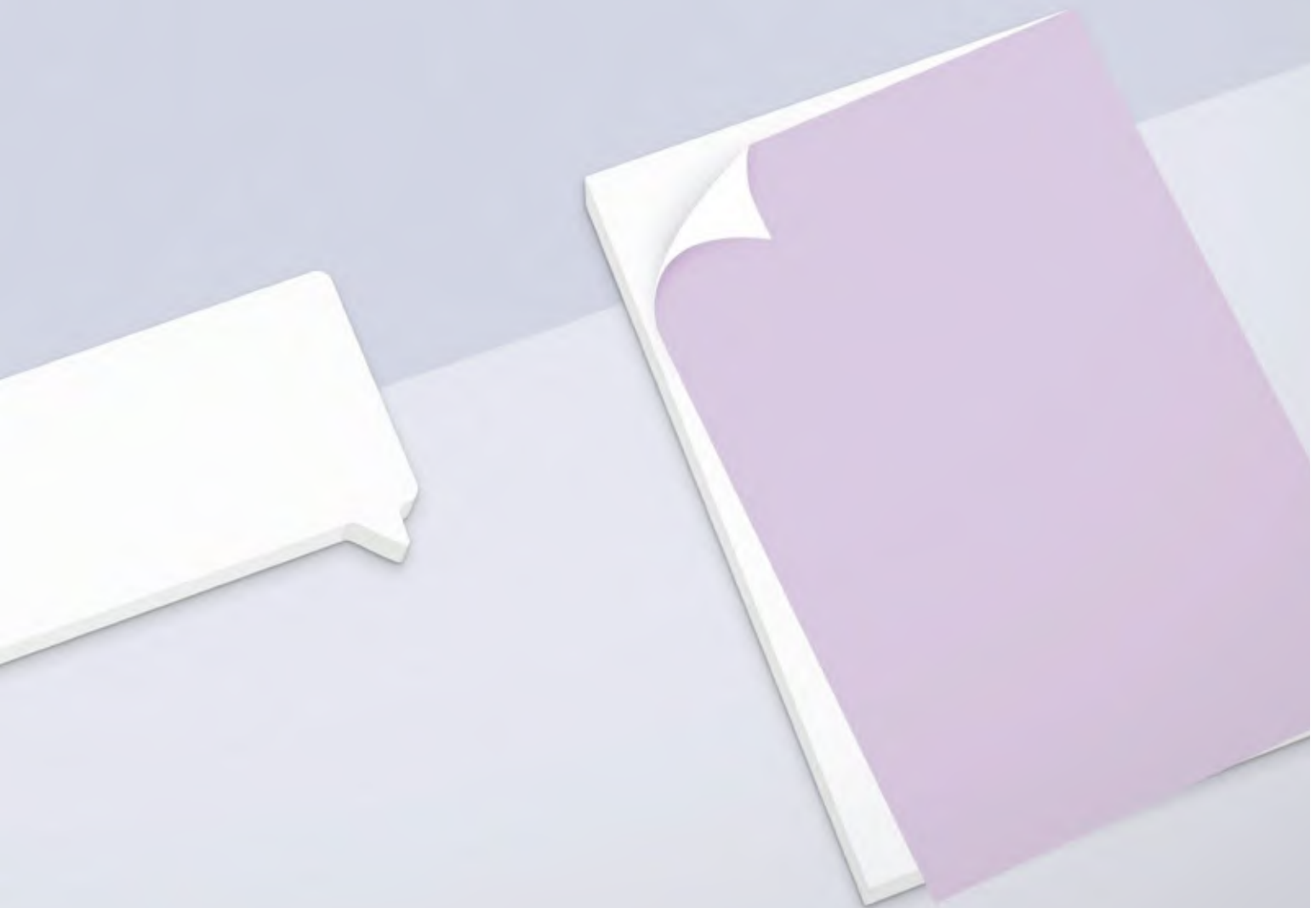



# 50 MM X 75 MM ADHESIVE NOTEPADS

ecolutions® VERSION AVAILABLE

MADE WITH 100% FSC CERTIFIED PAPER  
& 100% RECYCLABLE



*Ideal pocket size  
for mailing campaigns!*

BIC® sticky notes • ADHESIVE NOTEPADS

### Exact colour match:

Correspondance exacte des couleurs / Color exacto / Exakte Farbübereinstimmung / Esatta corrispondenza di colore.

≥ 500 units

### Paper type:

Type de papier / Tipo de papel / Papierart / Tipo carta.

- Standard 80g
- Recycled 80g

### Special packaging:

Emballage spécial / Envasado especial / Preis auf Anfrage / Confezione speciale.

### shrink-wrapped

N° Sheets	Units per pack
25	10
50	5
100	1

Optional Packaging:  
Cello Wrap 1, 2, 3 units

### Printing techniques:

Techniques d'impression / Técnicas de impresión / Drucktechniken / Tecniche di stampa.



(DG)  
DIGITAL



MADE IN SPAIN



**ECOLUTIONS VERSION: MADE OF 100% RECYCLED FIBRE\* & 100% RECYCLABLE**  
**NON ECOLUTIONS VERSION: MADE WITH 100% FSC CERTIFIED PAPER & 100% RECYCLABLE**



**Decoration:**

Personnalisation / Personalización / Dekoration / Decorazione.

**BIC® 50 MM X 75 MM MOQ 500u.**



**ADHESIVE NOTEPADS**

**A DG: 4-colour process**

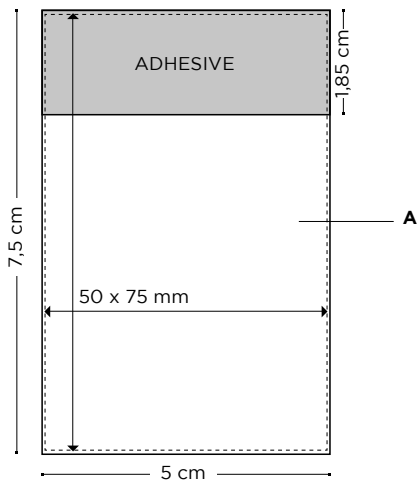
-  25 **3522**  
@ecolutions® 3520
-  50 **3552**  
@ecolutions® 3550
-  100 **3582**  
@ecolutions® 3580



Price (€)

		500-999	1000-2499	2500-4999	5000-9999	10000-24999	25000-49999
	<b>BIC® 50 MM X 75 MM ADHESIVE NOTEPADS</b>						
	<b>3522</b>						
	<b>DG</b>	0,47	0,39	0,26	0,22	0,22	0,22
	@ecolutions® 3520						
	<b>DG</b>	0,53	0,44	0,30	0,25	①	①
	<b>3552</b>						
	<b>DG</b>	0,78	0,59	0,39	0,33	0,32	0,31
	@ecolutions® 3550						
	<b>DG</b>	0,88	0,67	0,43	0,37	①	①
	<b>3582</b>						
	<b>DG</b>	1,17	0,96	0,70	0,54	0,53	0,52
	@ecolutions® 3580						
	<b>DG</b>	1,30	1,07	0,77	0,60	①	①

**Additional charges:** Coûts supplémentaires: / Cargos adicionales: / Aufpreise: / Costi aggiuntivi:

**Exact colour match on pad** 105€

**Prices include 4-colour process imprint.** Les prix incluent l'impression en quadrichromie / Los precios incluyen una impresión en cuatricromía / In den Preisen inbegriffen ist der Vierfarbdruck-Aufdruck / I prezzi includono la stampa con processo in quadricromia.

**Orders must be multiples of the minimum order quantity.** Les commandes doivent être un multiple de la quantité minimum indiquée / Los pedidos deben ser múltiplos de la cantidad mínima de pedido / Bestellungen müssen das Vielfache der Mindestbestellmenge / Gli ordini devono essere multipli della quantità minima.

**Additional charge for shrink-wrapped pack: 0,11€.** Coût additionnelle pour emballage sous film: 0,11€ / Coste adicional por el retractilado: 0,11€ / Aufpreis für eingeschweißte Einzel-Mehrverpackung 0,11€ / Supplemento per blister 0,11€.

① Price under request. Prix sur demande / Precio bajo consulta / Preis auf Anfrage / Prezzi su richiesta

**External packaging:**

Emballage externe / Envasado exterior / Außenverpackung / Imballaggio esterno.



**1000** ± 8,7 Kg



**500** 8,5 Kg



**250** ± 8,4 Kg

\*The percentage is calculated excluding backsheet.

\*Pourcentage calculé hors dernière page.

\*Porcentaje calculado excluyendo la última página.

\*Der Prozentsatz ist ohne Rückblatt kalkuliert

\*La percentuale è calcolata escludendo il cartoncino di fondo.



68 MM X 75 MM ADHESIVE NOTEPADS

ecolutions® VERSION AVAILABLE



130%



Sticky Notes ideal to always take your messages with you!

**Exact colour match:**

Correspondance exacte des couleurs / Color exacto / Exakte Farbübereinstimmung / Esatta corrispondenza di colore.

≥ 500 units

**Paper type:**

Type de papier / Tipo de papel / Papierart / Tipo carta.

- Standard 80g
- Recycled 80g

**Special packaging:**

Emballage spécial / Envasado especial / Preis auf Anfrage / Confezione speciale.

**shrink-wrapped**

N° Sheets	Units per pack
25	10
50	5
100	1

Optional Packaging:  
Cello Wrap 1, 2, 3 units

**Printing techniques:**

Techniques d'impression / Técnicas de impresión / Drucktechniken / Tecniche di stampa.



(DG)  
DIGITAL





MADE IN SPAIN

**ECOLUTIONS VERSION: MADE OF 100% RECYCLED FIBRE\* & 100% RECYCLABLE**  
**NON ECOLUTIONS VERSION: MADE WITH 100% FSC CERTIFIED PAPER & 100% RECYCLABLE**



**Decoration:**

Personnalisation / Personalización / Dekoration / Decorazione.

**BIC® 68 MM X 75 MM** **MOQ 500u.**  
**ADHESIVE NOTEPADS**  
**A DG: 4-colour process**

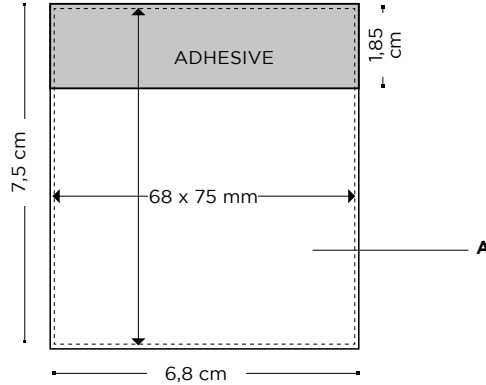
-  25 3502 @ccolutions® 3500
-  50 3532 @ccolutions® 3530
-  100 3562 @ccolutions® 3560



		Price (€)					
		500-999	1000-2499	2500-4999	5000-9999	10000-24999	25000-49999
	<b>BIC® 68 MM X 75 MM</b>						
	<b>ADHESIVE NOTEPADS</b>						
	3502						
	<b>DG</b>	0,56	0,46	0,30	0,24	0,24	0,24
	@ccolutions® 3500						
	<b>DG</b>	0,62	0,51	0,33	0,27	①	①
	3532						
	<b>DG</b>	0,85	0,63	0,46	0,37	0,36	0,35
	@ccolutions® 3530						
	<b>DG</b>	0,94	0,69	0,51	0,41	①	①
	3562						
	<b>DG</b>	1,20	1,02	0,80	0,67	0,66	0,65
	@ccolutions® 3560						
	<b>DG</b>	1,33	1,13	0,89	0,74	①	①

**Additional charges:** Coûts supplémentaires: / Cargos adicionales: / Aufpreise: / Costi aggiuntivi:

**Exact colour match on pad** 105€

**Prices include 4-colour process imprint.** Les prix incluent l'impression en quadrichromie / Los precios incluyen una impresión en cuatricromía / In den Preisen inbegriffen ist der Vierfarbdruck-Aufdruck / I prezzi includono la stampa con processo in quadricromia.

**Orders must be multiples of the minimum order quantity.** Les commandes doivent être un multiple de la quantité minimum indiquée / Los pedidos deben ser múltiples de la cantidad mínima de pedido / Bestellungen müssen das Vielfache der Mindestbestellmenge / Gli ordini devono essere multipli della quantità minima.

**Additional charge for shrink-wrapped pack: 0,11€.** Coût additionnelle pour emballage sous film: 0,11€ / Coste adicional por el retractilado: 0,11€ / Aufpreis für eingeschweißte Einzel-Mehrverpackung 0,11€ / Supplemento per blister 0,11€.

① Price under request. Prix sur demande / Precio bajo consulta / Preis auf Anfrage / Prezzi su richiesta

**External packaging:**

Emballage externe / Envasado exterior / Außenverpackung / Imballaggio esterno.



\*The percentage is calculated excluding backsheet.

\*Pourcentage calculé hors dernière page.

\*Porcentaje calculado excluyendo la última página.

\*Der Prozentsatz ist ohne Rückblatt kalkuliert

\*La percentuale è calcolata escludendo il cartoncino di fondo.

ecolutions® VERSION AVAILABLE

MADE WITH 100% FSC CERTIFIED PAPER  
& 100% RECYCLABLE



130%



Large imprint area in a small size!

**Exact colour match:**

Correspondance exacte des couleurs / Color exacto / Exakte Farbübereinstimmung / Esatta corrispondenza di colore.

≥ 500 units

**Paper type:**

Type de papier / Tipo de papel / Papierart / Tipo carta.

- Standard 80g
- Recycled 80g

**Special packaging:**

Emballage spécial / Envasado especial / Preis auf Anfrage / Confezione speciale.

**shrink-wrapped**

N° Sheets	Units per pack
25	10
50	5
100	1

Optional Packaging:  
Cello Wrap 1, 2, 3 units

**Printing techniques:**

Techniques d'impression / Técnicas de impresión / Drucktechniken / Tecniche di stampa.



(DG)  
DIGITAL



MADE IN SPAIN

**ECOLUTIONS VERSION: MADE OF 100% RECYCLED FIBRE\* & 100% RECYCLABLE**  
**NON ECOLUTIONS VERSION: MADE WITH 100% FSC CERTIFIED PAPER & 100% RECYCLABLE**



**Decoration:**

Personnalisation / Personalización / Dekoration / Decorazione.





**BIC® 75 MM X 75 MM MOQ 500u.**

**ADHESIVE NOTEPADS**

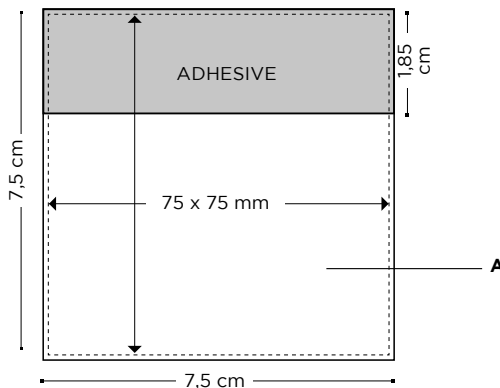
**A DG: 4-colour process**

-  25 **3507**  
**ecolutions® 3505**
-  50 **3537**  
**ecolutions® 3535**
-  100 **3567**  
**ecolutions® 3565**



		Price (€)					
		500-999	1000-2499	2500-4999	5000-9999	10000-24999	25000-49999
	<b>BIC® 75 MM X 75 MM ADHESIVE NOTEPADS</b>						
	<b>3507</b>						
	<b>DG</b>	0,59	0,48	0,33	0,26	0,25	0,25
	<b>ecolutions® 3505</b>						
	<b>DG</b>	0,65	0,52	0,37	0,29	①	①
	<b>3537</b>						
	<b>DG</b>	0,87	0,65	0,48	0,41	0,40	0,39
	<b>ecolutions® 3535</b>						
	<b>DG</b>	0,96	0,72	0,53	0,46	①	①
	<b>3567</b>						
	<b>DG</b>	1,24	1,07	0,89	0,83	0,81	0,79
	<b>ecolutions® 3565</b>						
<b>DG</b>	1,38	1,19	0,99	0,92	①	①	

**Additional charges:** Coûts supplémentaires: / Cargos adicionales: / Aufpreise: / Costi aggiuntivi:

**Exact colour match on pad** 105€

**Prices include 4-colour process imprint.** Les prix incluent l'impression en quadrichromie / Los precios incluyen una impresión en cuatricromía / In den Preisen inbegriffen ist der Vierfarbdruck-Aufdruck / I prezzi includono la stampa con processo in quadricromia.

**Orders must be multiples of the minimum order quantity.** Les commandes doivent être un multiple de la quantité minimum indiquée / Los pedidos deben ser múltiples de la cantidad mínima de pedido / Bestellungen müssen das Vielfache der Mindestbestellmenge / Gli ordini devono essere multipli della quantità minima.

**Additional charge for shrink-wrapped pack: 0,11€.** Coût additionnelle pour emballage sous film: 0,11€ / Coste adicional por el retractilado: 0,11€ / Aufpreis für eingeschweißte Einzel-Mehrverpackung 0,11€ / Supplemento per blister 0,11€.

① Price under request. Prix sur demande / Precio bajo consulta / Preis auf Anfrage / Prezzi su richiesta

**External packaging:**

Emballage externe / Envasado exterior / Außenverpackung / Imballaggio esterno.





Choose from 7 stock shapes!  
Custom-made shapes available upon request

BIC® sticky notes • ADHESIVE NOTEPADS

**Exact colour match:**

Correspondance exacte des couleurs / Color exacto / Exakte Farbübereinstimmung / Esatta corrispondenza di colore.

≥ 500 units

**Paper type:**

Type de papier / Tipo de papel / Papierart / Tipo carta.

Standard 80g

**Special packaging:**

Emballage spécial / Envasado especial / Preis auf Anfrage / Confezione speciale.

**shrink-wrapped**

N° Sheets	Units per pack
25	10
50	5
100	1

Optional Packaging:  
Cello Wrap 1, 2, 3 units

**Printing techniques:**

Techniques d'impression / Técnicas de impresión / Drucktechniken / Tecniche di stampa.



(DG)  
DIGITAL



MADE IN SPAIN

MADE WITH 100% FSC CERTIFIED PAPER  
& 100% RECYCLABLE

**Decoration:**

Personnalisation / Personalización / Dekoration / Decorazione.

**BIC® SMALL ADHESIVE** **MOQ 500u.**

**DIE CUT NOTEPADS**

**A DG:** 4-colour process



 25 3603

 50 3607

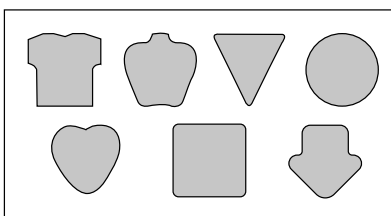
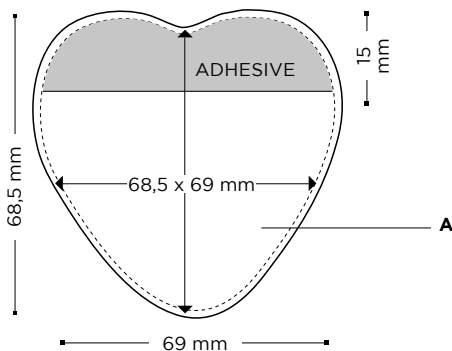
 100 3611



Price (€)

BIC® SMALL ADHESIVE DIE CUT NOTEPAD		500-999	1000-2499	2500-4999	5000-9999	10000-24999	25000-49999
 25	3603						
	<b>DG</b>	0,97	0,77	0,53	0,43	0,42	0,41
 50	3607						
	<b>DG</b>	1,47	1,10	0,80	0,70	0,69	0,68
 100	3611						
	<b>DG</b>	2,28	1,97	1,64	1,52	1,49	1,46

**Additional charges:** Coûts supplémentaires: / Cargos adicionales: / Aufpreise: / Costi aggiuntivi:

**Exact colour match on pad** 105€

**Custom made shape set up charge (per order &/or shape)** 1195€

**Repeat order** Free

**Prices include 4-colour process imprint.** Les prix incluent l'impression en quadrichromie / Los precios incluyen una impresión en cuatricromía / In den Preisen inbegriffen ist der Vierfarbdruck-Aufdruck / I prezzi includono la stampa con processo in quadricromia.

**Orders must be multiples of the minimum order quantity.** Les commandes doivent être un multiple de la quantité minimum indiquée / Los pedidos deben ser múltiples de la cantidad mínima de pedido / Bestellungen müssen das Vielfache der Mindestbestellmenge / Gli ordini devono essere multipli della quantità minima.

**Additional charge for shrink-wrapped pack: 0,11€.** Coût additionnelle pour emballage sous film: 0,11€ / Coste adicional por el retractilado: 0,11€ / Aufpreis für eingeschweißte Einzel-Mehrverpackung 0,11€ / Supplemento per blister 0,11€.

**External packaging:**

Emballage externe / Envasado exterior / Außenverpackung / Imballaggio esterno.

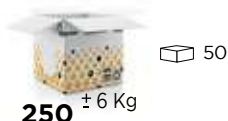



**101 MM X 75 MM ADHESIVE NOTEPADS  
& BIC® 101 MM X 75 MM ALTERNATING SHEET IMPRINT**

**ecolutions®** VERSION AVAILABLE

MADE WITH 100% FSC CERTIFIED PAPER  
& **100% RECYCLABLE**



Indispensable in any office!  
Most popular sticky notes pad size!



100%



Alternate 2 messages for double-impact communication!

BIC® sticky notes • ADHESIVE NOTEPADS

**Exact colour match:**

Correspondance exacte des couleurs / Color exacto / Exakte Farbübereinstimmung / Esatta corrispondenza di colore.

≥ 500 units

**Paper type:**

Type de papier / Tipo de papel / Papierart / Tipo carta.

- Standard 80g
- Recycled 80g

**Special packaging:**

Emballage spécial / Envasado especial / Preis auf Anfrage / Confezione speciale.

**shrink-wrapped**

N° Sheets	Units per pack
25	10
50	5
100	1

Optional Packaging:  
Cello Wrap 1, 2, 3 units

**Printing techniques:**

Techniques d'impression / Técnicas de impresión / Drucktechniken / Tecniche di stampa.



(DG)  
DIGITAL



MADE IN SPAIN









**ECOLUTIONS VERSION: MADE OF 100% RECYCLED FIBRE\* & 100% RECYCLABLE**  
**NON ECOLUTIONS VERSION: MADE WITH 100% FSC CERTIFIED PAPER & 100% RECYCLABLE**

**Decoration:**

Personnalisation / Personalización / Dekoration / Decorazione.

**BIC® 101 MM X 75 MM ADHESIVE NOTEPADS & ALTERNATING SHEET IMPRINT**

**A DG:** 4-colour process

-  25  
 **3510**  
 Alternating Sheet 3514
-  50  
 **3540**  
 Alternating Sheet 3544
-  100  
 **3570**





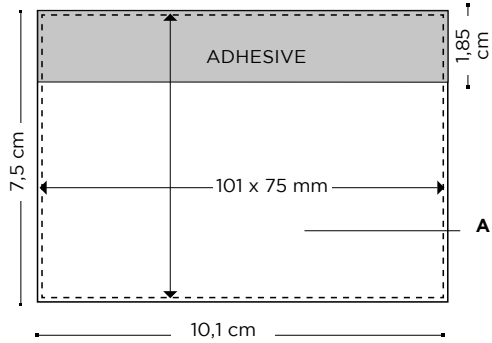

**MOQ 500u.**

**MOQ 250u.**

**MOQ 500u.**



Price (€)

		250-499	500-999	1000-2499	2500-4999	5000-9999	10000-24999	25000-49999
<b>BIC® 101 MM X 75 MM ADHESIVE NOTEPADS &amp; ALTERNATING SHEET</b>								
3512								
	<b>DG</b>	-	0,70	0,54	0,41	0,33	0,32	0,31
	 <b>3510</b>							
	<b>DG</b>	-	0,78	0,61	0,46	0,37	①	①
	Alternating Sheet 3514							
	<b>DG</b>	-	0,70	0,54	0,41	0,33	0,32	0,31
3542								
	<b>DG</b>	1,13	0,96	0,80	0,59	0,52	0,51	0,50
	 <b>3540</b>							
	<b>DG</b>	1,26	1,07	0,89	0,66	0,58	①	①
	Alternating Sheet 3544							
	<b>DG</b>	1,13	0,96	0,80	0,59	0,52	0,51	0,50
3572								
	<b>DG</b>	-	1,59	1,28	1,11	1,00	0,98	0,96
	 <b>3570</b>							
	<b>DG</b>	-	1,79	1,43	1,25	1,12	①	①

**Additional charges:** Coûts supplémentaires / Cargos adicionales / Aufpreise / Costi aggiuntivi:

**Exact colour match on pad** 105€

**Prices include 4-colour process imprint.** Les prix incluent l'impression en quadrichromie / Los precios incluyen una impresión en cuatricromía / In den Preisen inbegriffen ist der Vierfarbdruck-Aufdruck / I prezzi includono la stampa con processo in quadricromia.

**Orders must be multiples of the minimum order quantity.** Les commandes doivent être un multiple de la quantité minimum indiquée / Los pedidos deben ser multiples de la cantidad mínima de pedido / Bestellungen müssen das Vielfache der Mindestbestellmenge / Gli ordini devono essere multipli della quantità minima.

**Additional charge for shrink-wrapped pack: 0,11€.** Coût additionnelle pour emballage sous film: 0,11€ / Coste adicional por el retráctilado: 0,11€ / Aufpreis für eingeschweißte Einzel-Mehrverpackung 0,11€ / Supplemento per blister 0,11€.

① Price under request. Prix sur demande / Precio bajo consulta / Preis auf Anfrage / Prezzi su richiesta

**External packaging:**

Emballage externe / Envasado exterior / Außenverpackung / Imballaggio esterno.



 25

**500** ± 8,2 Kg



 50

**250** ± 8 Kg



 100

**130** ± 8,3 Kg

\*The percentage is calculated excluding backsheet.

\*Pourcentage calculé hors dernière page.

\*Porcentaje calculado excluyendo la última página.

\*Der Prozentsatz ist ohne Rückblatt kalkuliert

\*La percentuale è calcolata escludendo il cartoncino di fondo.



# MEDIUM ADHESIVE DIE CUT NOTEPADS

ecolutions® VERSION AVAILABLE

MADE WITH 100% FSC CERTIFIED PAPER  
& 100% RECYCLABLE



125%



Choose from 28 stock shapes!  
Custom-made shapes also available upon request

### Exact colour match:

Correspondance exacte des couleurs / Color exacto / Exakte Farbübereinstimmung / Esatta corrispondenza di colore.

≥ 500 units

### Paper type:

Type de papier / Tipo de papel / Papierart / Tipo carta.

- Standard 80g
- Recycled 80g

### Special packaging:

Emballage spécial / Envasado especial / Preis auf Anfrage / Confezione speciale.

### shrink-wrapped

N° Sheets	Units per pack
25	10
50	5
100	1

Optional Packaging:  
Cello Wrap 1, 2, 3 units

### Printing techniques:

Techniques d'impression / Técnicas de impresión / Drucktechniken / Tecniche di stampa.



(DG)  
DIGITAL



MADE IN SPAIN

**ECOLUTIONS VERSION: MADE OF 100% RECYCLED FIBRE\* & 100% RECYCLABLE**  
**NON ECOLUTIONS VERSION: MADE WITH 100% FSC CERTIFIED PAPER & 100% RECYCLABLE**







**Decoration:**

Personnalisation / Personalización / Dekoration / Decorazione.

**BIC® MEDIUM ADHESIVE  
 DIE CUT NOTEPADS**





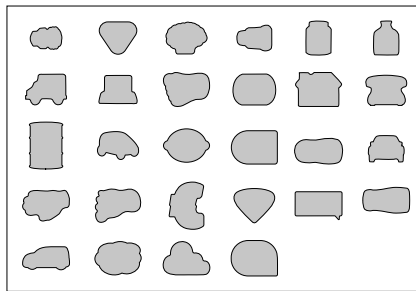
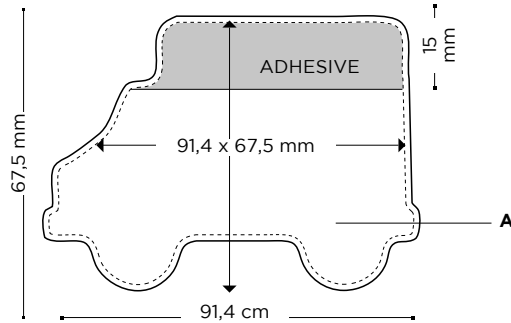

**MOQ 500u.**

**A DG:** 4-colour process

-  25  3602
-  50  3606
-  100  3610



Price (€)

BIC® MEDIUM ADHESIVE DIE CUT NOTEPADS		500-999	1000-2499	2500-4999	5000-9999	10000-24999	25000-49999
 25	3604						
	<b>DG</b>	1,07	0,83	0,64	0,50	0,49	0,48
 50	 3602						
	<b>DG</b>	1,17	0,91	0,69	0,55	①	①
 100	3608						
	<b>DG</b>	1,84	1,42	1,05	0,90	0,88	0,86
 3606							
	<b>DG</b>	1,98	1,54	1,13	0,97	①	①
 3610							
	<b>DG</b>	2,79	2,25	1,95	1,76	1,72	1,69
 3610							
	<b>DG</b>	3,24	2,60	2,26	2,04	①	①

**Additional charges:** Coûts supplémentaires: / Cargos adicionales: / Aufpreise: / Costi aggiuntivi:

**Exact colour match on pad** 105€

**Custom made shape set up charge (per order &/or shape)** 1195€

**Repeat order** Free

**Prices include 4-colour process imprint.** Les prix incluent l'impression en quadrichromie / Los precios incluyen una impresión en cuatricromia / In den Preisen inbegriffen ist der Vierfarbdruck-Aufdruck / I prezzi includono la stampa con processo in quadricromia.

**Orders must be multiples of the minimum order quantity.** Les commandes doivent être un multiple de la quantité minimum indiquée / Los pedidos deben ser múltiplos de la cantidad mínima de pedido / Bestellungen müssen das Vielfache der Mindestbestellmenge / Gli ordini devono essere multipli della quantità minima.

**Additional charge for shrink-wrapped pack: 0,11€.** Coût additionnelle pour emballage sous film: 0,11€ / Coste adicional por el retractilado: 0,11€ / Aufpreis für eingeschweißte Einzel-Mehrverpackung 0,11€ / Supplemento per blister 0,11€.

① Price under request. Prix sur demande / Precio bajo consulta / Preis auf Anfrage / Prezzi su richiesta

**External packaging:**

Emballage externe / Envasado exterior / Außenverpackung / Imballaggio esterno.



\*The percentage is calculated excluding backsheets.

\*Pourcentage calculé hors dernière page.

\*Porcentaje calculado excluyendo la última página.

\*Der Prozentsatz ist ohne Rückblatt kalkuliert

\*La percentuale è calcolata escludendo il cartoncino di fondo.



# 101 MM X 101 MM ADHESIVE NOTEPADS

ecolutions® VERSION AVAILABLE

MADE WITH 100% FSC CERTIFIED PAPER  
& 100% RECYCLABLE



BIC® sticky notes • ADHESIVE NOTEPADS

100%

70%

Take advantage of this large imprint area!

### Exact colour match:

Correspondance exacte des couleurs / Color exacto / Exakte Farbübereinstimmung / Esatta corrispondenza di colore.

≥ 500 units

### Paper type:

Type de papier / Tipo de papel / Papierart / Tipo carta.

- Standard 80g
- Recycled 80g

### Special packaging:

Emballage spécial / Envasado especial / Preis auf Anfrage / Confezione speciale.

### shrink-wrapped

N° Sheets	Units per pack
25	10
50	5
100	1

Optional Packaging:  
Cello Wrap 1, 2, 3 units

### Printing techniques:

Techniques d'impression / Técnicas de impresión / Drucktechniken / Tecniche di stampa.



(DG)  
DIGITAL



MADE IN SPAIN

**ECOLUTIONS VERSION: MADE OF 100% RECYCLED FIBRE\* & 100% RECYCLABLE**  
**NON ECOLUTIONS VERSION: MADE WITH 100% FSC CERTIFIED PAPER & 100% RECYCLABLE**







**Decoration:**

Personnalisation / Personalización / Dekoration / Decorazione.

**BIC® 101 MM X 101 MM** **MOQ 500u.**





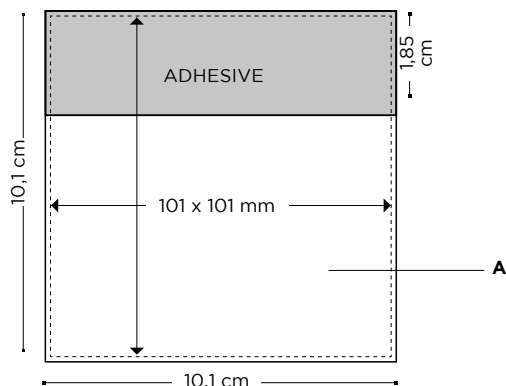

**ADHESIVE NOTEPADS**

**A DG: 4-colour process**

-  25  **3518**
-  50  **3548**
-  100  **3578**



Price (€)

<b>BIC® 101 MM X 101 MM</b>		500-999	1000-2499	2500-4999	5000-9999	10000-24999	25000-49999
<b>ADHESIVE NOTEPADS</b>							
	3518						
	<b>DG</b>	1,00	0,70	0,52	0,43	0,42	0,41
	 <b>3516</b>						
	<b>DG</b>	1,10	0,76	0,57	0,47	Ⓢ	Ⓢ
	3548						
	<b>DG</b>	1,26	1,07	0,85	0,70	0,69	0,68
	 <b>3546</b>						
	<b>DG</b>	1,39	1,18	0,94	0,77	Ⓢ	Ⓢ
	3578						
	<b>DG</b>	2,09	1,78	1,50	1,33	1,30	1,27
	 <b>3576</b>						
	<b>DG</b>	2,30	1,96	1,66	1,47	Ⓢ	Ⓢ

**Additional charges:** Coûts supplémentaires: / Cargos adicionales: / Aufpreise: / Costi aggiuntivi:

**Exact colour match on pad** 105€

**Prices include 4-colour process imprint.** Les prix incluent l'impression en quadrichromie / Los precios incluyen una impresión en cuatricromía / In den Preisen inbegriffen ist der Vierfarbdruck-Aufdruck / I prezzi includono la stampa con processo in quadricromia.

**Orders must be multiples of the minimum order quantity.** Les commandes doivent être un multiple de la quantité minimum indiquée / Los pedidos deben ser múltiplos de la cantidad mínima de pedido / Bestellungen müssen das Vielfache der Mindestbestellmenge / Gli ordini devono essere multipli della quantità minima.

**Additional charge for shrink-wrapped pack: 0,11€.** Coût additionnelle pour emballage sous film: 0,11€ / Coste adicional por el retractilado: 0,11€ / Aufpreis für eingeschweißte Einzel-Mehrverpackung 0,11€ / Supplemento per blister 0,11€.

Ⓢ Price under request. Prix sur demande / Precio bajo consulta / Preis auf Anfrage / Prezzi su richiesta

**External packaging:**

Emballage externe / Envasado exterior / Außenverpackung / Imballaggio esterno.



\*The percentage is calculated excluding backsheet.  
 \*Pourcentage calculé hors dernière page.  
 \*Porcentaje calculado excluyendo la última página.  
 \*Der Prozentsatz ist ohne Rückblatt kalkuliert  
 \*La percentuale è calcolata escludendo il cartoncino di fondo.

ecolutions® VERSION AVAILABLE

MADE WITH 100% FSC CERTIFIED PAPER  
& 100% RECYCLABLE



Large imprint area for big messages!  
Don't miss anything!

BIC® sticky notes • ADHESIVE NOTEPADS

130%

**Exact colour match:**

Correspondance exacte des couleurs / Color exacto / Exakte Farbübereinstimmung / Esatta corrispondenza di colore

**Paper type:**

Type de papier / Tipo de papel / Papierart / Tipo carta

**Special packaging:**

Emballage spécial / Envasado especial / Preis auf Anfrage / Confezione speciale.

**Printing techniques:**

Techniques d'impression / Técnicas de impresión / Drucktechniken / Tecniche di stampa.

≥ 500 units

- Standard 80g
- Recycled 80g

**shrink-wrapped**

N° Sheets	Units per pack
25	10
50	5
100	1



(DG)  
DIGITAL



MADE IN SPAIN







**ECOLUTIONS VERSION: MADE OF 100% RECYCLED FIBRE\* & 100% RECYCLABLE**  
**NON ECOLUTIONS VERSION: MADE WITH 100% FSC CERTIFIED PAPER & 100% RECYCLABLE**

**Decoration:**





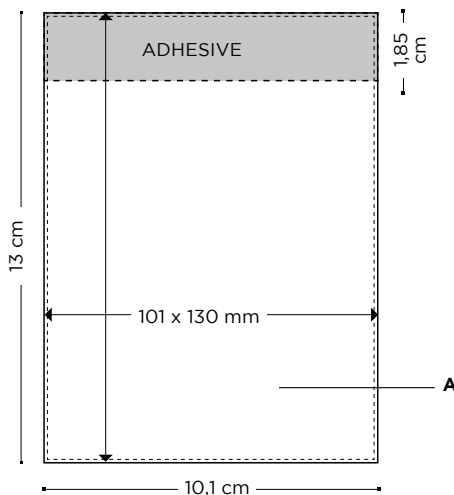

Personalisation / Personalización / Dekoration / Decorazione.

**BIC® 101 MM X 130 MM**      **MOQ 500u.**  
**ADHESIVE NOTEPADS**

**A DG:** 4-colour process

-  25  
 **3515**
-  50  
 **3545**
-  100  
 **3575**



		Price (€)					
		500-999	1000-2499	2500-4999	5000-9999	10000-24999	25000-49999
	<b>BIC® 101 MM X 130 MM</b>						
	<b>ADHESIVE NOTEPADS</b>						
	3517						
	<b>DG</b>	1,20	1,02	0,76	0,65	0,64	0,63
	 <b>3515</b>						
	<b>DG</b>	1,32	1,13	0,84	0,72	①	①
	3547						
	<b>DG</b>	1,65	1,37	1,20	1,02	1,00	0,98
	 <b>3545</b>						
	<b>DG</b>	1,82	1,51	1,33	1,12	①	①
	3577						
	<b>DG</b>	2,52	2,20	1,89	1,80	1,76	1,72
	 <b>3575</b>						
	<b>DG</b>	2,80	2,44	2,09	2,00	①	①

**Additional charges:** Coûts supplémentaires: / Cargos adicionales: / Aufpreise: / Costi aggiuntivi:

**Exact colour match** 105€

**Prices include 4-colour process imprint.** Les prix incluent l'impression en quadrichromie / Los precios incluyen una impresión en cuatricromía / In den Preisen inbegriffen ist der Vierfarbdruck-Aufdruck / I prezzi includono la stampa con processo in quadricromia.

**Orders must be multiples of the minimum order quantity.** Les commandes doivent être un multiple de la quantité minimum indiquée / Los pedidos deben ser múltiples de la cantidad mínima de pedido / Bestellungen müssen das Vielfache der Mindestbestellmenge / Gli ordini devono essere multipli della quantità minima.

**Additional charge for shrink-wrapped pack: 0,11€.** Coût additionnelle pour emballage sous film: 0,11€ / Coste adicional por el retráctilado: 0,11€ / Aufpreis für eingeschweißte Einzel-Mehrerpackung 0,11€ / Supplemento per blister 0,11€.

① Price under request. Prix sur demande / Precio bajo consulta / Preis auf Anfrage / Prezzi su richiesta

**External packaging:**

Emballage externe / Envasado exterior / Außenverpackung / Imballaggio esterno.



\*The percentage is calculated excluding backsheet.

\*Pourcentage calculé hors dernière page.

\*Porcentaje calculado excluyendo la última página.

\*Der Prozentsatz ist ohne Rückblatt kalkuliert

\*La percentuale è calcolata escludendo il cartoncino di fondo.



# 75 X 127 MM NON-ADHESIVE SCRATCH PAD

SCRATCH PADS, indispensable for lists and quick notes.

MADE WITH 100% FSC CERTIFIED PAPER  
& 100% RECYCLABLE

3760 / 3761



Indispensable  
scratch pad  
for lists  
and quick notes



MOQ 500u.

### Decoration:

Personalisation / Personalización  
/ Dekoration / Decorazione.

### BIC® 75 X 127 NON-ADHESIVE SCRATCH PAD

A DG: 4-colour process

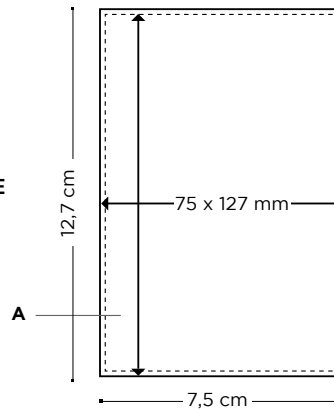

Price (€)

BIC® 75 X 127 NON-ADHESIVE SCRATCH PAD		500-999	1000-2499	2500-4999	5000-9999	10000-24999	25000-49999
20	DG	0,51	0,42	0,25	0,19	0,19	0,19
40	DG	0,76	0,59	0,38	0,34	0,33	0,32

**Additional charges:** Coûts supplémentaires: / Cargos adicionales: / Aufpreise: / Costi aggiuntivi:

**Exact colour match on pad** 105€

**Prices include 4-colour process imprint.** Les prix incluent l'impression en quadrichromie / Los precios incluyen una impresión en cuatricromía / In den Preisen inbegriffen ist der Vierfarbdruck-Aufdruck / I prezzi includono la stampa con processo in quadricromia.

**Orders must be multiples of the minimum order quantity.** Les commandes doivent être un multiple de la quantité minimum indiquée / Los pedidos deben ser múltiples de la cantidad mínima de pedido / Bestellungen müssen das Vielfache der Mindestbestellmenge / Gli ordini devono essere multipli della quantità minima.

**Additional charge for shrink-wrapped pack: 0,11€.** Coût additionnelle pour emballage sous film: 0,11€ / Coste adicional por el retractilado: 0,11€ / Aufpreis für eingeschweißte Einzel-Mehrverpackung 0,11€ / Supplemento per blister 0,11€.

### Paper type:

Type de papier / Tipo de papel / Papierart / Tipo carta.

Standard 60g

### Printing techniques:

Techniques d'impression / Técnicas de impresión / Drucktechniken / Tecniche di stampa.



(DG)  
DIGITAL

### External packaging:

Emballage externe / Envasado exterior / Außenverpackung / Imballaggio esterno.



400 ± 5,4 Kg



200 ± 5,2 Kg

Optional Packaging:  
Cello Wrap 1, 2, 3 units



MADE IN  
SPAIN



MADE WITH 100% FSC CERTIFIED PAPER  
& 100% RECYCLABLE

3762 / 3763



MOQ 500u.

**Decoration:**

Personnalisation / Personalización / Dekoration / Decorazione.

**BIC® 96 X 152 NON-ADHESIVE SCRATCH PAD**

**A DG:** 4-colour process

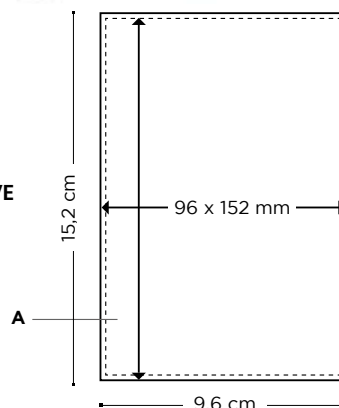

		Price (€)					
		500-999	1000-2499	2500-4999	5000-9999	10000-24999	25000-49999
20	<b>BIC® 96 X 152 NON-ADHESIVE SCRATCH PAD</b>						
	3762						
40	<b>DG</b>	0,63	0,52	0,30	0,24	0,24	0,24
	3763						
40	<b>DG</b>	0,96	0,76	0,48	0,43	0,42	0,41

**Additional charges:** Coûts supplémentaires: / Cargos adicionales: / Aufpreise: / Costi aggiuntivi:

**Exact colour match on pad** 105€

**Prices include 4-colour process imprint.** Les prix incluent l'impression en quadrichromie / Los precios incluyen una impresión en cuatricromía / In den Preisen inbegriffen ist der Vierfarbdruck-Aufdruck / I prezzi includono la stampa con processo in quadricromia.

**Orders must be multiples of the minimum order quantity.** Les commandes doivent être un multiple de la quantité minimum indiquée / Los pedidos deben ser múltiples de la cantidad mínima de pedido / Bestellungen müssen das Vielfache der Mindestbestellmenge / Gli ordini devono essere multipli della quantità minima.

**Additional charge for shrink-wrapped pack: 0,11€.** Coût additionnelle pour emballage sous film: 0,11€ / Coste adicional por el retractilado: 0,11€ / Aufpreis für eingeschweißte Einzel-Mehrverpackung 0,11€ / Supplemento per blister 0,11€.

**Paper type:**

Type de papier / Tipo de papel / Papierart / Tipo carta.

Standard 60g

**Printing techniques:**

Techniques d'impression / Técnicas de impresión / Drucktechniken / Tecniche di stampa.



(DG)  
DIGITAL

**External packaging:**

Emballage externe / Envasado exterior / Außenverpackung / Imballaggio esterno.



**350 ± 8,6 Kg**



**200 ± 8 Kg**

Optional Packaging:  
Cello Wrap 1, 2, 3 units



MADE IN SPAIN

The multi-purpose notes tool! Double the impact of your message with a fully personalised cover and Sticky Notes pad.

FR > Le multifunction pour la prise de notes ! Double impact de votre message grâce à la couverture personnalisée et au bloc-notes Sticky Notes.

DE > Das Multitool für Ihre Notizen! Doppelte Wirkung für Ihre Marke dank vollständig personalisierter Deckseite und Haftnotizenblock.

ES > ¡El bloc de notas multiuso! Doble impacto para tu mensaje gracias a la cubierta personalizada y a su bloc de notas Sticky Notes.

IT > Il blocchetto multi funzione! Un doppio impatto per il tuo messaggio con la copertina e il blocco Sticky Notes personalizzati.







120%

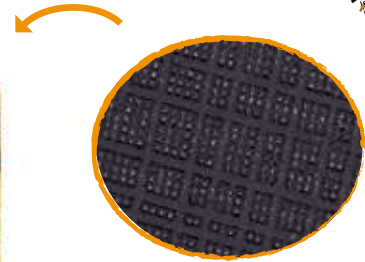

Choose a cover finish for your booklet: brilliant, pattern laminated or matt soft-feel laminated



25 flags of each colour!

**Special packaging:**

Emballage spécial / Envasado especial / Preis auf Anfrage / Confezione speciale.

Shrink-wrapped: 10 Booklets

**Printing techniques:**

Techniques d'impression / Técnicas de impresión / Drucktechniken / Tecniche di stampa.



(DG)  
DIGITAL



MADE IN SPAIN

**Decoration:**

Personnalisation / Personalización / Dekoration / Decorazione.

**BIC® FLAG BOOKLET      MOQ 250u.**

**A/B DG:** 4-colour process

 25 3730

 25 Flags per color

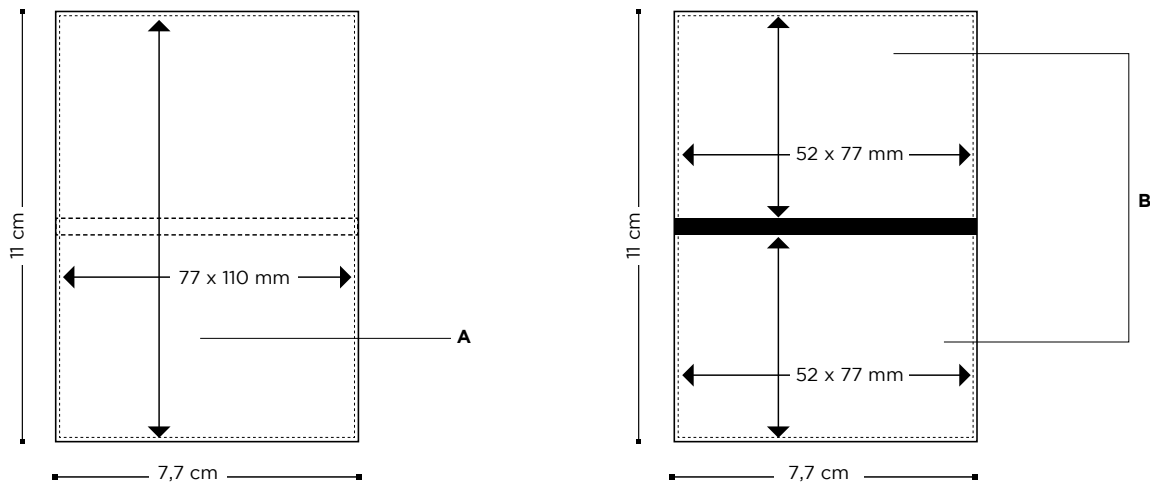

	Price (€)						
<b>BIC® FLAG BOOKLET</b>	250-499	500-999	1000-2499	2500-4999	5000-9999	10000-24999	25000-49999
3730							
<b>DG</b>	2,17	1,81	1,40	0,97	0,83	0,81	0,79

**Additional charges:** Coûts supplémentaires: / Cargos adicionales: / Aufpreise: / Costi aggiuntivi:

<b>Printing on Inside cover</b>	0,08	0,07	0,07	0,07	0,06	0,06	0,06
<b>Matt soft-feel/pattern laminated finish</b>	0,08	0,07	0,07	0,07	0,06	0,06	0,06

**Orders must be multiples of the minimum order quantity.** Les commandes doivent être un multiple de la quantité minimum indiquée / Los pedidos deben ser múltiplos de la cantidad mínima de pedido / Bestellungen müssen das Vielfache der Mindestbestellmenge / Gli ordini devono essere multipli della quantità minima.

BIC® Booklets: Prices include 4-colour process imprint only on the external part of the cover.

**Additional charge for shrink-wrapped pack: 0,11€.** Coût additionnelle pour emballage sous film: 0,11€ / Coste adicional por el retractilado: 0,11€ / Aufpreis für eingeschweißte Einzel-Mehrverpackung 0,11€ / Supplemento per blister 0,11€.

**External packaging:**

Emballage externe / Envasado exterior / Außenverpackung / Imballaggio esterno.



 25

**150 ± 1,56 Kg**

Optional Packaging:  
Cello Wrap 1, 2, 3 units

ADHESIVE SHEETS MADE WITH 100%  
FSC CERTIFIED PAPER & 100% RECYCLABLE



**Paper type:**

Type de papier / Tipo de papel / Papierart / Tipo carta.

Standard 80g

**Special packaging:**

Emballage spécial / Envasado especial / Preis auf Anfrage / Confezione speciale.

Shrink-wrapped: 10 Booklets

Optional Packaging:  
Cello Wrap 1, 2 units

**Printing techniques:**

Techniques d'impression / Técnicas de impresión / Drucktechniken / Tecniche di stampa.



(DG)  
DIGITAL



MADE IN  
SPAIN

**Decoration:**

Personnalisation / Personalización / Dekoration / Decorazione.

**BIC® 75 X 75 BOOKLET**

A/B/C/D DG: 4-colour process

MOQ with unimprinted pad: 250u.

MOQ with imprinted pad: 500u.

25 3731

50 3737

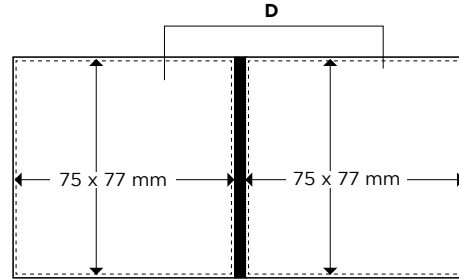
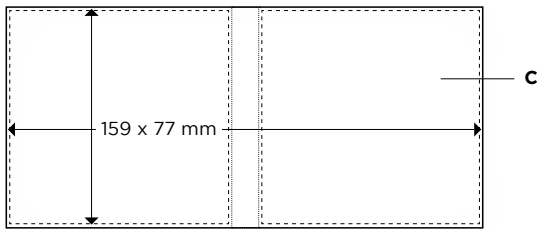
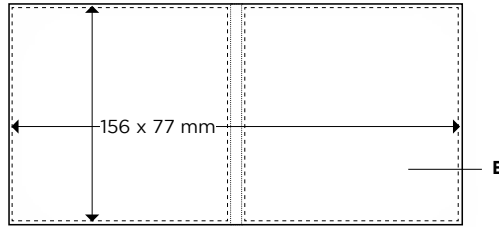
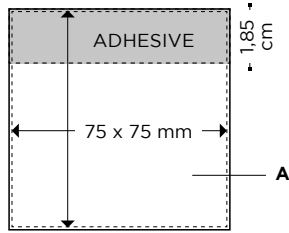

		Price (€)						
		250-499	500-999	1000-2499	2500-4999	5000-9999	10000-24999	25000-49999
25	<b>BIC® 75 X 75 BOOKLET</b>							
	3731*							
	<b>DG</b>	1,71	1,42	1,28	1,05	0,96	0,94	0,92
50	<b>BIC® 75 X 75 BOOKLET</b>							
	3737							
	<b>DG</b>	2,16	1,79	1,57	1,35	1,24	1,22	1,20

**Additional charges:** Coûts supplémentaires: / Cargos adicionales: / Aufpreise: / Costi aggiuntivi:

	105€						
<b>Exact colour match on pad</b>	105€						
<b>Printing on pad</b>	0,08	0,07	0,07	0,07	0,06	0,06	0,06
<b>Printing on inside cover</b>	0,08	0,07	0,07	0,07	0,06	0,06	0,06
<b>Matte soft-feel/pattern laminated finish</b>	0,08	0,07	0,07	0,07	0,06	0,06	0,06

**Orders must be multiples of the minimum order quantity.** Les commandes doivent être un multiple de la quantité minimum indiquée / Los pedidos deben ser múltiples de la cantidad mínima de pedido / Bestellungen müssen das Vielfache der Mindestbestellmenge / Gli ordini devono essere multipli della quantità minima.

**BIC® Booklets: Prices include 4-colour process imprint only on the external part of the cover.** Les prix incluent l'impression en quadrichromie seulement sur la couverture extérieure / Los precios incluyen impresión en cuatricromía sólo en el exterior de la cubierta / Preis inklusive Vierfarbdruck nur auf der Außenseite des Covers / I prezzi includono solo il processo di stampa in quadricromia sull'esterno della copertina.

**Additional charge for shrink-wrapped pack: 0,11€.** Coût additionnelle pour emballage sous film: 0,11€ / Coste adicional por el retractilado: 0,11€ / Aufpreis für eingeschweißte Einzel-Mehrverpackung 0,11€ / Supplemento per blister 0,11€.

\*<500 units only possible with unprinted BIC® Sticky Notes. Commandes inférieures à 500 unités disponibles seulement avec BIC® Sticky Notes sans impression / \* Pedidos inferiores a 500 unidades sólo disponibles con BIC® Sticky Notes sin impresión \* < 500 Stück nur mit unbedruckten BIC® Sticky Notes / \* <500 unità possibile solo con BIC® Sticky Notes senza stampa.

**External packaging:**

Emballage externe / Envasado exterior / Außenverpackung / Imballaggio esterno.



25

500 ± 7,8 Kg



50

250 ± 7,3 Kg



ADHESIVE SHEETS MADE WITH 100%  
FSC CERTIFIED PAPER & 100% RECYCLABLE



90%

Double the impact of your message with a fully personalised cover and sticky Notes pad in the most popular size

**Paper type:**

Type de papier / Tipo de papel / Papierart / Tipo carta

Standard 80g

**Special packaging:**

Emballage spécial / Envasado especial / Preis auf Anfrage / Confezione speciale.

Shrink-wrapped: 10 Booklets

Optional Packaging:  
Cello Wrap 1, 2, 3 units

**Printing techniques:**

Techniques d'impression / Técnicas de impresión / Drucktechniken / Tecniche di stampa.



(DG)  
DIGITAL



MADE IN SPAIN



**Decoration:**

Personnalisation / Personalización / Dekoration / Decorazione.

**BIC® 101 X 75 BOOKLET**

**E/F/G/H DG:** 4-colour process

📦 25 3738

📦 50 3739

**MOQ with unimprinted pad: 250u / MOQ with imprinted pad: 500u.**

**MOQ with imprinted pad: 250u.**

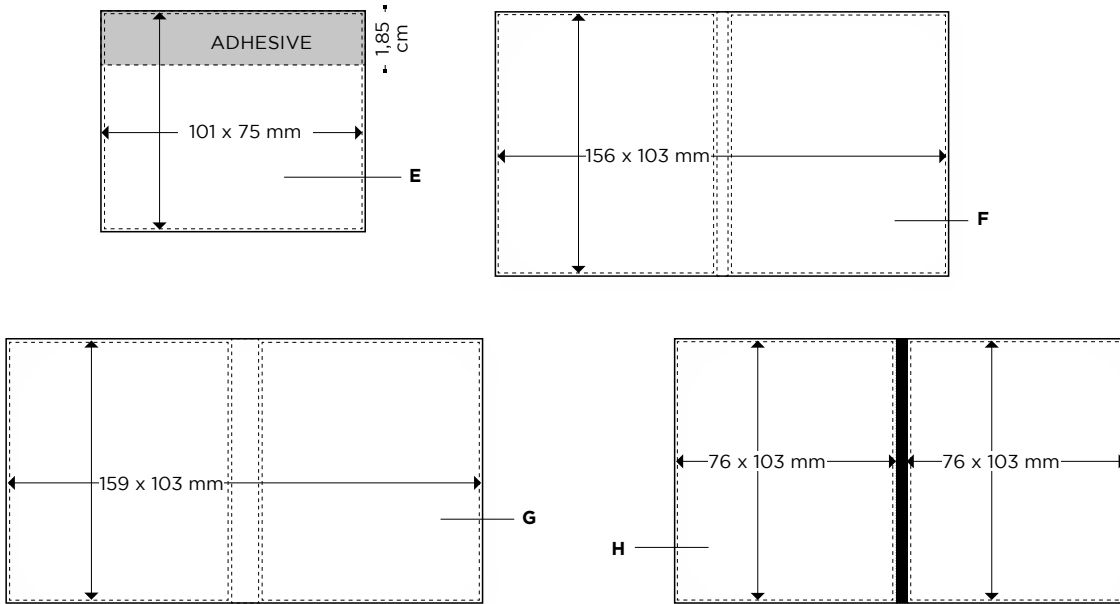

		Price (€)						
		250-499	500-999	1000-2499	2500-4999	5000-9999	10000-24999	25000-49999
📦 25	<b>BIC® 101 X 75 BOOKLET</b>							
	3738*							
📦 50	<b>DG</b>	1,96	1,63	1,43	1,22	1,12	1,10	1,08
	3739							
📦 50	<b>DG</b>	2,59	2,18	1,91	1,59	1,47	1,44	1,41

**Additional charges:** Coûts supplémentaires: / Cargos adicionales: / Aufpreise: / Costi aggiuntivi:

<b>Exact colour match on pad</b>	105€						
<b>Printing on pad</b>	0,08	0,07	0,07	0,07	0,06	0,06	0,06
<b>Printing on inside cover</b>	0,08	0,07	0,07	0,07	0,06	0,06	0,06
<b>Matte soft-feel/pattern laminated finish</b>	0,08	0,07	0,07	0,07	0,06	0,06	0,06

**Orders must be multiples of the minimum order quantity.** Les commandes doivent être un multiple de la quantité minimum indiquée / Los pedidos deben ser múltiples de la cantidad mínima de pedido / Bestellungen müssen das Vielfache der Mindestbestellmenge / Gli ordini devono essere multipli della quantità minima.

**BIC® Booklets: Prices include 4-colour process imprint only on the external part of the cover.** Les prix incluent l'impression en quadrichromie seulement sur la couverture extérieure / Los precios incluyen impresión en cuatricromía sólo en el exterior de la cubierta / Preis inklusive Vierfarbdruck nur auf der Außenseite des Covers / I prezzi includono solo il processo di stampa in quadricromia sull'esterno della copertina. **Additional charge for shrink-wrapped pack: 0,11€**

\*<500 units only possible with unprinted BIC® Sticky Notes. Commandes inférieures à 500 unités disponibles seulement avec BIC® Sticky Notes sans impression / \* Pedidos inferiores a 500 unidades sólo disponibles con BIC® Sticky Notes sin impresión \* < 500 Stück nur mit unbedruckten BIC® Sticky Notes / \* <500 unità possibile solo con BIC® Sticky Notes senza stampa.

**External packaging:**

Emballage externe / Envasado exterior / Außenverpackung / Imballaggio esterno.



📦 25

**500 ± 5,9 Kg**



📦 50

**250 ± 5,1 Kg**



# 75 X 75 ADHESIVE NOTEPAD WITH FLAG BOOKLET

ADHESIVE SHEETS MADE WITH 100%  
FSC CERTIFIED PAPER & **100% RECYCLABLE**



*The multi-purpose notes tool*

### Paper type:

Type de papier / Tipo de papel / Papierart / Tipo carta



Standard 80g

### Special packaging:

Emballage spécial / Envasado especial / Preis auf Anfrage / Confezione speciale.

Shrink-wrapped: 10 Booklets

Optional Packaging:  
Cello Wrap 1, 2, 3 units

### Printing techniques:

Techniques d'impression / Técnicas de impresión / Drucktechniken / Tecniche di stampa.



(DG)  
DIGITAL



MADE IN SPAIN

## Decoration:

Personnalisation / Personalización / Dekoration / Decorazione.

### BIC® ADHESIVE NOTEPAD WITH FLAG BOOKLET

MOQ with unimprinted pad: 250u.  
MOQ with imprinted pad: 500u.

A/B/C DG: 4-colour process

 25 3732

 25 Flags per color

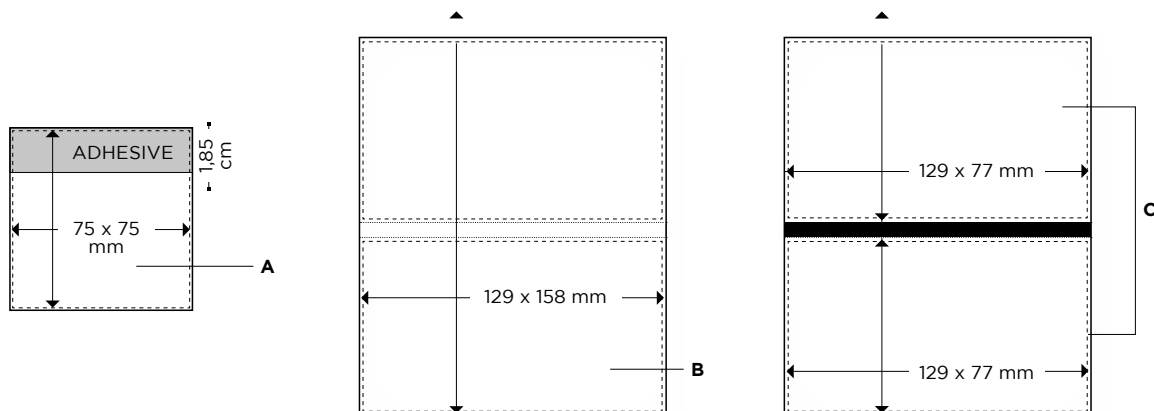

### BIC® ADHESIVE NOTEPADS WITH FLAG BOOKLET

3732\*

DG	250-499	500-999	1000-2499	2500-4999	5000-9999	10000-24999	25000-49999
	3,66	3,05	2,50	1,88	1,65	1,62	1,59

Price (€)

**Additional charges:** Coûts supplémentaires / Cargos adicionales / Aufpreise / Costi aggiuntivi:

<b>Exact colour match on pad</b>	105€						
<b>Printing on pad</b>	0,08	0,07	0,07	0,07	0,06	0,06	0,06
<b>Printing on inside cover</b>	0,08	0,07	0,07	0,07	0,06	0,06	0,06
<b>Matte soft-feel/pattern laminated finish</b>	0,08	0,07	0,07	0,07	0,06	0,06	0,06

**Orders must be multiples of the minimum order quantity.** Les commandes doivent être un multiple de la quantité minimum indiquée / Los pedidos deben ser múltiples de la cantidad mínima de pedido / Bestellungen müssen das Vielfache der Mindestbestellmenge / Gli ordini devono essere multipli della quantità minima.

**BIC® Booklets: Prices include 4-colour process imprint only on the external part of the cover.** Les prix incluent l'impression en quadrichromie seulement sur la couverture extérieure / Los precios incluyen impresión en cuatricromía sólo en el exterior de la cubierta / Preis inklusive Vierfarbdruck nur auf der Außenseite des Covers / I prezzi includono solo il processo di stampa in quadricromia sull'esterno della copertina.

**Additional charge for shrink-wrapped pack: 0,11€.** Coût additionnelle pour emballage sous film: 0,11€ / Coste adicional por el retractilado: 0,11€ / Aufpreis für eingeschweißte Einzel-Mehrverpackung 0,11€ / Supplemento per blister 0,11€.

\*<500 units only possible with unprinted BIC® Sticky Notes. Commandes inférieures à 500 unités disponibles seulement avec BIC® Sticky Notes sans impression / \* Pedidos inferiores a 500 unidades sólo disponibles con BIC® Sticky Notes sin impresión \* < 500 Stück nur mit unbedruckten BIC® Sticky Notes / \* <500 unità possibile solo con BIC® Sticky Notes senza stampa.

## External packaging:

Emballage externe / Envasado exterior / Außenverpackung / Imballaggio esterno.



 25

200 ± 5,2 Kg



# CLIC STIC MINI ORGANISER & BIC® CLIC STIC MINI DIGITAL ORGANISER

ADHESIVE SHEETS MADE WITH 100%  
FSC CERTIFIED PAPER & **100% RECYCLABLE**



## BIC® CLIC STIC MINI ORGANISER 3735



Use this all-in-one organiser  
for meeting and daily notes



This exceptional communication tool includes BIC® Clic Stic Mini Digital pen

**BIC® CLIC STIC MINI DIGITAL ORGANISER**  
3735



Photographic image all around!

- FR> Cet outil exceptionnel de communication inclut le BIC® Clic Stic Mini Digital pen
- ES> Esta comunicación excepcional incluye un bolígrafo BIC® Clic Stic Mini Digital
- DE> Dieses aussergewöhnliche Kommunikationsmittel beinhaltet den BIC® Clic Stic Mini Digital Kugelschreiber.
- IT> Questo eccezionale strumento di comunicazione include la penna BIC® Clic Stic Mini Digitale



Standard colours combination

Combinaison de couleurs standards / Combinación de colores estandar / Standardfarbkombination / Combinazione colori standard.



Plug

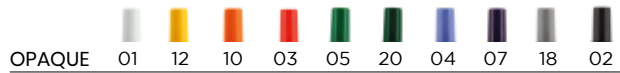
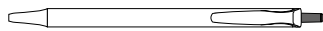

Clip

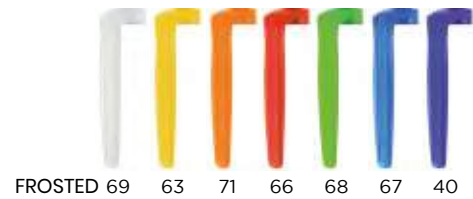
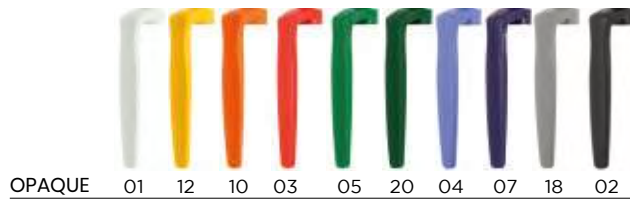
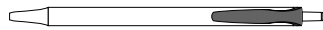

Section

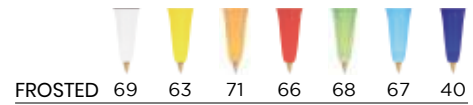
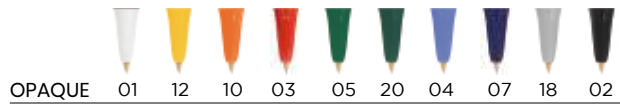
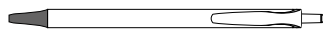

Barrel



Paper type:

Type de papier / Tipo de papel / Papierart / Tipo carta.

Standard 80g

Special packaging:

Emballage spécial / Envasado especial / Preis auf Anfrage / Confezione speciale.

Shrink-wrapped: 10 Booklets

Optional Packaging:

Cello Wrap 1, 2 units

Printing techniques:

Techniques d'impression / Técnicas de impresión / Drucktechniken / Tecniche di stampa.



(DG) DIGITAL



MADE IN SPAIN

**Decoration:**

Personnalisation / Personalización / Dekoration / Decorazione.

**MOQ with unimprinted pad: 250u.**  
**MOQ with imprinted pad: 500u.**

**BIC® CLIC STIC MINI ORGANISER & DIGITAL**

3735

**A/B/C DG:** 4-colour process.

**D/E SP:** max 1 colour

**F DG:** full-colour (area for text)  
 (available in white barrel)

**G DG:** full-colour (area for images)  
 (available in white barrel)

 20 Adhesive notepad

 40 Scratch pad

 25 Flags per color

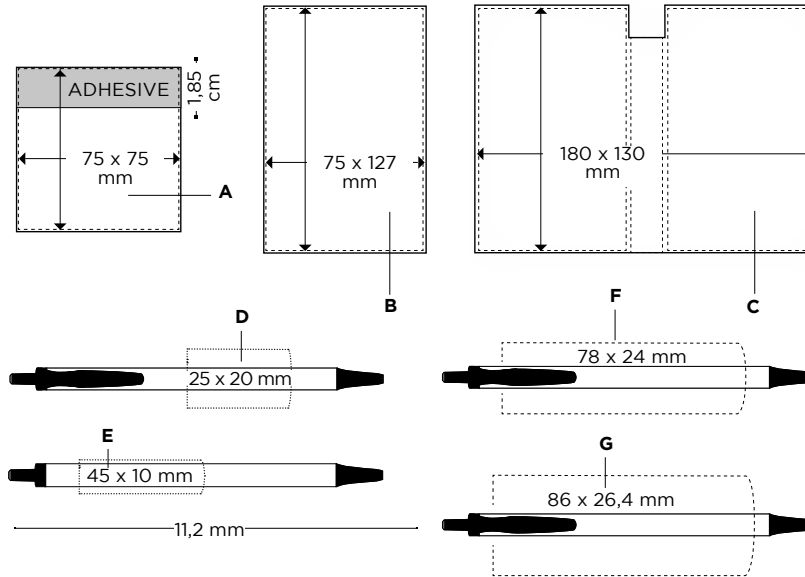

Price (€)

BIC® CLIC STIC MINI ORGANISER / MINI DIGITAL ORGANISER	250-499	500-999	1000-2499	2500-4999	5000-9999	10000-24999	25000-49999
DG/SP	5,21	4,33	3,93	3,48	3,23	①	①
DG/DG	5,60	4,65	4,21	3,72	3,49	①	①

**Additional charges:** Coûts supplémentaires / Cargos adicionales / Aufpreise / Costi aggiuntivi:

	250-499	500-999	1000-2499	2500-4999	5000-9999	10000-24999	25000-49999
<b>Exact colour match on pad</b>	105€						
<b>Printing on pad</b>	0,08	0,07	0,07	0,07	0,06	0,06	0,06
<b>Printing on inside cover</b>	0,08	0,07	0,07	0,07	0,06	0,06	0,06
<b>Matte soft-feel/pattern laminated finish</b>	0,08	0,07	0,07	0,07	0,06	0,06	0,06

**Orders must be multiples of the minimum order quantity.** Les commandes doivent être un multiple de la quantité minimum indiquée / Los pedidos deben ser múltiples de la cantidad mínima de pedido / Bestellungen müssen das Vielfache der Mindestbestellmenge / Gli ordini devono essere multipli della quantità minima.

**BIC® Booklets: Prices include 4-colour process imprint only on the external part of the cover.** Les prix incluent l'impression en quadrichromie seulement sur la couverture extérieure / Los precios incluyen impresión en cuatricromía sólo en el exterior de la cubierta / Preis inklusive Vierfarbdruck nur auf der Außenseite des Covers / I prezzi includono solo il processo di stampa in quadricromia sull'esterno della copertina.

**Additional charge for shrink-wrapped pack: 0,11€.** Coût additionnelle pour emballage sous film: 0,11€ / Coste adicional por el retractilado: 0,11€ / Aufpreis für eingeschweißte Einzel-Mehrverpackung 0,11€ / Supplemento per blister 0,11€.

① Price under request. Prix sur demande / Precio bajo consulta / Preis auf Anfrage / Prezzi su richiesta

**External packaging:**

Emballage externe / Envasado exterior / Außenverpackung / Imballaggio esterno.



125 ± 7 Kg

ADHESIVE SHEETS MADE WITH 100%  
FSC CERTIFIED PAPER & **100% RECYCLABLE**



*Create a unique notepad  
with this large format!*

**Paper type:**

Type de papier / Tipo  
de papel / Papierart /  
Tipo carta.

Standard 80g

**Special packaging:**

Emballage spécial / Envasado  
especial / Preis auf Anfrage /  
Confezione speciale.

Shrink-wrapped: 10 Booklets

**Printing techniques:**

Techniques d'impression / Técnicas de impresión  
/ Drucktechniken / Tecniche di stampa.



(DG)  
DIGITAL



MADE IN  
SPAIN



### Decoration:

Personnalisation / Personalización / Dekoration / Decorazione.

**BIC® 150 X 150  
BOOKLET ORGANISER**

**MOQ 500u.**

**A/B/C DG:** 4-colour process

 100 3745

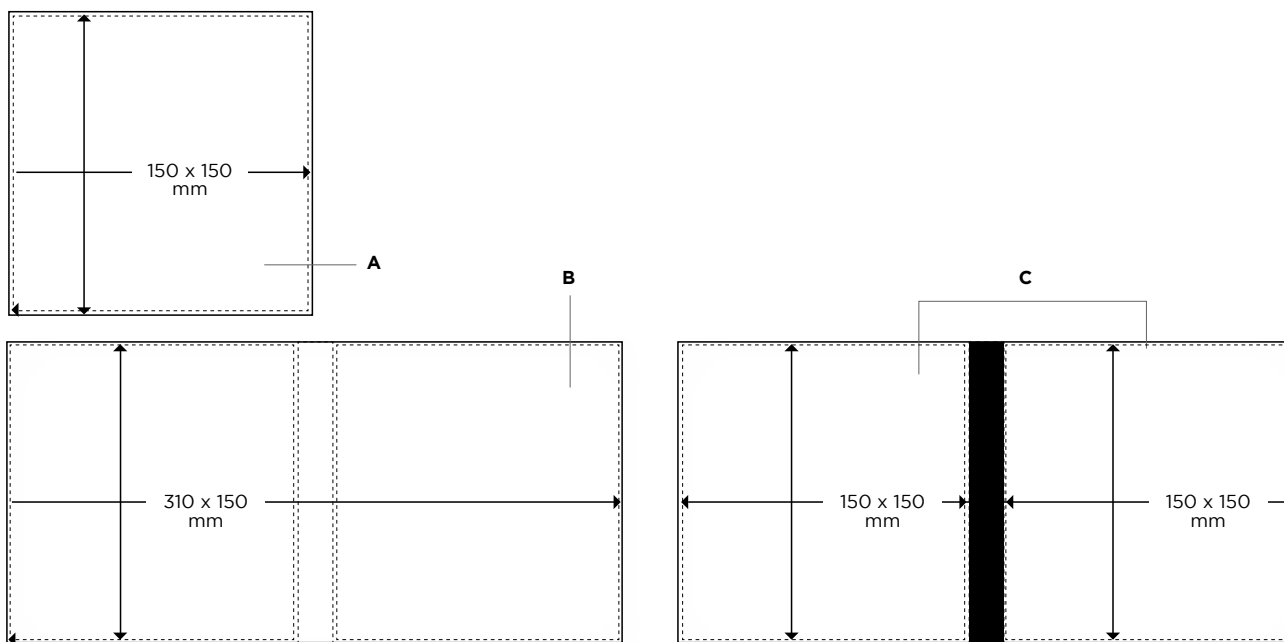

	Price (€)					
<b>BIC® 150 X 150 BOOKLET ORGANISER</b>	500-999	1000-2499	2500-4999	5000-9999	10000-24999	25000-49999
3745						
<b>DG</b>	5,10	4,74	4,25	3,96	①	①

**Additional charges:** Coûts supplémentaires / Cargos adicionales / Aufpreise / Costi aggiuntivi:

<b>Exact colour match on pad</b>	105€					
<b>Printing on pad</b>	0,07	0,07	0,07	0,06	0,06	0,06
<b>Printing on inside cover</b>	0,07	0,07	0,07	0,06	0,06	0,06
<b>Matte soft-feel/pattern laminated finish</b>	0,07	0,07	0,07	0,06	0,06	0,06

**Orders must be multiples of the minimum order quantity.** Les commandes doivent être un multiple de la quantité minimum indiquée / Los pedidos deben ser múltiples de la cantidad mínima de pedido / Bestellungen müssen das Vielfache der Mindestbestellmenge / Gli ordini devono essere multipli della quantità minima.

**BIC® Booklets: Prices include 4-colour process imprint only on the external part of the cover.** Les prix incluent l'impression en quadrichromie seulement sur la couverture extérieure / Los precios incluyen impresión en cuatricromía sólo en el exterior de la cubierta / Preis inklusive Vierfarbdruck nur auf der Außenseite des Covers / I prezzi includono solo il processo di stampa in quadricromia sull'esterno della copertina.

**Additional charge for shrink-wrapped pack: 0,11€.** Coût additionnelle pour emballage sous film: 0,11€ / Coste adicional por el retractilado: 0,11€ / Aufpreis für eingeschweißte Einzel-Mehrverpackung 0,11€ / Supplemento per blister 0,11€.

① Price under request. Prix sur demande / Precio bajo consulta / Preis auf Anfrage / Prezzi su richiesta

### External packaging:

Emballage externe / Envasado exterior / Außenverpackung / Imballaggio esterno.



**40 ± 6,4 Kg**



# 150 X 150 MM BOOKLET WITH PEN LOOP

ADHESIVE SHEETS MADE WITH 100%  
FSC CERTIFIED PAPER & 100% RECYCLABLE

3746



With Pen Loop

suggested presentation  
with BIC® Wide Body™ Digital.  
Combine this item with any  
of our writing products

BIC® sticky notes • BOOKLETS

	Price (€)					
BIC® 150 X 150 BOOKLET WITH PEN LOOP 3746	500-999	1000-2499	2500-4999	5000-9999	10000-24999	25000-49999
DG	6,07	5,66	5,04	4,72	①	①
Ballpen 1080						
DG	1,35	1,25	1,17	1,10	①	①

**Additional charges:** Coûts supplémentaires: / Cargos adicionales: / Aufpreise: / Costi aggiuntivi:

<b>Exact colour match on pad</b>	105€					
<b>Printing on pad</b>	0,07	0,07	0,07	0,06	0,06	0,06
<b>Printing on inside cover</b>	0,07	0,07	0,07	0,06	0,06	0,06
<b>Matte soft-feel/pattern laminated finish</b>	0,07	0,07	0,07	0,06	0,06	0,06

**Orders must be multiples of the minimum order quantity.** Les commandes doivent être un multiple de la quantité minimum indiquée / Los pedidos deben ser múltiples de la cantidad mínima de pedido / Bestellungen müssen das Vielfache der Mindestbestellmenge / Gli ordini devono essere multipli della quantità minima.

**BIC® Booklets: Prices include 4-colour process imprint only on the external part of the cover.** Les prix incluent l'impression en quadrichromie seulement sur la couverture extérieure / Los precios incluyen impresión en cuatricromía sólo en el exterior de la cubierta / Preis inklusive Vierfarbdruck nur auf der Außenseite des Covers / I prezzi includono solo il processo di stampa in quadricromia sull'esterno della copertina.

**Additional charge for shrink-wrapped pack: 0,11€.** Coût additionnelle pour emballage sous film: 0,11€ / Coste adicional por el retráctilado: 0,11€ / Aufpreis für eingeschweißte Einzel-Mehrpäckung 0,11€ / Supplemento per blister 0,11€. **Pen not included.** Stylo non inclus / Bolígrafo no incluido / Ohne Schreibgerät / Penna non inclusa.

① Price under request. Prix sur demande / Precio bajo consulta / Preis auf Anfrage / Prezzi su richiesta

## Paper type:

Type de papier / Tipo de papel / Papierart / Tipo carta.

Standard 80g

## Special packaging:

Emballage spécial / Envasado especial / Preis auf Anfrage / Confezione speciale.

Shrink-wrapped: 10 Booklets

Optional Packaging:  
Cello Wrap 1, 2, 3 units

## Printing techniques:

Techniques d'impression / Técnicas de impresión / Drucktechniken / Tecniche di stampa.



(DG)  
DIGITAL

## External packaging:

Emballage externe / Envasado exterior / Außenverpackung / Imballaggio esterno.



40 ± 6,7 Kg



MADE IN SPAIN

**Decoration:**

Personnalisation / Personalización / Dekoration / Decorazione.

**MOQ 500u.**

**BIC® 150 X 150 BOOKLET WITH PEN LOOP**

**A/B/C DG:** 4-colour process

**D/F SP:** max. 2 col.

**E/I SP:** max. 1 col.

**G DG:** full-colour (area for images)

**H DG:** full-colour (area for text)

100 3746

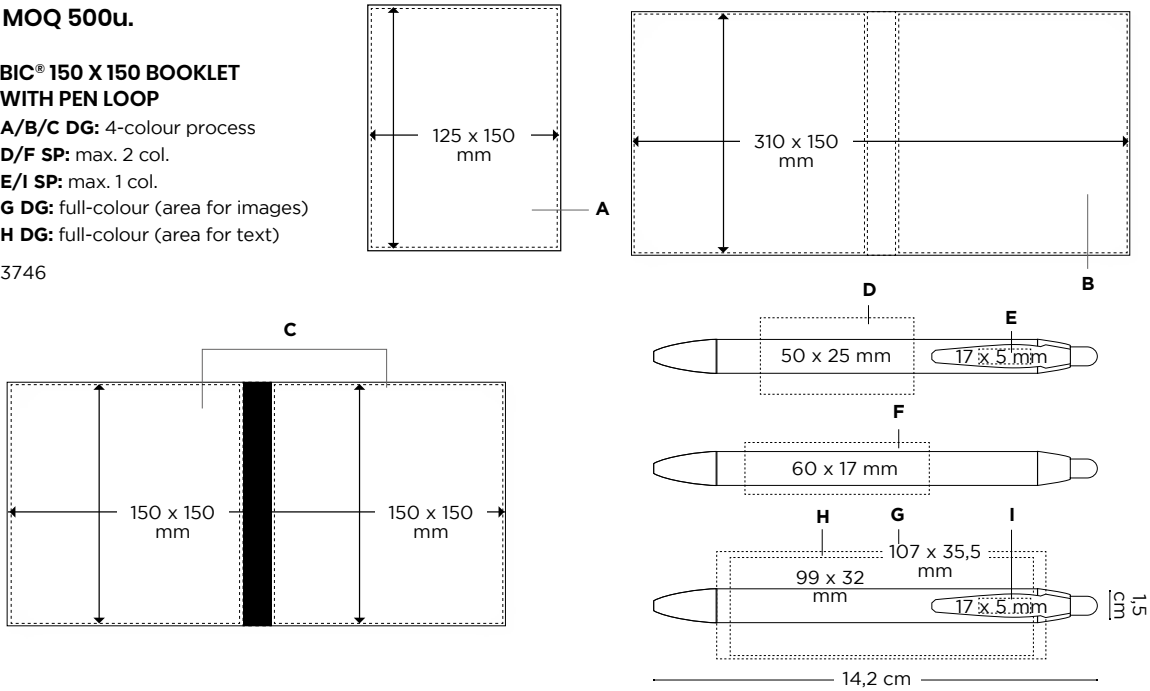

**Standard colours combination**

Combinaison de couleurs standards / Combinación de colores estandard / Standardfarbkombination / Combinazione colori standard



OPAQUE 01

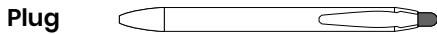

OPAQUE 01 03 07 18 02



FROSTED 69 63 71 66 68 67 40



OPAQUE 01 03 07 18 02

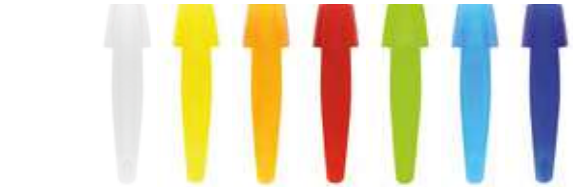

FROSTED 69 63 71 66 68 67 40



OPAQUE 01 03 07 18 02



FROSTED 69 63 71 66 68 67 40

**PU COVER NOTEBOOKS**

**229** BIC® Notebooks Dual A5

**232** BIC® Notebooks Dual A6



# Notebooks

226 — 233

Stand out from the crowd with this personalisable notebook! Create the product you need for each event by combining the PU cover colour with the stack of paper inside. The integrated pen loop in the spine is a practical way to always take your BIC® ballpen with you.

FR > Démarquez-vous de la concurrence grâce à ce carnet de notes personnalisable et signé BIC® ! Créez le produit dont vous avez besoin pour chaque événement en combinant la couleur de la couverture en PU et celle des feuilles à l'intérieur. Le porte-stylo intégré est pratique pour avoir toujours votre stylo-bille BIC® avec vous.

DE > Seien Sie anders als alle anderen mit diesem personalisierbaren Notizbuch! Kreieren Sie für jede Veranstaltung das Produkt, das Sie brauchen, indem Sie die Farbe des PU-Einbands mit dem Papier im Notizbuch kombinieren. Mit dem praktischen integrierten Kugelschreiberhalter am Rücken können Sie Ihren BIC®-Kugelschreiber immer dabei haben.

ES > ¡Destaca entre la multitud con esta libreta personalizable! Crea el producto que necesitas para cada evento combinando la cubierta de color en PU con el bloc de notas de papel en el interior. El soporte para el bolígrafo intergrado en el lomo es la manera más práctica de llevar tu bolígrafo BIC® contigo.

IT > Fatti notare con questo blocco note personalizzabile! Crea il prodotto di cui hai bisogno per ogni evento combinando il colore della copertina in PU con la carta al suo interno. L'asola per penna incorporata nel dorso è un modo pratico per portare la tua penna a sfera BIC® sempre con te.



Cover - 3721(A5)/3725(A6)

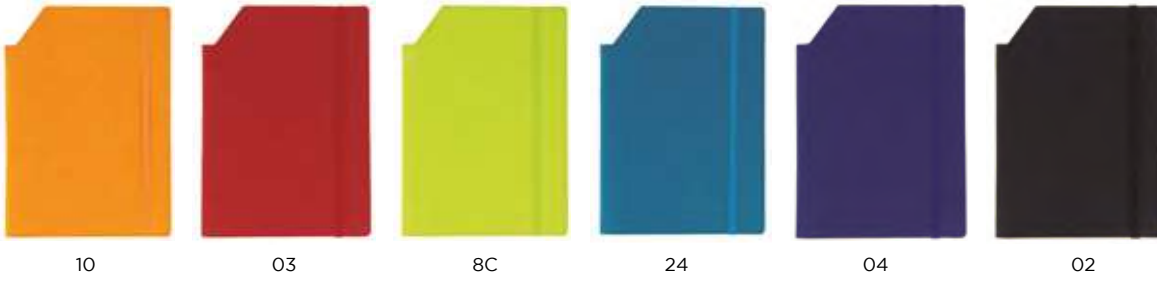

**MIX & MATCH**

Inner notepad - 3724(A5)/3712(A6)



*Create your own combination,  
choose a cover and notepad colour!*



**MOQ 50u.**

**Standard colours combination**

Combinaison de couleurs standards / Combinación de colores estandard / Standardfarbkombination / Combinazione colori standard



**Cover**

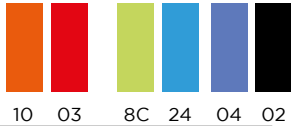

**Inner notepad**

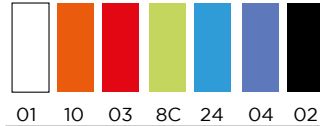

*Create your own combination, choose a cover and notepad colour!*

**Decoration:**

Personnalisation / Personalización / Dekoration / Decorazione.

**BIC® NOTEBOOKS DUAL A5**

Cover 3721

**A SP:** max. 1 col.

**B DB/HS:** transparent foil.

**C SP:** full cover max 1 col.

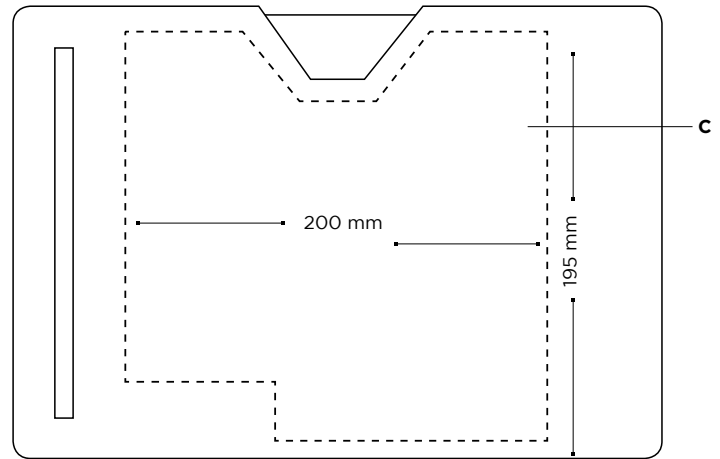
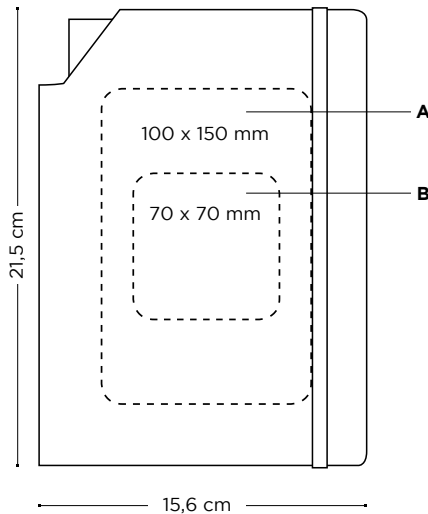

	Price (€)						
<b>BIC® Notebooks Dual A5</b>	50-99	100-249	250-499	500-999	1000-2499	2500-4999	5000-9999
Cover 3721							
<b>SP</b>	9,98	9,28	8,83	8,49	8,15	①	①
<b>SP full cover</b>	11,19	10,29	9,75	9,32	8,89	①	①
<b>DB/HS</b>	10,86	10,08	9,60	9,23	8,86	①	①

**Prices include one imprint in one position according to specified technique.** Les prix incluent une impression sur un emplacement avec la technique spécifiée / Los precios incluyen una impresión en una posición acorde con la técnica especificada / In den Preisen inbegriffen ist ein Aufdruck auf einer Position gemäß angegebener Technik / I prezzi includono una stampa in una posizione a seconda della tecnica specificata.

	Price (€)						
	50-99	100-249	250-499	500-999	1000-2499	2500-4999	5000-9999
Add a BIC® ballpen to your BIC® Notebook							



<b>BIC® Media Clic</b>	2,86	1,78	0,93	0,60	0,56	①	①
<b>BIC® Super Clip</b>	3,47	2,02	1,03	0,98	0,94	①	①
<b>BIC® 4 Colours</b>	4,54	3,67	2,97	2,69	2,49	2,33	①

**Prices include 1 colour screenprint in one position.** Les prix incluent la sérigraphie 1 couleur sur un emplacement / En precio incluye un color en serigrafía en una posición / In den Preisen inbegriffen ist 1 Siebdruck-Farbaufdruck auf 1 Position / I prezzi includono la serigrafia ad 1 colore in una posizione.

① Price under request. Prix sur demande / Precio bajo consulta / Preis auf Anfrage / Prezzi su richiesta.

**Paper type:**

Type de papier / Tipo de papel / Papierart / Tipo carta

- 80  Standard 80g
- 80  Standard 80g

**Printing techniques:**

Techniques d'impression / Técnicas de impresión / Drucktechniken / Tecniche di stampa.



(SP) SCREEN PRINTING



(DB) DEBOSSING (HS) HOT STAMPING

**External packaging:**

Emballage externe / Envasado exterior / Außenverpackung / Imballaggio esterno.



**35 ± 8,6 Kg**

**New optional special packaging:**

Nouvel emballage spécial en option / Nuevo envasado especial opcional / Neue optionale Verpackung / Nuove confezioni speciali opzionali



Gift Box A5 (Notebook + Ballpen) + INFO pag. 307



## BIC® NOTEBOOKS DUAL A5 INNER NOTEPAD

MOQ 50u.

Use the inner notepad to refill your Dual Cover, or as a notebook itself!

### Decoration:

Personnalisation / Personalización / Dekoration / Decorazione.

Inner notepad 3724

**D SP:** max. 1 col.

**E DB/HS:** max. 1 col.

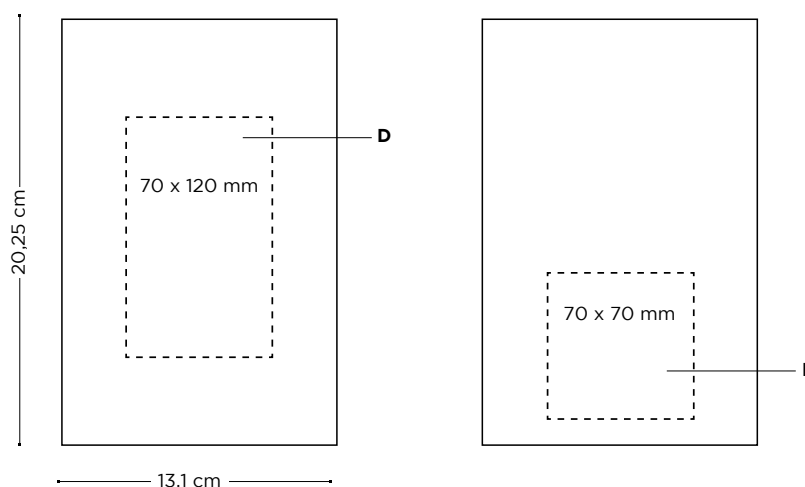

	Price (€)						
BIC® Notebooks Dual A5	50-99	100-249	250-499	500-999	1000-2499	2500-4999	5000-9999
Inner notepad 3724							
<b>SP</b>	5,43	5,03	4,79	4,61	4,42	①	①
<b>DB/HS</b>	6,33	5,87	5,60	5,39	5,17	①	①

**Prices include one imprint in one position according to specified technique.** Les prix incluent une impression sur un emplacement avec la technique spécifiée / Los precios incluyen una impresión en una posición acorde con la técnica especificada / In den Preisen inbegriffen ist ein Aufdruck auf einer Position gemäß angegebener Technik / I prezzi includono una stampa in una posizione a seconda della tecnica specificata.

① Price under request. Prix sur demande / Precio bajo consulta / Preis auf Anfrage / Prezzi su richiesta.

### Paper type:

Type de papier / Tipo de papel / Papierart / Tipo carta.

- 80  Standard 80g  
80  Standard 80g

### Printing techniques:

Techniques d'impression / Técnicas de impresión / Drucktechniken / Tecniche di stampa.



(SP) SCREEN PRINTING



(DB) DEBOSSING



(HS) HOT STAMPING

### External packaging:

Emballage externe / Envasado exterior / Außenverpackung / Imballaggio esterno.



55 ± 10,7 Kg

**MOQ 50u.**

**Standard colours combination**

Combinaison de couleurs standards / Combinación de colores estandar / Standardfarbcombination / Combinazione colori standard.

**Cover**

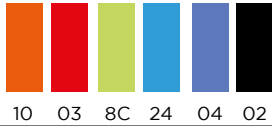

**Inner notepad**

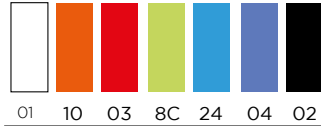

*Create your own combination, choose a cover and notepad colour!*

**Decoration:**

Personnalisation / Personalización / Dekoration / Decorazione.

**BIC® NOTEBOOKS DUAL A6**

Cover 3725

**A SP:** max. 1 col.

**B DB/HS:** transparent foil.

**C SP:** full cover max 1 col.

*New!*

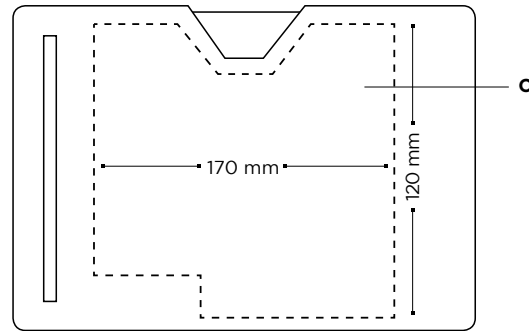
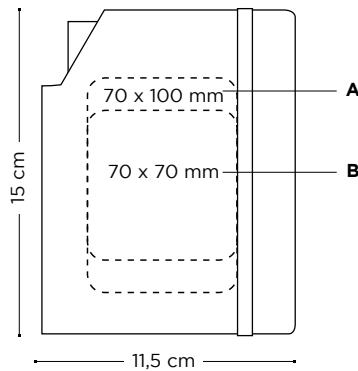

*New imprint area*

BIC® Notebooks Dual A6	50-99	100-249	250-499	500-999	1000-2499	2500-4999	5000-9999
Cover 3725							
<b>SP</b>	7,34	6,81	6,48	6,23	5,98	①	①
<b>SP full cover</b>	8,53	7,82	7,40	7,06	6,72	①	①
<b>DB/HS</b>	8,20	7,61	7,25	6,97	6,69	①	①

**Prices include one imprint in one position according to specified technique.** Les prix incluent une impression sur un emplacement avec la technique spécifiée / Los precios incluyen una impresión en una posición acorde con la técnica especificada / In den Preisen inbegriffen ist ein Aufdruck auf einer Position gemäß angegebener Technik / I prezzi includono una stampa in una posizione a seconda della tecnica specificata.

	50-99	100-249	250-499	500-999	1000-2499	2500-4999	5000-9999
Add a BIC® ballpen to your BIC® Notebook							



<b>BIC® Media Clic</b>	2,86	1,78	0,93	0,60	0,56	①	①
<b>BIC® Super Clip</b>	3,47	2,02	1,03	0,98	0,94	①	①
<b>BIC® 4 Colours</b>	4,54	3,67	2,97	2,69	2,49	2,33	①

**Prices include 1 colour screenprint in one position.** Les prix incluent la sérigraphie 1 couleur sur un emplacement / En precio incluye un color en serigrafía en una posición / In den Preisen inbegriffen ist 1 Siebdruck-Farbaufdruck auf 1 Position / I prezzi includono la serigrafia ad 1 colore in una posizione.

① Price under request. Prix sur demande / Precio bajo consulta / Preis auf Anfrage / Prezzi su richiesta.

**Paper type:**

Type de papier / Tipo de papel / Papierart / Tipo carta

- 60  Standard 80g
- 60  Standard 80g

**Printing techniques:**

Techniques d'impression / Técnicas de impresión / Drucktechniken / Tecniche di stampa.



(SP) SCREEN PRINTING



(DB) DEBOSSING (HS) HOT STAMPING

**External packaging:**

Emballage externe / Envasado exterior / Außenverpackung / Imballaggio esterno.



**50 ± 6 Kg**

**New optional special packaging:**

Nouvel emballage spécial en option / Nuevo envasado especial opcional / Neue optionale Verpackung / Nuove confezioni speciali opzionali



Gift Box A6 (Notebook + Ballpen) + INFO pag. 307

## BIC® NOTEBOOKS DUAL A6 INNER NOTEPAD

MOQ 50u.

Use the inner notepad to refill your Dual Cover, or as a notebook itself!

### Decoration:

Personnalisation / Personalización / Dekoration / Decorazione.

Inner notepad 3712

**D SP:** max. 1 col.

**E DB/HS:** max. 1 col.

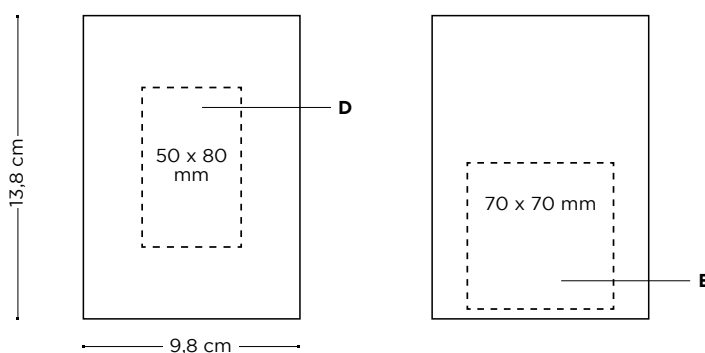

	Price (€)						
BIC® Notebooks Dual A6	50-99	100-249	250-499	500-999	1000-2499	2500-4999	5000-9999
Inner notepad 3712							
<b>SP</b>	3,82	3,54	3,37	3,24	3,11	①	①
<b>DB/HS</b>	4,68	4,34	4,14	3,98	3,82	①	①

**Prices include one imprint in one position according to specified technique.** Les prix incluent une impression sur un emplacement avec la technique spécifiée / Los precios incluyen una impresión en una posición acorde con la técnica especificada / In den Preisen inbegriffen ist ein Aufdruck auf einer Position gemäß angegebener Technik / I prezzi includono una stampa in una posizione a seconda della tecnica specificata.

① Price under request. Prix sur demande / Precio bajo consulta / Preis auf Anfrage / Prezzi su richiesta.

### Paper type:

Type de papier / Tipo de papel / Papierart / Tipo carta

- 60  Standard 80g
- 60  Standard 80g

### Printing techniques:

Techniques d'impression / Técnicas de impresión / Drucktechniken / Tecniche di stampa.



(SP) SCREEN PRINTING



(DB) DEBOSSING



(HS) HOT STAMPING

### External packaging:

Emballage externe / Envasado exterior / Außenverpackung / Imballaggio esterno.



140 ± 11,4 Kg

#### **LIGHTERS**

- 242** BIC® J25 Lighter
- 246** BIC® J23 Lighter
- 250** BIC® J26 Lighter
- 254** BIC® J38 Lighter
- 258** BIC® J39 Lighter
- 262** BIC® Mega Lighter

#### **LIGHTER CASES**

- 264** BIC® Stylit Luxury Case
- 266** BIC® Aluminium Flat Case
- 267** BIC® Clip Case
- 268** BIC® 3D Case

#### **OTHER PRODUCTS**

- 269** BIC® Pocket Ashtray



# Lighters

234 — 269

**FR> La sécurité, notre priorité**  
**BIC® : LE N° 1 MONDIAL EN BRIQUETS DE MARQUE**

**FLAMME STABLE**

Grâce au combustible pur d'isobutane

**CAPUCHON DE SÉCURITÉ**

Fabriqué en acier résistant avec verrouillage de sécurité

**HAUTE RÉSISTANCE**

Réservoir fabriqué avec une résine technique (Delrin®) à haute résistance mécanique

**SÉCURITÉ ENFANTS\***

Conforme à la norme EN 13869

**BRIQUET LONGUE DURÉE**

Grâce au plus grand volume de gaz dans le réservoir:  
JUSQU'À 3 000 ALLUMAGES

**BRIQUETS BIC®.**

**NOTRE QUALITÉ. VOTRE SÉCURITÉ**

\* Un briquet "sécurité enfants" n'est pas un briquet exempt de tout risque pour les enfants: c'est un briquet que 85% au moins des enfants de moins de 51 mois ne peuvent pas faire fonctionner, ce qui implique que la proportion des enfants en cause capables de l'actionner peut aller jusqu'à 15%. Les adultes doivent donc toujours veiller à ce que les briquets soient hors de portée des enfants, même s'il s'agit de briquets « sécurité enfants ».

**ES> La seguridad, nuestra prioridad**  
**BIC®: LA MARCA N°1 EN TODO EL MUNDO EN ENCENDEDORES DE BOLSILLO**

**LLAMA ESTABLE**

Gracias al combustible puro de isobutano

**CAPUCHÓN DE SEGURIDAD**

Hecho de acero resistente con función de bloqueo

**ALTA RESISTENCIA**

Depósito hecho de resina de alta resistencia mecánica (Delrin®)

**PROTECCIÓN A PRUEBA DE NIÑOS\***

Cumple con la normativa EN 13869

**ENCENDEDOR DE LARGA DURACIÓN**

Gracias al gran volumen de gas en su depósito: HASTA 3.000 ENCENDIDOS

**ENCENDEDORES BIC®.**

**NUESTRA CALIDAD, TU SEGURIDAD**

\* No es lo mismo un encendedor con seguridad para niños que un encendedor a prueba de niños. Por "encendedor con seguridad para niños" se entiende un encendedor que para un mínimo del 85% de los niños de hasta 51 meses de edad resulta imposible de accionar. Esto significa que hasta un 15% de los niños sí podrían hacer funcionar el encendedor. De ahí que los adultos deban siempre impedir que los niños jueguen con encendedores, por seguros que éstos sean.

**DE> Die Sicherheit, unsere Priorität**  
**BIC®: WELTWEIT DIE NR.1 UNTER DEN MARKEN-FEUERZEUGEN**

**STABILE FLAMME**

Dank des reinen Isobutan-Brennstoffs

**SICHERHEITSKAPPE**

Aus widerstandsfähigem Stahl mit Sperrfunktion

**BRUCHFEST**

Behälter aus äußerst stoßfestem technischem Thermoplast (Delrin®)

**KINDERSICHERUNG\***

Erfüllt die Vorschrift  
EN 13869

**LANGLEBIGES FEUERZEUG**

Dank des größeren Gasvolumens im Behälter: BIS ZU 3000 ZÜNDUNGEN

**BIC®-FEUERZEUGE. UNSERE QUALITÄT. IHRE SICHERHEIT**

\* Ein kindergesichertes Feuerzeug ist nicht unbedingt kindersicher. Als "kindergesichert" bezeichnet man Feuerzeuge, die von mindestens 85% der Kinder unter 51 Monaten nicht bedient werden können. Das bedeutet, dass bis zu 15% der Kinder diese Feuerzeuge möglicherweise bedienen können. Daher müssen Sie Feuerzeuge – auch wenn sie kindergesichert sind – stets außerhalb der Reichweite von Kleinkindern aufbewahren.

**IT> La sicurezza, la nostra priorità**  
**BIC®: IL N° 1 MONDIALE PER GLI ACCENDINI TASCABILI DI MARCA**

**FIAMMA STABILE**

Grazie all'isobutano puro

**CAPPUCCIO DI SICUREZZA**

Realizzato in acciaio resistente e con funzione di blocco

**OTTIMA RESISTENZA**

Serbatoio realizzato in resina ad alta resistenza meccanica (Delrin®)

**DISPOSITIVO DI SICUREZZA PER BAMBINI\***

Conforme allo standard  
EN 13869

**UN ACCENDINO DI LUNGA DURATA**

Grazie a un maggior volume di gas nel serbatoio. FINO A 3000 ACCENSIONI

**ACCENDINI BIC®**

**LA NOSTRA QUALITÀ, LA TUA SICUREZZA**

\* Un accendino dotato di dispositivo di sicurezza per i bambini non è un accendino a prova di bambino. Infatti, un accendino sicuro per i bambini è un accendino che almeno l'85% dei bambini di età inferiore a 51 mesi non è in grado di far funzionare. Ciò significa però che ben il 15% dei bambini potrebbe essere capace di azionare questo tipo di accendini. Per tale motivo, gli adulti dovrebbero sempre fare in modo che i bambini non possano impadronirsi di accendini, nemmeno qualora siano dotati di un dispositivo di sicurezza per i bambini.

**SAFETY, OUR PRIORITY**

**STABLE FLAME**

Thanks to pure isobutane



**SAFETY HOOD**

Made of strong steel material with locking feature



**HIGH RESISTANCE**

Reservoir made of high mechanical resistance resin (Delrin®)



**BIC** J26 LIGHTER

**CHILD-RESISTANT SAFETY GUARD\***

Compliant with EN 13869 Standard

\*A Child-resistant lighter is not a child proof lighter. A Child-resistant lighter is a lighter that at least 85% of children under 51 months of age cannot operate. This means that up to 15% of children may still be able to operate such a lighter. Therefore, adults should always ensure that young children cannot get hold of lighters, even if they are Child-resistant.



**A LONG LASTING LIGHTER**

Thanks to a greater volume of gas in the reservoir **UP TO 3000 LIGHTS**



**THE N°1**  
**WORLDWIDE**  
 IN BRANDED  
 POCKET  
 LIGHTERS

**BIC® LIGHTERS**  
 OUR QUALITY, YOUR SAFETY

**BIC** MEGA LIGHTER



70%

Up to 750

**BIC** J26 DIGITAL LIGHTER

**BIC** J38 DIGITAL LIGHTER

**BIC** J23 DIGITAL LIGHTER

**BIC** J25 DIGITAL LIGHTER



70%

Up to 1400



70%

Up to 1800



70%

Up to 3000



70%

Up to 1800

**BIC** J39 DIGITAL LIGHTER



70%

Up to 1050

---

**FR>** Finitions numériques et textures des briquets BIC®

**Digital Brilliant / Digital matt**

Brillante ou mate ? Choisissez la finition qui vous plaît !

**Metallic**

Créez de superbes effets ! Effets métalliques sur les textes, els images et le fond.

**Holographic gold / Holographic silver**

Démarquez-vous de la concurrence ! Jouez avec de jolis reflets légers de couleurs en utilisant la finition holographique.

**Puffy printing**

Faites preuve d'originalité ! Faites ressortir votre marque grâce à notre encre « puffy » et donnez ainsi du relief à votre logo.

**UV printing**

Faites ressortir votre marque avec une finition très brillante!  
Combinez les finitions mates et brillantes pour souligner les contrastes et faire ressortir le motif sur fond mat.

**Sandy**

Créez un effet « papier de verre » grâce à une surface granuleuse.

**Puffy Glitter**

Admirez et touchez la texture colorée à paillettes !

**Glow in the dark**

Faites briller votre marque, même dans le noir !

**ES>** Nuestros acabados digitales y texturas en los encendedores BIC®

**Digital Brilliant / Digital matt**

¿Brillante o mate? ¡Escoge el acabado que más te guste!

**Metallic**

¡Crea magníficos efectos! Efectos metálicos en los textos, imágenes y fondos.

**Holographic gold / Holographic silver**

¡Destaca entre la multitud! Juega con atractivos reflejos de luz con el acabado holográfico.

**Puffy printing**

¡Sé original! Destaca tu marca con nuestra tinta "puffy" para dar efecto relieve a tu logo.

**UV printing**

¡Destaca tu marca con el acabado de relieve brillante!  
Combina mate y brillante para resaltar contrastes y destacar prominentemente en fondo mate.

**Sandy**

Crea un efecto arena con una textura granulada.

**Puffy Glitter**

Mira y siente la textura brillante coloreada!

**Glow in the dark**

¡Haz que tu logo brille incluso en la oscuridad!

---

**DE>** Unsere digitalen Oberflächen & Texturen bei BIC®-Feuerzeugen

**Digital Brilliant / Digital Matt**

Glänzend oder matt?  
Wählen Sie die Oberfläche, die Ihnen gefällt!

**Metallic**

Kreieren Sie großartige Effekte! Metalliceffekte bei Texten, Bildern und Hintergründen

**Holographic Gold / Holographic Silver**

Heben Sie sich von der Masse ab! Spielen Sie mit den attraktiven Lichtreflexen der holographischen Oberfläche.

**Puffy Printing**

Seien Sie originell! Heben Sie Ihre Marke hervor mit unserer "Puffy"-Tinte und verleihen Sie Ihrem Logo einen Reliefeffekt.

**UV Printing**

Heben Sie Ihre Marke mit einer Hochglanzoberfläche heraus!  
Kombinieren Sie matte & glänzende Oberflächen, um Kontraste zu betonen und prominent auf mattem Untergrund hervorzutreten

**Sandy**

Kreieren Sie einen Sandpapier-Effekt mit körniger Struktur.

**Puffy Glitter**

Fühlen und sehen Sie die farbige Glitzer-Struktur!

**Glow in the dark**

Lassen Sie Ihre Marke selbst in der Dunkelheit aufleuchten!

**IT>** Le nostre finiture digitali e le texture degli accendini BIC®

**Digital Brilliant / Digital matt**

Brillante o opaco? Scegli la finitura che preferisci!

**Metallic**

Crea effetti incredibili! Effetti metallici su testi, immagini e sfondi.

**Holographic gold / Holographic silver**

Fatti notare! Gioca con gli attraenti riflessi di luce della finitura oleografica.

**Puffy printing**

Sii originale! Metti in evidenza il tuo marchio con il nostro inchiostro "puffy" per dare un effetto rilievo al tuo logo.

**UV printing**

Metti in evidenza il tuo marchio con una finitura ultra lucida !  
Combina una finitura opaca con una lucida per creare contrasti e dare risalto su uno sfondo opaco.

**Sandy**

Crea un effetto carta vetrata con una texture granulata.

**Puffy Glitter**

La texture in glitter colorati è tutta da vedere e sentire!

**Glow in the dark**

Fai brillare il tuo marchio al buio!





**DIGITAL BRILLIANT  
DIGITAL MATT**

**Brilliant or matt?**

Choose the finish you like!



**METALLIC**

Create great effects!  
**Metallic effects** in texts, images and backgrounds.



**HOLOGRAPHIC GOLD  
HOLOGRAPHIC SILVER**

**Stand out from the crowd!**  
Play with nice **light colour reflections** using the holographic finish.



**PUFFY PRINTING**

Be original! Highlight your brand with our **"Puffy" ink** to give a relief effect to your logo.



**UV PRINTING**

**Highlight your brand with a high gloss finish!** Combine a matt & gloss finish to highlight contrasts and stand out prominently on a **matt background.**



**SANDY**

Create a **sandpaper effect** with a granulated texture.



**PUFFY GLITTER**

Feel & see the coloured **glitter texture!**



**GLOW IN THE DARK**

Make your brand **glow even in the dark.**





The iconic, well-loved and time-honoured shapes of BIC® pocket lighters remain on trend! Five sizes, two ignition systems, one brand and a wide range of colour combinations.

FR > Le célèbre briquet BIC®, une icône indémodable, avec un design toujours tendance ! 5 tailles différentes et une vaste gamme de combinaisons de couleurs.

DE > Das kultige, beliebte und bewährte Design des BIC®- Feuerzeugs liegt weiter im Trend! 5 verschiedene Größen und eine breite Farbkombinationspalette.

ES > El diseño icónico, querido y atemporal del encendedor BIC® sigue siendo tendencia! 5 tamaños distintos y una amplia gama de combinación de colores.

IT > L'iconico, amato e intramontabile design dell'accendino BIC® resta di tendenza! 5 diverse grandezze e una vasta gamma di combinazioni di colori.



**BIC** J25 LIGHTER



2360

New Colour!



01

57

57

57

57

06

Available in *britePix*<sup>™</sup>  
 Disponible en *britePix*<sup>™</sup> / Disponible  
 en *britePix*<sup>™</sup> / Mit *BritePix*<sup>™</sup> erhältlich  
 / Disponible in *britePix*<sup>™</sup>

New Colour!

New Colour!

BIC® Lighters • LIGHTERS



8G

03

5C

59

24

04

25

25

Available in *britePix*<sup>™</sup> / Disponible en *britePix*<sup>™</sup> / Disponible  
 en *britePix*<sup>™</sup> / Mit *BritePix*<sup>™</sup> erhältlich / Disponible in *britePix*<sup>™</sup>

Pastel - 2360

Gold Hood  
2430

All Black  
2364



90

84

85

83

02

02

02

02

Available in *britePix*<sup>™</sup> / Disponible en *britePix*<sup>™</sup> / Disponible  
 en *britePix*<sup>™</sup> / Mit *BritePix*<sup>™</sup> erhältlich / Disponible in *britePix*<sup>™</sup>

Available in *britePix*<sup>™</sup> / Disponible en *britePix*<sup>™</sup> / Disponible  
 en *britePix*<sup>™</sup> / Mit *BritePix*<sup>™</sup> erhältlich / Disponible in *britePix*<sup>™</sup>

\*48h not available in Digital finishes. 48h not available in Digital finishes / \*48h not available in Digital finishes / \*48h not available in Digital finishes / \*48h not available in Digital finishes

## MOQ 300u.

### Decoration:

Personnalisation / Personalización / Dekoration / Decorazione.

#### BIC® J25 LIGHTER

2360/2364/2430

A/C SP: max. 4 col.

#### BIC® J25 LIGHTER *britePix™*

2360/2364/2430

A/C BP: full-colour

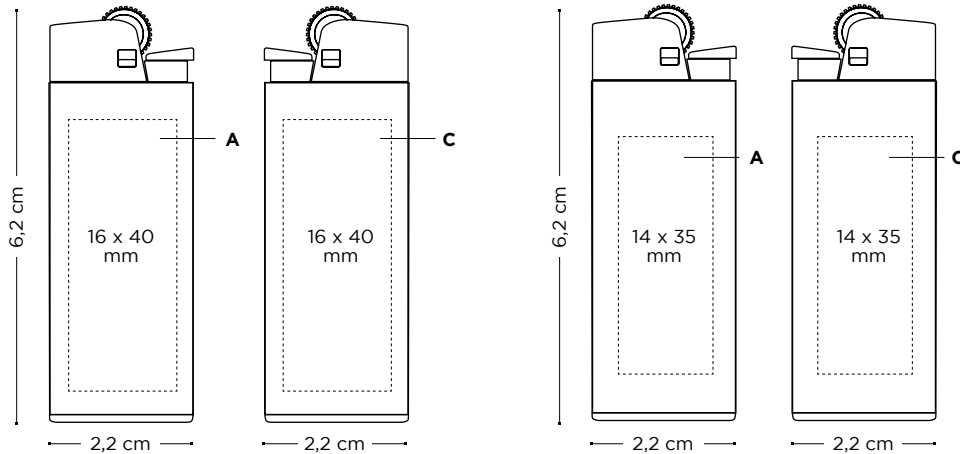

BIC® J25 LIGHTER	Price (€)						
	300-599	600-1199	1200-2999	3000-5099	5100-10199	10200-25199	25200-50099
2360							
SP	1,21	1,12	1,06	1,03	1,01	0,98	0,88
BP	1,44	1,34	1,27	1,23	1,19	1,14	1,04
2364							
SP	1,38	1,34	1,26	1,17	1,11	1,08	1,01
BP	1,62	1,56	1,46	1,37	1,30	1,25	1,17
2430							
SP	1,61	1,49	1,41	1,37	1,34	1,30	1,16
BP	1,84	1,71	1,62	1,57	1,52	1,46	1,33

**Additional imprint charge per colour & position.** Frais d'impression supplémentaires par couleur et position / Cargo por impresión adicional por color y posición / Zusätzliche druckkosten pro farbe & position / Costo marchio aggiuntivo per colore e posizione.

SP	0,13	0,13	0,13	0,13	0,09	0,09	0,09
BP	0,23	0,21	0,20	0,19	0,18	0,16	0,16

**Prices include 1 colour screenprint on one position.** Les prix incluent la sérigraphie 1 couleur sur un emplacement / En precio incluye un color en serigrafía en una posición / In den Preisen inbegriffen ist 1 Siebdruck-Farbaufdruck auf 1 Position / I prezzi includono la serigrafia ad 1 colore in una posizione.

**Prices include britePix™ imprint on body.** Les prix incluent l'impression britePix™ sur le corps / Los precios incluyen impresión en britePix™ en el cuerpo / BritePix™-Aufdruck auf dem Körper in den Preisen inbegriffen / I prezzi includono la stampa britePix™ sul fusto.



### Packaging:

Emballage / Envasado / Verpackung / Imballaggio.

### Printing techniques:

Techniques d'impression / Técnicas de impresión / Drucktechniken / Tecniche di stampa.

### External packaging:

Emballage externe / Envasado exterior / Außenverpackung / Imballaggio esterno.

Up to 1400



Standard Packaging:  
in tray of 50 u



(SP)  
SCREEN  
PRINTING



(BP) britePix™



300 ± 3,8 Kg



Pastel  
MADE IN  
FRANCE



MADE IN  
SPAIN



*Digital Printing!*

**BIC® J25 DIGITAL LIGHTER**  
2360

360°  
100%



BR PUFFY



MATT PUFFY



MATT PUFFY



BR



MATT UV

MOQ 600u.

**Decoration:**

Personnalisation / Personalización / Dekoration / Decorazione.

**BIC® J25 DIGITAL LIGHTER**

2360

**A DG:** full-colour

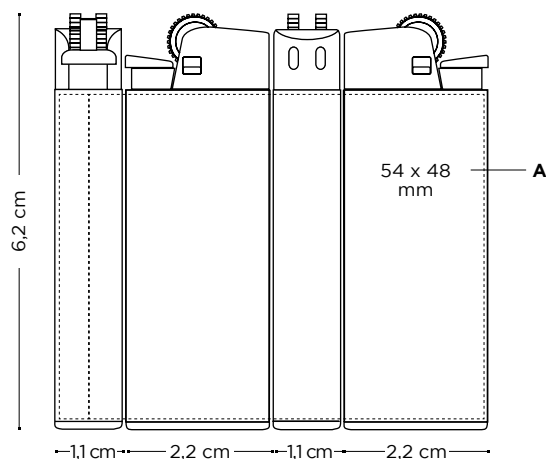

	Price (€)					
<b>BIC® J25 DIGITAL LIGHTER</b>	600-1199	1200-2999	3000-5099	5100-10199	10200-25199	25200-50099
2360						
<b>DG</b>	1,67	1,57	1,48	1,39	1,36	1,27

**Additional charge digital finishes.** Finitions numériques - coût supplémentaire / Cargo adicional acabados digitales / Aufpreis digitale ausführungen / Costi aggiuntivi per finiture digitali.

							MOQ	
<b>BR</b> <b>MATT</b>	Brilliant or Matt						Free	600 u.
<b>H</b>	0,26	0,26	0,26	0,18	0,18	0,18	600 u.	
<b>PUFFY</b>	Puffy printing						-	5.100 u.
<b>M</b>	Metallic						①	50.000 u.
<b>UV</b>	UV						-	5.100 u.
<b>SA</b>	Sandy						-	5.100 u.
<b>PUFFY GLITTER</b>	Puffy Glitter						-	5.100 u.
<b>GLOW</b>	Glow in the dark						-	5.100 u.

**Prices include digital imprint on body.** Les prix incluent l'impression numérique sur le corps. Los precios incluyen impresión digital en el cuerpo / Digital-Aufdruck auf dem Körper in den Preisen inbegriffen. I prezzi includono la stampa digitale sul fusto.

① Price under request. Prix sur demande / Precio bajo consulta / Preis auf Anfrage / Prezzi su richiesta.

Up to 1400



**Packaging:**

Emballage / Envasado / Verpackung / Imballaggio.



Standard Packaging:  
in tray of 50 u

**Printing techniques:**

Techniques d'impression / Técnicas de impresión / Drucktechniken / Tecniche di stampa.



(DG)  
DIGITAL

**External packaging:**

Emballage externe / Envasado exterior / Außenverpackung / Imballaggio esterno.



600 ± 7,6 Kg



MADE IN SPAIN



Slim & fits everywhere!



*New colour!*

2340



57

12

10

100%

03

5C



59

05

24

04

25

02

\*48h not available in Digital finishes



**MOQ 300u.**

**Decoration:**

Personnalisation / Personalización / Dekoration / Decorazione.

**BIC® J23 LIGHTER**

2340

**A/C SP:** max. 4 col.

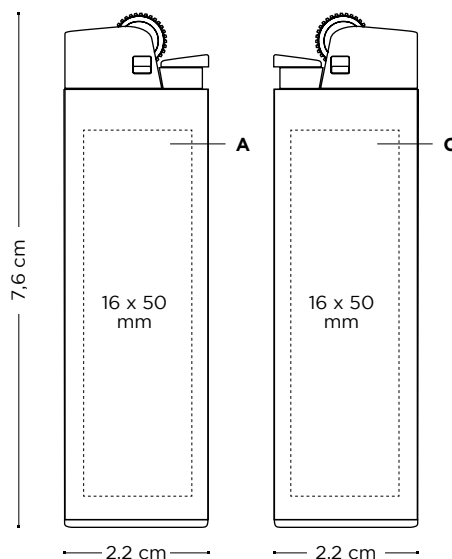

	Price (€)						
<b>BIC® J23 LIGHTER</b>	300-599	600-1199	1200-2999	3000-5099	5100-10199	10200-25199	25200-50099
2340							
<b>SP</b>	1,33	1,27	1,19	1,12	1,09	1,06	1,00

**Additional imprint charge per colour & position.** Frais d'impression supplémentaires par couleur et position / Cargo por impresión adicional por color y posición / Zusätzliche druckkosten pro farbe & position / Costo marchio aggiuntivo per colore e posizione.

<b>SP</b>	0,13	0,13	0,13	0,13	0,09	0,09	0,09
-----------	------	------	------	------	------	------	------

**Prices include 1 colour screenprint on one position.** Les prix incluent la sérigraphie 1 couleur sur un emplacement / En precio incluye un color en serigrafía en una posición / In den Preisen inbegriffen ist 1 Siebdruck-Farbaufdruck auf 1 Position / I prezzi includono la serigrafia ad 1 colore in una posizione.

Up to 1800



**Packaging:**

Emballage / Envasado / Verpackung / Imballaggio.



Standard Packaging:  
in tray of 50 u

**Printing techniques:**

Techniques d'impression / Técnicas de impresión / Drucktechniken / Tecniche di stampa.



(SP)  
SCREEN  
PRINTING

**External packaging:**

Emballage externe / Envasado exterior / Außenverpackung / Imballaggio esterno.



**600 ± 9,5 Kg**



MADE IN  
FRANCE



MATT M

Digital Printing!

**BIC® J23 DIGITAL LIGHTER**  
2340

360°

100%

BR PUFFY



MATT PUFFY UV



BR PUFFY GUMMI



BR

MOQ 600u.

**Decoration:**

Personnalisation / Personalización / Dekoration / Decorazione.

**BIC® J23 DIGITAL LIGHTER**

2340

**A DG:** full-colour

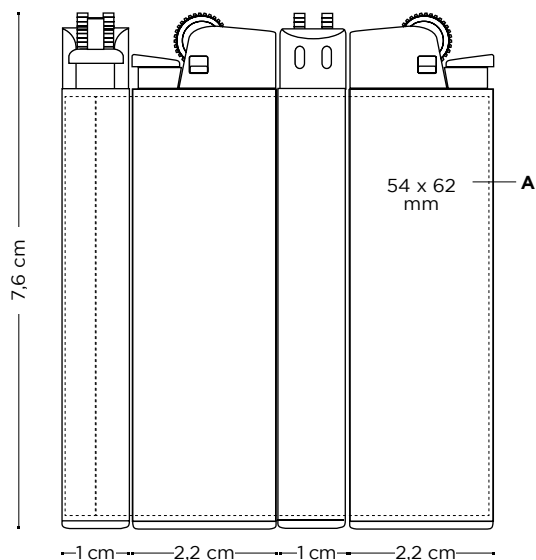

	Price (€)					
<b>BIC® J23 DIGITAL LIGHTER</b>	600-1199	1200-2999	3000-5099	5100-10199	10200-25199	25200-50099
2340						
<b>DG</b>	1,82	1,72	1,63	1,55	1,47	1,37

**Additional charge digital finishes.** Finitions numériques - coût supplémentaire / Cargo adicional acabados digitales / Aufpreis digitale ausföhrungen / Costi aggiuntivi per finiture digitali.

							<b>MOQ</b>	
<b>BR</b> <b>MATT</b>	<b>Brilliant or Matt</b>						Free	600 u.
<b>H</b>	<b>Holographic</b>						0,26 0,26 0,26 0,18 0,18 0,18	600 u.
<b>PUFFY</b>	<b>Puffy printing</b>						- - - 0,18 0,18 0,18	5.100 u.
<b>M</b>	<b>Metallic</b>						①	50.000 u.
<b>UV</b>	<b>UV</b>						- - - 0,18 0,18 0,18	5.100 u.
<b>SA</b>	<b>Sandy</b>						- - - 0,18 0,18 0,18	5.100 u.
<b>PUFFY GLOW</b>	<b>Puffy Glitter</b>						- - - 0,18 0,18 0,18	5.100 u.
<b>GLOW</b>	<b>Glow in the dark</b>						- - - 0,18 0,18 0,18	5.100 u.

**Prices include digital imprint on body.** Les prix incluent l'impression numérique sur le corps. Los precios incluyen impresión digital en el cuerpo / Digital-Aufdruck auf dem Körper in den Preisen inbegriffen. I prezzi includono la stampa digitale sul fusto.

① Price under request. Prix sur demande / Precio bajo consulta / Preis auf Anfrage / Prezzi su richiesta.

Up to 1800

**Packaging:**

Emballage / Envasado / Verpackung / Imballaggio.



Standard Packaging:  
in tray of 50 u

**Printing techniques:**

Techniques d'impression / Técnicas de impresión / Drucktechniken / Tecniche di stampa.



(DG)  
DIGITAL

**External packaging:**

Emballage externe / Envasado exterior / Außenverpackung / Imballaggio esterno.



600 ± 9,5 Kg



MADE IN FRANCE



Extra long-lasting: up to 3.000 lights!



2320



01

57

8G

10

03



59

24

25

06

02

New colour!

100%

\*48h not available in Digital finishes. 48h not available in Digital finishes / \*48h not available in Digital finishes / \*48h not available in Digital finishes / \*48h not available in Digital finishes

MOQ 300u.

**Decoration:**

Personnalisation / Personalización / Dekoration / Decorazione.

**BIC® J26 LIGHTER**

2320

A/C SP: max. 4 col.

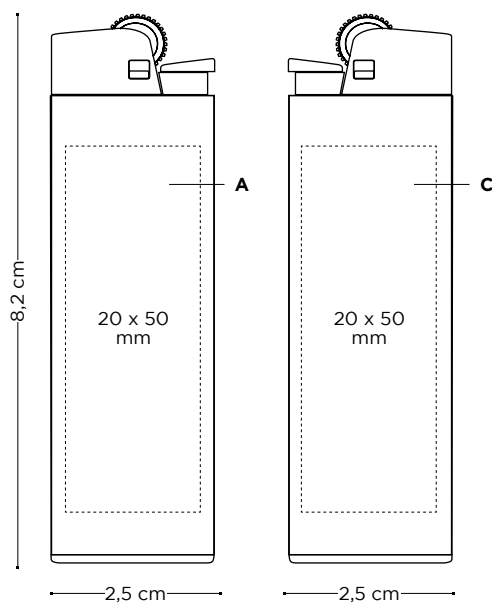

	Price (€)						
<b>BIC® J26 LIGHTER</b>	300-599	600-1199	1200-2999	3000-5099	5100-10199	10200-25199	25200-50099
2320							
<b>SP</b>	1,57	1,45	1,37	1,31	1,24	1,21	1,12

**Additional imprint charge per colour & position.** Frais d'impression supplémentaires par couleur et position / Cargo por impresión adicional por color y posición / Zusätzliche druckkosten pro farbe & position / Costo marchio aggiuntivo per colore e posizione.

<b>SP</b>	0,13	0,13	0,13	0,13	0,09	0,09	0,09
-----------	------	------	------	------	------	------	------

**Prices include 1 colour screenprint on one position.** Les prix incluent la sérigraphie 1 couleur sur un emplacement / En precio incluye un color en serigrafía en una posición / In den Preisen inbegriffen ist 1 Siebdruck-Farbaufdruck auf 1 Position / I prezzi includono la serigrafia ad 1 colore in una posizione.

Up to 3000



**Packaging:**

Emballage / Envasado / Verpackung / Imballaggio.



Standard Packaging:  
in tray of 50 u

**Printing techniques:**

Techniques d'impression / Técnicas de impresión / Drucktechniken / Tecniche di stampa.



(SP)  
SCREEN  
PRINTING

**External packaging:**

Emballage externe / Envasado exterior / Außenverpackung / Imballaggio esterno.



600 ± 15,1 Kg



MADE IN  
SPAIN



# Digital Printing!

**BIC® J26 DIGITAL LIGHTER**  
2320



MATT M PUFFY



BR M



BR H



MATT



MATT UV



MATT M

MOQ 600u.

**Decoration:**

Personnalisation / Personalización / Dekoration / Decorazione.

**BIC® J26 DIGITAL LIGHTER**

2320

**A DG:** full-colour

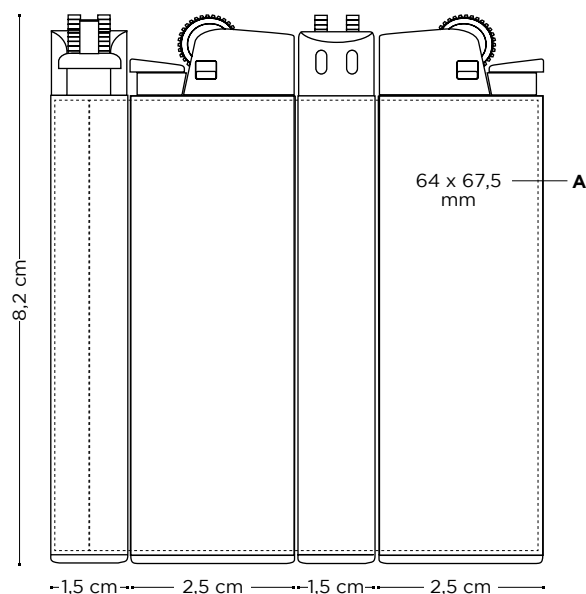

	Price (€)					
<b>BIC® J26 DIGITAL LIGHTER</b>	600-1199	1200-2999	3000-5099	5100-10199	10200-25199	25200-50099
2320						
<b>DG</b>	2,12	2,01	1,90	1,77	1,73	1,63

**Additional charge digital finishes.** Finitions numériques - coût supplémentaire / Cargo adicional acabados digitales / Aufpreis digitale ausföhrungen / Costi aggiuntivi per finiture digitali.

							MOQ	
<b>BR</b> <b>MATT</b>	Brilliant or Matt						Free	600 u.
<b>H</b>	0,26	0,26	0,26	0,18	0,18	0,18	600 u.	
<b>PUFFY</b>	Puffy printing						-	5.100 u.
<b>M</b>	Metallic						①	50.000 u.
<b>UV</b>	-	-	-	0,18	0,18	0,18	5.100 u.	
<b>SA</b>	-	-	-	0,18	0,18	0,18	5.100 u.	
<b>PUFFY GITTER</b>	Puffy Glitter						-	5.100 u.
<b>GLOW</b>	Glow in the dark						-	5.100 u.

**Prices include digital imprint on body.** Les prix incluent l'impression numérique sur le corps. Los precios incluyen impresión digital en el cuerpo / Digital-Aufdruck auf dem Körper in den Preisen inbegriffen. I prezzi includono la stampa digitale sul fusto.

① Price under request. Prix sur demande / Precio bajo consulta / Preis auf Anfrage / Prezzi su richiesta.

Up to 3000



**Packaging:**

Emballage / Envasado / Verpackung / Imballaggio.



Standard Packaging:  
in tray of 50 u

**Printing techniques:**

Techniques d'impression / Técnicas de impresión / Drucktechniken / Tecniche di stampa.



(DG)  
DIGITAL

**External packaging:**

Emballage externe / Envasado exterior / Außenverpackung / Imballaggio esterno.



600 ± 15,1 Kg



MADE IN SPAIN



*Elegant and comfortable lighting!*

Standard - 2452

Gold Hood - 2451



57

57

57

03

25

02

02



\*48h not available in Digital finishes. 48h not available in Digital finishes / \*48h not available in Digital finishes / \*48h not available in Digital finishes / \*48h not available in Digital finishes



MOQ 300u.

**Decoration:**

Personnalisation / Personalización / Dekoration / Decorazione.

**BIC® J38 LIGHTER**

2452/2451

A/B SP: max. 4 col.

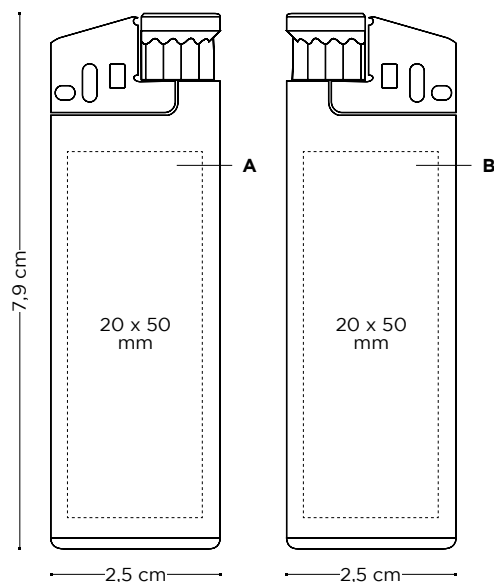

	Price (€)						
<b>BIC® J38 LIGHTER</b>	300-599	600-1199	1200-2999	3000-5099	5100-10199	10200-25199	25200-50099
2452							
<b>SP</b>	1,88	1,79	1,71	1,63	1,55	1,49	1,38
2451							
<b>SP</b>	2,27	2,17	2,07	1,97	1,88	1,82	1,69
<b>Additional imprint charge per colour &amp; position.</b> Frais d'impression supplémentaires par couleur et position / Cargo por impresión adicional por color y posición / Zusätzliche druckkosten pro farbe & position / Costo marchio aggiuntivo per colore e posizione.							
<b>SP</b>	0,13	0,13	0,13	0,13	0,09	0,09	0,09

**Prices include 1 colour screenprint on one position.** Les prix incluent la sérigraphie 1 couleur sur un emplacement / En precio incluye un color en serigrafía en una posición / In den Preisen inbegriffen ist 1 Siebdruck-Farbaufdruck auf 1 Position / I prezzi includono la serigrafia ad 1 colore in una posizione.

Up to 1800



**Packaging:**

Emballage / Envasado / Verpackung / Imballaggio.



Standard Packaging:  
in tray of 50 u

**Printing techniques:**

Techniques d'impression / Técnicas de impresión / Drucktechniken / Tecniche di stampa.



(SP)  
SCREEN  
PRINTING

**External packaging:**

Emballage externe / Envasado exterior / Außenverpackung / Imballaggio esterno.



600 ± 13,2 Kg



MADE IN  
SPAIN

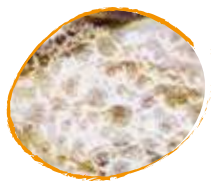

BR SA

**BIC® J38 LIGHTER DIGITAL**  
Standard - 2452



57



360°

100%

57 BR



57



BR PUFFY GLITTER



BR GLOW



MATT M

## MOQ 600u.

### Decoration:

Personnalisation / Personalización / Dekoration / Decorazione.

### BIC® J38 DIGITAL LIGHTER

2452

A DG: full-colour

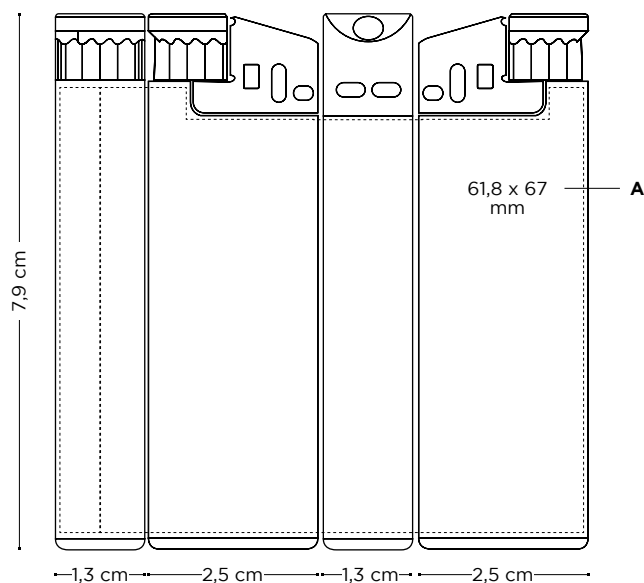

	Price (€)					
<b>BIC® J38 DIGITAL LIGHTER</b>	600-1199	1200-2999	3000-5099	5100-10199	10200-25199	25200-50099
2452						
<b>DG</b>	2,06	1,96	1,87	1,77	1,73	1,59

**Additional charge digital finishes.** Finitions numériques - coût supplémentaire / Cargo adicional acabados digitales / Aufpreis digitale ausführungen / Costi aggiuntivi per finiture digitali.

							MOQ	
<b>BR</b> <b>MATT</b>	Brilliant or Matt						Free	600 u.
<b>H</b>	Holographic						0,26 0,26 0,26 0,18 0,18 0,18	600 u.
<b>PUFFY</b>	Puffy printing						- - - 0,18 0,18 0,18	5.100 u.
<b>M</b>	Metallic						①	50.000 u.
<b>UV</b>	UV						- - - 0,18 0,18 0,18	5.100 u.
<b>SA</b>	Sandy						- - - 0,18 0,18 0,18	5.100 u.
<b>PUFFY GLITTER</b>	Puffy Glitter						- - - 0,18 0,18 0,18	5.100 u.
<b>GLOW</b>	Glow in the dark						- - - 0,18 0,18 0,18	5.100 u.

**Prices include digital imprint on body.** Les prix incluent l'impression numérique sur le corps. Los precios incluyen impresión digital en el cuerpo / Digital-Aufdruck auf dem Körper in den Preisen inbegriffen. I prezzi includono la stampa digitale sul fusto.

① Price under request. Prix sur demande / Precio bajo consulta / Preis auf Anfrage / Prezzi su richiesta.

### Packaging:

Emballage / Envasado / Verpackung / Imballaggio.



Standard Packaging:  
in tray of 50 u

### Printing techniques:

Techniques d'impression / Técnicas de impresión / Drucktechniken / Tecniche di stampa.



(DG)  
DIGITAL

### External packaging:

Emballage externe / Envasado exterior / Außenverpackung / Imballaggio esterno.



600 ± 13,2 Kg



MADE IN SPAIN

Up to 1800





Convenient mini size!

Standard - 2479



\*48h not available in Digital finishes. 48h not available in Digital finishes / \*48h not available in Digital finishes / \*48h not available in Digital finishes / \*48h not available in Digital finishes

MOQ 300u.

**Decoration:**

Personnalisation / Personalización / Dekoration / Decorazione.

**BIC® J39 LIGHTER**

2479

**A/B SP:** max. 4 col.

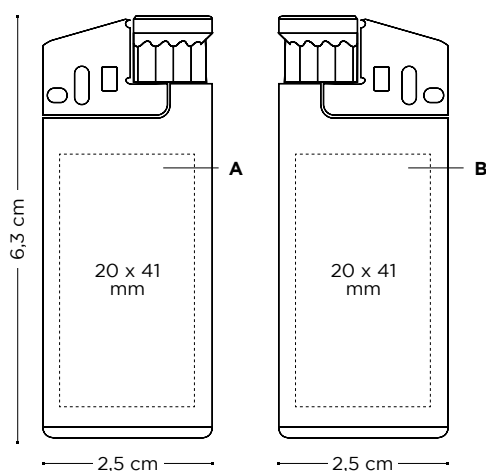

	Price (€)						
<b>BIC® J39 LIGHTER</b>	300-599	600-1199	1200-2999	3000-5099	5100-10199	10200-25199	25200-50099
2479							
<b>SP</b>	1,87	1,77	1,70	1,62	1,54	1,48	1,37

**Additional imprint charge per colour & position.** Frais d'impression supplémentaires par couleur et position / Cargo por impresión adicional por color y posición / Zusätzliche druckkosten pro farbe & position / Costo marchio aggiuntivo per colore e posizione.

<b>SP</b>	0,13	0,13	0,13	0,13	0,09	0,09	0,09
-----------	------	------	------	------	------	------	------

**Prices include 1 colour screenprint on one position.** Les prix incluent la sérigraphie 1 couleur sur un emplacement / En precio incluye un color en serigrafía en una posición / In den Preisen inbegriffen ist 1 Siebdruck-Farbaufdruck auf 1 Position / I prezzi includono la serigrafia ad 1 colore in una posizione.

Up to 1050



**Packaging:**

Emballage / Envasado / Verpackung / Imballaggio.



Standard Packaging:  
in tray of 50 u

**Printing techniques:**

Techniques d'impression / Técnicas de impresión / Drucktechniken / Tecniche di stampa.



(SP)  
SCREEN  
PRINTING

**External packaging:**

Emballage externe / Envasado exterior / Außenverpackung / Imballaggio esterno.



600 ± 11,1 Kg



MADE IN  
SPAIN



MATT SA

*Digital Printing!*

**BIC® J39 LIGHTER DIGITAL**  
Standard - 2479

57

360°

100%

03 BR

57



MATT M



BR



BR GLOW

## MOQ 600u.

### Decoration:

Personnalisation / Personalización / Dekoration / Decorazione.

### BIC® J39 DIGITAL LIGHTER

2479

A DG: full-colour

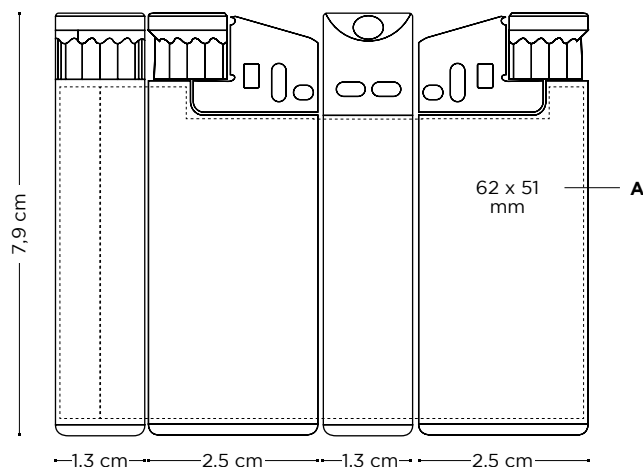

	Price (€)					
<b>BIC® J39 DIGITAL LIGHTER</b>	600-1199	1200-2999	3000-5099	5100-10199	10200-25199	25200-50099
2479						
<b>DG</b>	2,00	1,91	1,82	1,73	1,68	1,56

**Additional charge digital finishes.** Finitions numériques - coût supplémentaire / Cargo adicional acabados digitales / Aufpreis digitale ausföhrungen / Costi aggiuntivi per finiture digitali.

							MOQ	
<b>BR</b> <b>MATT</b>	Brilliant or Matt						Free	600 u.
<b>H</b>	Holographic						0,26 0,26 0,26 0,18 0,18 0,18	600 u.
<b>PUFFY</b>	Puffy printing						- - - 0,18 0,18 0,18	5.100 u.
<b>M</b>	Metallic						①	50.000 u.
<b>UV</b>	UV						- - - 0,18 0,18 0,18	5.100 u.
<b>SA</b>	Sandy						- - - 0,18 0,18 0,18	5.100 u.
<b>PUFFY GITTER</b>	Puffy Glitter						- - - 0,18 0,18 0,18	5.100 u.
<b>GLOW</b>	Glow in the dark						- - - 0,18 0,18 0,18	5.100 u.

**Prices include digital imprint on body.** Les prix incluent l'impression numérique sur le corps. Los precios incluyen impresión digital en el cuerpo / Digital-Aufdruck auf dem Körper in den Preisen inbegriffen. I prezzi includono la stampa digitale sul fusto.

① Price under request. Prix sur demande / Precio bajo consulta / Preis auf Anfrage / Prezzi su richiesta.

### Packaging:

Emballage / Envasado / Verpackung / Imballaggio.



Standard Packaging:  
in tray of 50 u

### Printing techniques:

Techniques d'impression / Técnicas de impresión / Drucktechniken / Tecniche di stampa.



(DG)  
DIGITAL

### External packaging:

Emballage externe / Envasado exterior / Außenverpackung / Imballaggio esterno.



600 ± 11,1 Kg



MADE IN  
SPAIN

Up to 1050



Easy and comfortable to light thanks to its beam wand



2500 - 01

New colour!



2500 - 03

100%



Comes in an individual box!  
Customise it from 2,500 units





MOQ 100u.

**Decoration:**

Personnalisation / Personalización / Dekoration / Decorazione.

**BIC® MEGA LIGHTER**

2500

**A PD:** max. 2 col.    **B PD:** max. 2 col.    **B BP:** full-colour  
**BP Texture:** full-colour

Individual carton box:

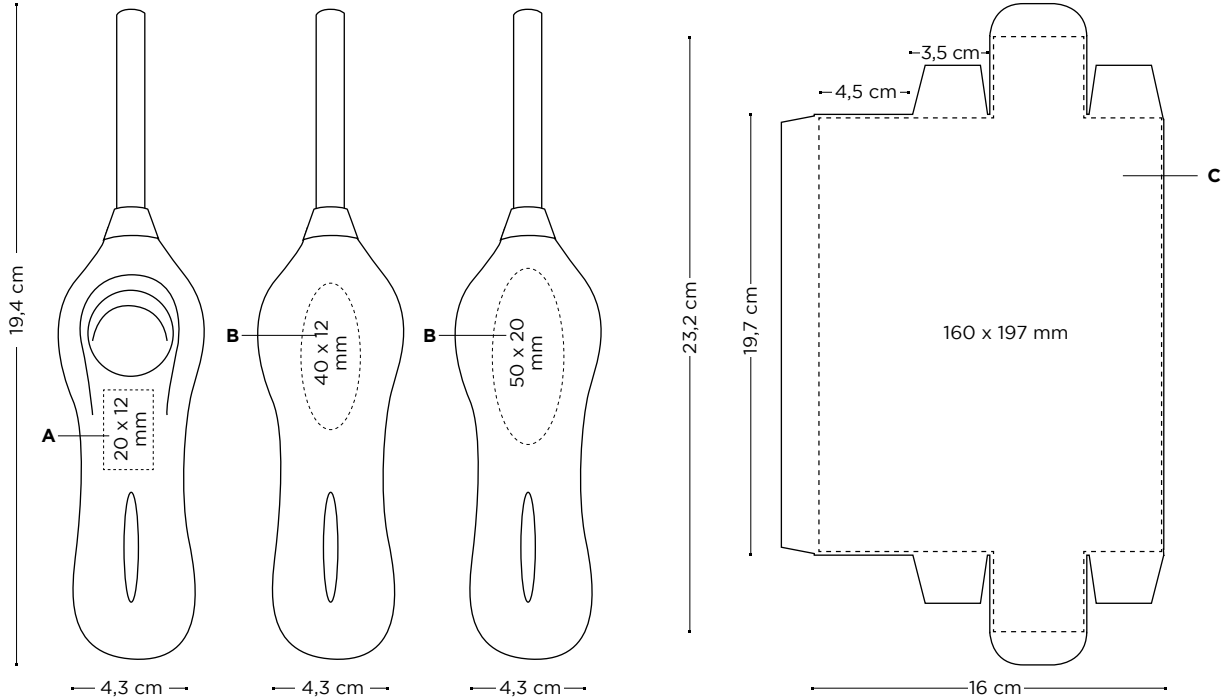

Price (€)

BIC® MEGA LIGHTER	100-299	300-599	600-1199	1200-2999	3000-5099	5100-10199	10200-25199
2500							
<b>PD</b>	5,81	5,55	5,27	4,98	4,78	4,64	4,51
<b>BP</b>	6,40	6,10	5,80	5,53	5,26	5,11	4,97

**Additional imprint charge per colour & position.** Frais d'impression supplémentaires par couleur et position / Cargo por impresión adicional por color y posición / Zusätzliche druckkosten pro farbe & position / Costo marchio aggiuntivo per colore e posizione.

<b>PD</b>	1,39	1,36	1,32	1,28	1,28	1,28	1,28
<b>BP Texture</b> (not available on red colour)	1,19	1,15	1,11	1,07	1,06	1,06	1,06

**Prices include 1 colour padprint in one position.** Les prix incluent la tampographie monochrome sur un emplacement / Los precios incluyen una color en tampografía en una posición / In den Preisen inbegriffen ist ein Tampondruck-Aufdruck auf einer Position / I prezzi includono 1 colore con stampa a tampone in una posizione.

**Prices include britePix™ imprint on body.** Les prix incluent l'impression britePix™ sur le corps / Los precios incluyen impresión en britePix™ en el cuerpo / BritePix™-Aufdruck auf dem Körper in den Preisen inbegriffen / I prezzi includono la stampa britePix™ sul fusto.

**Additional charge for customer logo printed on the box (from 2.500 u.)**

<b>DG</b>	-	-	-	0,84	0,69	0,49	0,29
-----------	---	---	---	------	------	------	------

**Prices include fully personalised packaging in 4-colour process.** Le prix inclut l'emballage totalement personnalisée en quadrichromie / Los precios incluyen un envasado totalmente personalizado en cuatricromía / In den Preisen sind mit Vierfarbdruck voll personalisierte Verpackungen inbegriffen / I prezzi includono imballaggi completamente personalizzati in quadricromia.

Up to 750

Conform ISO 22702

**Packaging:**  
Emballage / Envasado /  
Verpackung / Imballaggio.



Standard packaging:  
individual carton box

**Printing techniques:**  
Techniques d'impression / Técnicas de  
impresión / Drucktechniken / Tecniche  
di stampa.



(PD) PAD  
PRINTING



(BP) britePix™



(DG)  
DIGITAL



**External packaging:**  
Emballage externe / Envasado  
exterior / Außenverpackung /  
Imballaggio esterno.



100 ± 8,3 Kg

2386



01

47

100%

Neon - 2386



2F

1G

5C

59

100%

MOQ 100u.

**Decoration:**

Personnalisation / Personalización / Dekoration / Decorazione.

**BIC® STYL'IT LUXURY CASE**  
2386

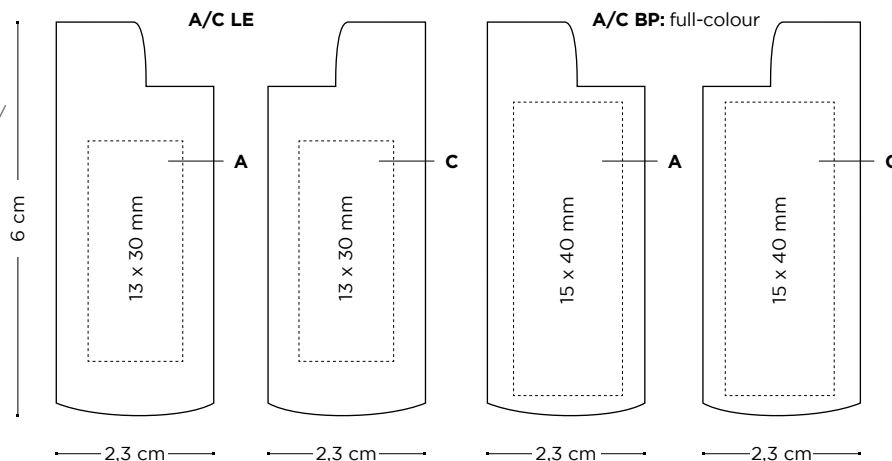

Price (€)

**BIC® STYL'IT LUXURY CASE** 100-299 300-599 600-1199 1200-2999 3000-5099 5100-10199 10200-25199  
2386

<b>LE</b>	4,31	4,11	3,85	3,72	①	①	①
<b>BP</b> (not available for Neon colours)	3,35	3,24	3,09	2,95	①	①	①

**Additional imprint charge per colour & position.** Frais d'impression supplémentaires par couleur et position / Cargo por impresión adicional por color y posición / Zusätzliche druckkosten pro farbe & position / Costo marchio aggiuntivo per colore e posizione.

<b>LE</b>	1,21	1,09	0,96	0,96	①	①	①
<b>BP</b> (not available for Neon colours)	0,25	0,22	0,20	0,19	①	①	①

**Prices include 1 imprint in one position according to specified technique.**

① Price under request. Prix sur demande / Precio bajo consulta / Preis auf Anfrage / Prezzi su richiesta.

**Packaging:**

Emballage / Envasado / Verpackung / Imballaggio.



Standard Packaging:  
box for 10 units

**Printing techniques:**

Techniques d'impression / Técnicas de impresión / Drucktechniken / Tecniche di stampa.



(LE) LASER



(BP) britePix™



**External packaging:**

Emballage externe / Envasado exterior / Außenverpackung / Imballaggio esterno.



300 ± 6,1 Kg

Soft - 2153



01

47



25

02

Metallic - 2161



47

02

MOQ 100u.

Decoration:

Personnalisation / Personalización / Dekoration / Decorazione.

BIC® STYL'IT LUXURY CASE

2153/2161

A/C LE

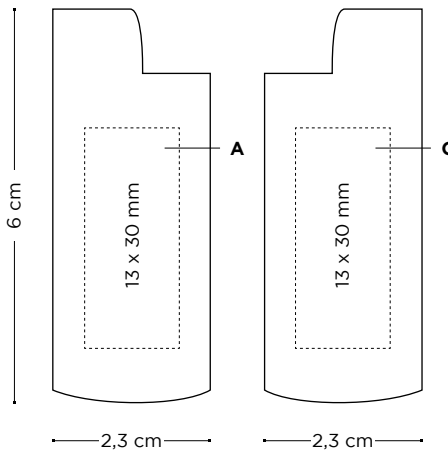

	Price (€)						
BIC® STYL'IT LUXURY CASE	100-299	300-599	600-1199	1200-2999	3000-5099	5100-10199	10200-25199
2153							
LE	4,52	4,37	4,18	4,02	①	①	①
2161							
LE	4,83	4,62	4,35	4,20	①	①	①
<b>Additional imprint charge per colour &amp; position.</b>	<b>Frais d'impression supplémentaires par couleur et position / Cargo por impresión adicional por color y posición / Zusätzliche druckkosten pro farbe &amp; position / Costo marchio aggiuntivo per colore e posizione.</b>						
LE	1,21	1,09	0,96	0,96	①	①	①

**Prices include imprint in 1 position.** Le prix inclut 1 impression sur 1 position / Los precios incluyen 1 impresión en una posición / Preise inklusive eines Aufdruckes an einer Position / I prezzo include 1 stampa in 1 posizione.

① Price under request. Prix sur demande / Precio bajo consulta / Preis auf Anfrage / Prezzi su richiesta.

Packaging:

Emballage / Envasado / Verpackung / Imballaggio.



Standard Packaging:  
box for 10 units

Printing techniques:

Techniques d'impression / Técnicas de impresión / Drucktechniken / Tecniche di stampa.



(LE)  
LASER

External packaging:

Emballage externe / Envasado exterior / Außenverpackung / Imballaggio esterno.



300 ± 6,1 Kg

3 customisable sides!

2156



MOQ 100u.

**Decoration:**

Personalisation / Personalización / Dekoration / Decorazione.

**BIC® ALUMINIUM FLAT CASE**

2156

**New!** A/C PD: max. 1 col.

A/B/C BP: full-colour

A/B/C LE

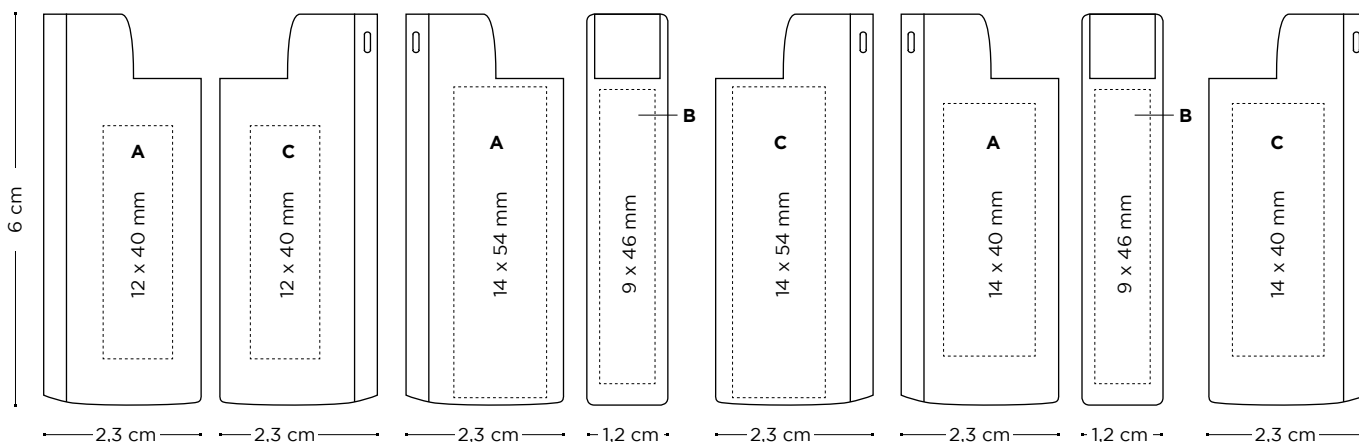

Price (€)

BIC® ALUMINIUM FLAT CASE	100-299	300-599	600-1199	1200-2999	3000-5099	5100-10199	10200-25199
2156							
BP	2,14	2,06	1,95	1,86	①	①	①
LE	3,10	2,93	2,71	2,63	①	①	①
PD	1,93	1,85	1,76	1,67	①	①	①

**Additional imprint charge per colour & position.** Frais d'impression supplémentaires par couleur et position / Cargo por impresión adicional por color y posición / Zusätzliche druckkosten pro farbe & position / Costo marchio aggiuntivo per colore e posizione.

BP	0,25	0,22	0,20	0,19	①	①	①
LE	1,21	1,09	0,96	0,96	①	①	①
PD	0,29	0,25	0,18	0,18	①	①	①

Prices include 1 imprint in one position according to specified technique.

① Price under request. Prix sur demande / Precio bajo consulta / Preis auf Anfrage / Prezzi su richiesta.

**Packaging:**

Emballage / Envasado / Verpackung / Imballaggio.



Standard Packaging: box for 10 units

**Printing techniques:**

Techniques d'impression / Técnicas de impresión / Drucktechniken / Tecniche di stampa.



(PD) PAD PRINTING



(LE) LASER



(BP) britePix™

**External packaging:**

Emballage externe / Envasado exterior / Außenverpackung / Imballaggio esterno.



300 ± 6,9 Kg

2398



01

03

02

100%

**MOQ 100u.**

**Decoration:**

Personnalisation / Personalización / Dekoration / Decorazione.

**BIC® CLIP CASE**

2398

A/C PD: max. 1 col.

A/C BP: full-colour

BP Texture: full-colour

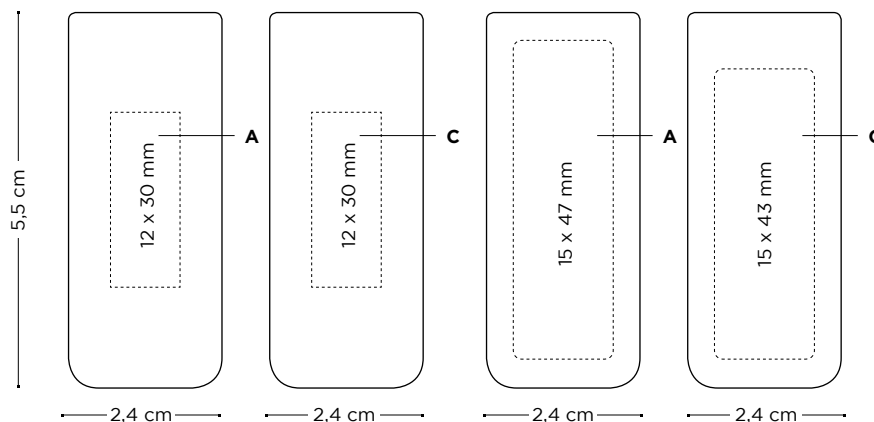

Price (€)

BIC® CLIP CASE	100-299	300-599	600-1199	1200-2999	3000-5099	5100-10199	10200-25199
2398							
BP	1,76	1,65	1,52	1,47	①	①	①

**Additional imprint charge per colour & position.** Frais d'impression supplémentaires par couleur et position / Cargo por impresión adicional por color y posición / Zusätzliche druckkosten pro farbe & position / Costo marchio aggiuntivo per colore e posizione.

BP Texture	0,19	0,17	0,15	0,14	①	①	①
BP	0,25	0,22	0,20	0,19	①	①	①

**britePix™: imprint on body.** britePix™: impression sur le corps. / britePix™: impresión en el cuerpo / britePix™: Aufdruck auf Hülle / britePix™: stampa sul corpo.

① Price under request. Prix sur demande / Precio bajo consulta / Preis auf Anfrage / Prezzi su richiesta.

**Packaging:**

Emballage / Envasado / Verpackung / Imballaggio.



Standard Packaging:  
box for 50 units

**Printing techniques:**

Techniques d'impression / Técnicas de impresión / Drucktechniken / Tecniche di stampa.



(PD) PAD PRINTING



(BP) britePix™



**External packaging:**

Emballage externe / Envasado exterior / Außenverpackung / Imballaggio esterno.



**300** ± 7,5 Kg



Convert your logo into a 3D shape!

2395



MOQ 1.200u.

**Decoration:**

Personnalisation / Personalización / Dekoration / Decorazione.

**BIC® 3D CASE**

2395

A/C 3D: max. 6 col.

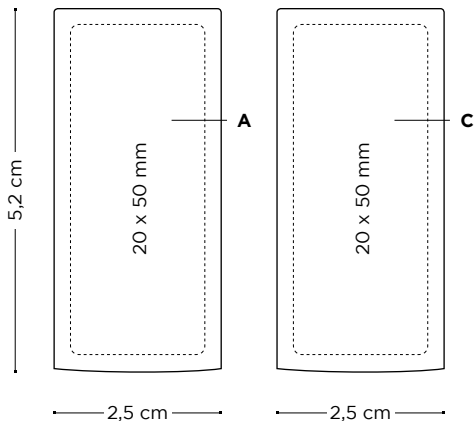

BIC® 3D CASE	1200-2999	3000-5099	5100-10199	10200-25199	Price (€)
2395					
<b>3D</b>	4,74	4,49	4,27	①	①

**Additional imprint charge per colour & position.** Frais d'impression supplémentaires par couleur et position / Cargo por impresión adicional por color y posición / Zusätzliche druckkosten pro farbe & position / Costo marchio aggiuntivo per colore e posizione.

<b>3D embossing on side B (1 colour)</b>	0,17	0,15	0,15	①	①
<b>Additional embossed colours</b>	0,10	0,09	0,09	①	①

**Price includes 3D embossing in 1 colour in 1 position.** Le prix inclut le gaufrage 3D en 1 couleur sur 1 emplacement / El precio incluye termograbado 3D em 1 color y una posición / 3D-Prägung in 1 Farbe auf 1 Position im Preis inbegriffen / Il prezzo include stampa a caldo in 3D ad un colore in una posizione.

**Packaging:**

Emballage / Envasado / Verpackung / Imballaggio.



Standard Packaging:  
box for 50 units

**Printing techniques:**

Techniques d'impression / Técnicas de impresión / Drucktechniken / Tecniche di stampa.



3D embossing

**External packaging:**

Emballage externe / Envasado exterior / Außenverpackung / Imballaggio esterno.



300 ± 7,5 Kg

Please contact your Customer Service Representative for further details. Pour de plus amples détails, veuillez contacter notre service clients / Para más detalles, por favor contacta con tu representante de atención al cliente / Bitte setzen Sie sich mit Ihrem Customer-Service-Vertreter in Verbindung, um mehr Details zu erfahren / Contatta il tuo rappresentante del servizio clienti per maggiori informazioni.

3850



75%

Kraft - 3851



75%

**Decoration:**

Personalisation / Personalización / Dekoration / Decorazione.

**BIC® POCKET ASHTRAY**  
**MOQ 5.000u.**

3850

**A SP:** max. 5 col.

(max. 2 col. for orders under 20.000 pcs.)

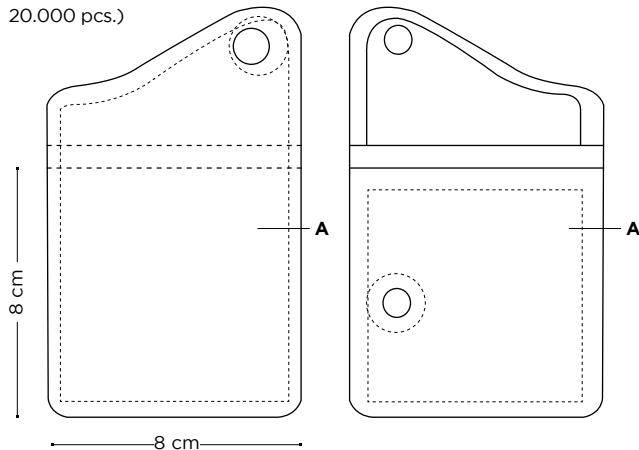

Price (€)

<b>BIC® POCKET ASHTRAY</b>	5000-9999	10000-19999	20000-24999	25000-49999	50000-74999	75000-9999	>100000
3850							
<b>SP</b>	0,88	0,77	0,70	0,67	①	①	①

**BIC® POCKET ASHTRAY KRAFT**  
**MOQ 10.000u.**

3851

**A SP:** max. 2 col.

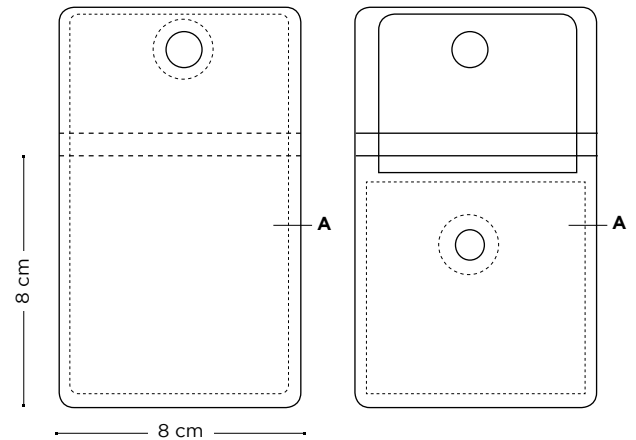

Price (€)

<b>BIC® POCKET ASHTRAY</b>	10000-19999	20000-24999	25000-49999	50000-74999
3851				
<b>SP</b>	0,94	0,85	0,82	①

**Price includes 1 imprint colour and legal text.** Le prix inclut l'impression en 1 couleur et le texte légal / Los precios incluyen 1 impresión en 1 color y el texto legal / 1 Aufdruckfarbe und Rechtshinweis im Preis inbegriffen / Il prezzo include la stampa a 1 colore e testo legale.  
① Price under request. Prix sur demande / Precio bajo consulta / Preis auf Anfrage / Prezzi su richiesta.

**Packaging:**

Emballage / Envasado / Verpackung / Imballaggio.



Box for 10 u. Each BIC® Pocket Ashtray comes in an individual cellophane packaging.

Please contact your Customer Service Representative for further details.

**Printing techniques:**

Techniques d'impression / Técnicas de impresión / Drucktechniken / Tecniche di stampa.



(SP)  
SCREEN  
PRINTING

**External packaging:**

Emballage externe / Envasado exterior / Außenverpackung / Imballaggio esterno.



**500** ± 5,5 Kg

**Check out the video**

Regardez la video / Mira el video / Produktvideo / Guarda il video.



**FOR MEN**

**274** BIC® Comfort 2 For Men

**276** BIC® Flex3 Classic For Men

**278** BIC® Flex4 For Men

**FOR WOMEN**

**280** BIC® Comfort 2 Lady Form  
Women

**282** BIC® Pure 3 Lady For  
Women

**284** BIC® Soleil Bella Lady For  
Women





# Shavers

270 — 285



To cut the hair without irritating the skin, the blade edge, invisible to the naked eye, must be perfectly smooth. Finding the balance between features like comfort, smoothness or closeness is key to meet user expectations

FR > Pour couper les poils sans irriter la peau, le fil de la lame, invisible à l'œil nu, doit être parfaitement aiguisé. Trouver l'équilibre entre le confort, la douceur et la précision est la clé pour répondre aux attentes de l'utilisateur.

DE > Um die Haare zu rasieren, ohne die Haut zu reizen, muss die Klingenkante - mit bloßem Auge unsichtbar - perfekt glatt sein. Das richtige Gleichgewicht aus Charakteristika wie Komfort, Glätte und Gründlichkeit ist der Schlüssel, um den Erwartungen der Benutzer gerecht zu werden.

ES > Para cortar el pelo sin irritar la piel, el borde de la hoja, inapreciable a simple vista debe ser perfectamente suave. Encontrar el equilibrio entre características como confort, suavidad o apurados es clave para satisfacer las expectativas de los usuarios.

IT > Per tagliare il pelo senza irritare la pelle, il bordo della lama, invisibile a occhio nudo, deve essere perfettamente liscio. Trovare il perfetto equilibrio tra comfort, delicatezza e precisione è fondamentale per soddisfare le aspettative dell'acquirente







MOQ 500u.

**BIC® COMFORT 2**  
3128



FR > Manche anti-dérapant en polystyrène / Rasoir deux lames / Grande bande lubrifiante à l'aloë vera et aux vitamines A et E / Tête fixe étroite

DE > Rutschfester Polystyren-Griff / Zwei-Klingen-Rasierer / Großer Gleitstreifen mit Aloe Vera, Vitamin A und E / Fester schmaler Kopf

ES > Mango antideslizante de poliestireno / Maquinilla de dos hojas / Gran banda lubricante con aloe vera, vitaminas A y E / Cabezal fijo y estrecho

IT > Impugnatura antiscivolo in polistirene / Rasoio a doppia lama / Ampia striscia lubrificante con aloe vera, vitamina A ed E / Testa del rasoio rigida e stretta

**Printing techniques:**

Techniques d'impression / Técnicas de impresión / Drucktechniken / Tecniche di stampa



(DG)  
DIGITAL



## Decoration:

Personnalisation / Personalización / Dekoration / Decorazione

### BIC® COMFORT 2

3128

#### FLOW PACK (SMALL)

**A DG:** full-colour

Shaver +  
Flow Pack



Shaver + Gel +  
Flow Pack

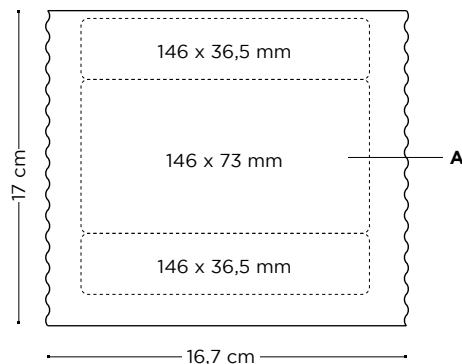

Price (€)

BIC® COMFORT 2	500-999	1000-2499	2500-4999	5000-9999	10000-24999	25000-49999
Shaver + Flow Pack						
<b>DG</b>	1,62	1,06	0,78	0,59	0,47	0,41
Shaver + Gel + Flow Pack						
<b>DG</b>	1,95	1,39	1,08	0,89	①	①

**Prices include fully personalised packaging in 4-colour process.** Le prix inclut l'emballage totalement personnalisé en quadrichromie. Los precios incluyen el envasado totalmente personalizado en cuatricromía. In den Preisen sind mit Vierfarbdruck voll personalisierte Verpackungen inbegriffen. I prezzi includono imballaggio completamente personalizzato con processo in quadricromia  
 ① Price under request. Prix sur demande. Precio bajo consulta. Preis auf Anfrage. Prezzi su richiesta.

#### CARTON BOX (SMALL)

**A DG:** full-colour

Shaver +  
Carton Box



Shaver + Gel +  
Carton Box

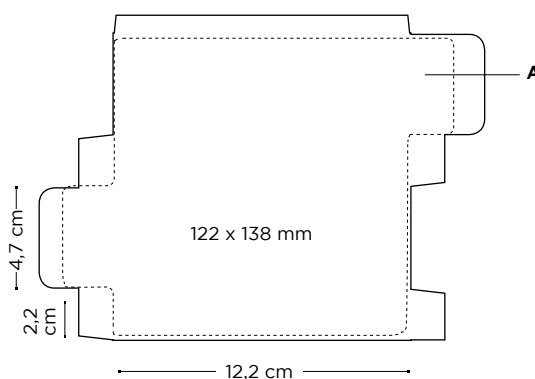

Price (€)

BIC® COMFORT 2	500-999	1000-2499	2500-4999	5000-9999	10000-24999	25000-49999
Shaver + Carton Box						
<b>DG</b>	2,54	1,51	0,98	0,72	0,54	0,46
Shaver + Gel + Carton Box						
<b>DG</b>	2,87	1,84	1,28	1,02	①	①

**Prices include fully personalised packaging in 4-colour process.** Le prix inclut l'emballage totalement personnalisé en quadrichromie. Los precios incluyen el envasado totalmente personalizado en cuatricromía. In den Preisen sind mit Vierfarbdruck voll personalisierte Verpackungen inbegriffen. I prezzi includono imballaggio completamente personalizzato con processo in quadricromia  
 ① Price under request. Prix sur demande. Precio bajo consulta. Preis auf Anfrage. Prezzi su richiesta.





MOQ 500u.

BIC® FLEX3 CLASSIC™  
3129



07

FR > Grande barre de protection / Tête pivotante qui épouse les contours du visage / Bande lubrifiante à l'aloë vera et à la vitamine E / 3 lames mobiles / Poignée incurvée à prise souple pour un bon contrôle du rasage

ES > Gran barra de protección / Cabezal pivotante para adaptarse a los contornos de la cara / Banda lubricante con aloe vera y vitamina E / 3 hojas móviles / Mango curvo con grip suave para un mejor control de afeitado

DE > Großer Schutzstreifen / Beweglicher Kopf passt sich den Gesichtskonturen an / Gleitstreifen mit Aloe Vera und Vitamin E / 3 bewegliche Klingen / Geschwungener Softgriff für eine kontrollierte Rasur

IT > Ampia barretta di sicurezza / Testa pivotante che si adatta ai contorni del viso / Striscia lubrificante con aloe vera e vitamina E / 3 lame mobili / Manico curvo con impugnatura morbida per un buon controllo della rasatura



(DG)  
DIGITAL

## Decoration:

Personnalisation / Personalización / Dekoration / Decorazione

### BIC® Flex3 Classic™

3129

#### FLOW PACK (SMALL)

**A DG:** full-colour

Shaver +  
Flow Pack

Shaver + Gel +  
Flow Pack

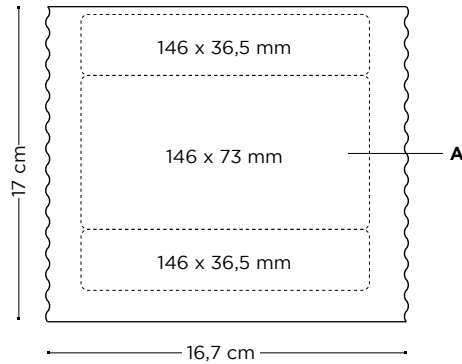

BIC® FLEX3 CLASSIC™	Price (€)					
	500-999	1000-2499	2500-4999	5000-9999	10000-24999	25000-49999
Shaver + Flow Pack						
<b>DG</b>	2,05	1,47	1,17	0,96	0,82	0,74
Shaver + Gel + Flow Pack						
<b>DG</b>	2,38	1,80	1,47	1,26	①	①

Prices include fully personalised packaging in 4-colour process. Le prix inclut l'emballage totalement personnalisé en quadrichromie. Los precios incluyen el envasado totalmente personalizado en cuatricromía. In den Preisen sind mit Vierfarbdruck voll personalisierte Verpackungen inbegriffen. I prezzi includono imballaggio completamente personalizzato con processo in quadricromia  
① Price under request. Prix sur demande. Precio bajo consulta. Preis auf Anfrage. Prezzi su richiesta.

#### CARTON BOX (SMALL)

**A DG:** full-colour

Shaver +  
Carton Box

Shaver + Gel +  
Carton Box

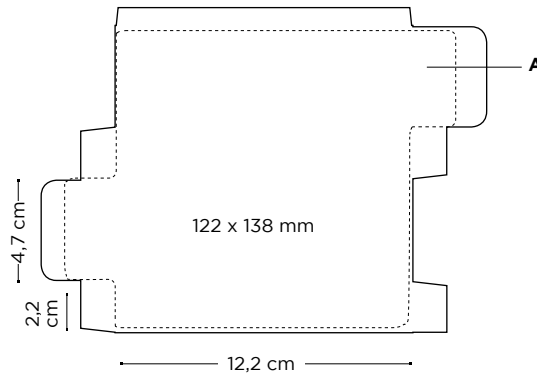

BIC® FLEX3 CLASSIC™	Price (€)					
	500-999	1000-2499	2500-4999	5000-9999	10000-24999	25000-49999
Shaver + Carton Box						
<b>DG</b>	2,97	1,92	1,37	1,09	0,89	0,79
Shaver + Gel + Carton Box						
<b>DG</b>	3,30	2,25	1,67	1,39	①	①

Prices include fully personalised packaging in 4-colour process. Le prix inclut l'emballage totalement personnalisé en quadrichromie. Los precios incluyen el envasado totalmente personalizado en cuatricromía. In den Preisen sind mit Vierfarbdruck voll personalisierte Verpackungen inbegriffen. I prezzi includono imballaggio completamente personalizzato con processo in quadricromia  
① Price under request. Prix sur demande. Precio bajo consulta. Preis auf Anfrage. Prezzi su richiesta.

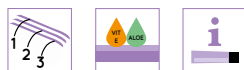

Movable Blades  
Lames amovibles  
Hojas móviles  
Bewegliche Klingen  
Lame mobili



MADE IN EUROPE



MADE IN GREECE



MOQ 500u.

**BIC® FLEX4**  
3130



02

FR > Grande barre de protection / Tête pivotante / Bande lubrifiante à l'aloë vera et à la vitamine E / 4 lames nano technologie, qui épousent individuellement les contours du visage / Manche ergonomique lourd, avec zone de préhension caoutchoutée

ES > Gran barra de protección / Cabezal pivotante / Banda lubricante con aloë vera y vitamina E / 4 hojas hechas con nano tecnología, se adaptan individualmente al contorno de la cara / Mango de fácil manejo con agarre de goma

DE > Großer Schutzstreifen / Beweglicher Kopf / Gleitstreifen mit Aloe Vera und Vitamin E / 4 Nanotechnologie-Klingen passen sich den Gesichtskonturen individuell an / Komfortabler schwerer Griff mit Gummierung

IT > Ampia barretta di sicurezza / Testa pivotante / Striscia lubrificante con aloë vera e vitamina E / 4 lame nano tech che si adattano singolarmente ai contorni del viso / Impugnatura comoda e pesante con gomma antiscivolo



**Printing techniques:**

Techniques d'impression / Técnicas de impresión / Drucktechniken / Tecniche di stampa



(DG)  
DIGITAL



## Decoration:

Personnalisation / Personalización / Dekoration / Decorazione

### BIC® Flex4

3130

#### FLOW PACK (BIG)

**A DG:** full-colour

Shaver +  
Flow Pack

Shaver + Gel +  
Flow Pack

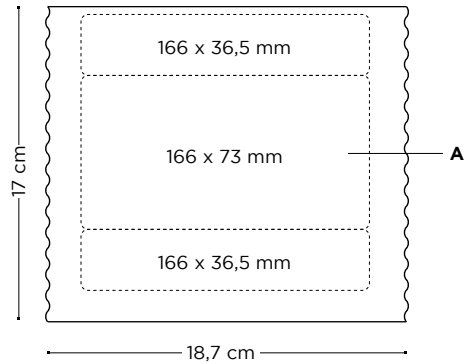

Price (€)

BIC® FLEX4	500-999	1000-2499	2500-4999	5000-9999	10000-24999	25000-49999
Shaver + Flow Pack						
<b>DG</b>	2,35	1,75	1,43	1,20	1,05	0,96
Shaver + Gel + Flow Pack						
<b>DG</b>	2,68	2,08	1,73	1,50	①	①

**Prices include fully personalised packaging in 4-colour process.** Le prix inclut l'emballage totalement personnalisé en quadrichromie. Los precios incluyen el envasado totalmente personalizado en cuatricromía. In den Preisen sind mit Vierfarbdruck voll personalisierte Verpackungen inbegriffen. I prezzi includono imballaggio completamente personalizzato con processo in quadricromia  
 ① Price under request. Prix sur demande. Precio bajo consulta. Preis auf Anfrage. Prezzi su richiesta.

#### CARTON BOX (BIG)

**A DG:** full-colour

Shaver +  
Carton Box

Shaver + Gel +  
Carton Box

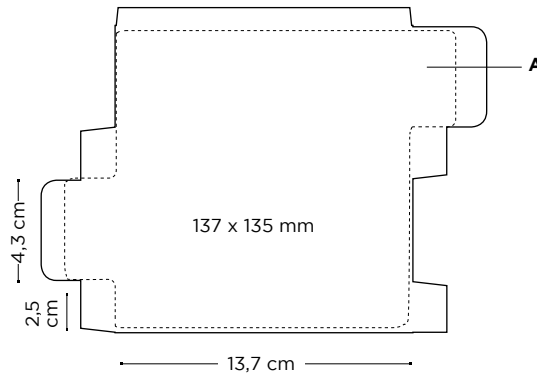

Price (€)

BIC® FLEX4	500-999	1000-2499	2500-4999	5000-9999	10000-24999	25000-49999
Shaver + Carton Box						
<b>DG</b>	3,44	2,28	1,68	1,37	1,15	1,04
Shaver + Gel + Carton Box						
<b>DG</b>	3,77	2,61	1,98	1,67	①	①

**Prices include fully personalised packaging in 4-colour process.** Le prix inclut l'emballage totalement personnalisé en quadrichromie. Los precios incluyen el envasado totalmente personalizado en cuatricromía. In den Preisen sind mit Vierfarbdruck voll personalisierte Verpackungen inbegriffen. I prezzi includono imballaggio completamente personalizzato con processo in quadricromia  
 ① Price under request. Prix sur demande. Precio bajo consulta. Preis auf Anfrage. Prezzi su richiesta.

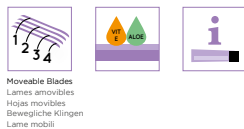

Moveable Blades  
Lames amovibles  
Hojas móviles  
Bewegliche Klappen  
Lame mobili

www.bicgraphic.eu

279



MOQ 500u.

**BIC® COMFORT 2 LADY**  
3131



FR > 2 lames / Grande bande lubrifiante à la vitamine E / Tête fixe / Manche court et léger en polystyrène

DE > 2 Klingen / Großer Gleitstreifen mit Vitamin E / Fester Kopf / Leichter, kurzer Polystyren-Griff

ES > 2 hojas / Banda lubricante con vitamina E / Cabezal fijo / Mango corto y ligero de poliestireno.

IT > 2 lame / Ampia striscia lubrificante con vitamina E / Testa rigida / Manico leggero e corto in polistirene

**Printing techniques:**

Techniques d'impression / Técnicas de impresión / Drucktechniken / Tecniche di stampa



(DG)  
DIGITAL

(Until stock lasts) Jusqu'à épuisement du stock / Hasta que se acabe el stock / Solange der Vorrat reicht / Fino a esaurimento scorte



## Decoration:

Personnalisation / Personalización / Dekoration / Decorazione

### BIC® Comfort 2 Lady

3131

#### FLOW PACK (SMALL)

**A DG:** full-colour

Shaver +  
Flow Pack



Shaver + Gel +  
Flow Pack

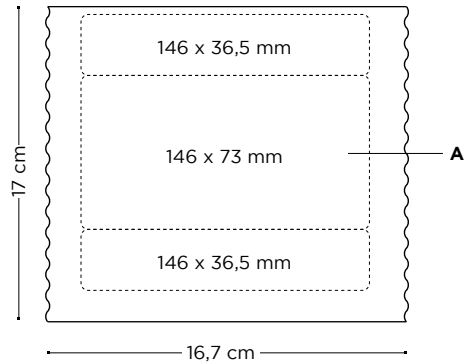

Price (€)

BIC® COMFORT 2 LADY	500-999	1000-2499	2500-4999	5000-9999	10000-24999	25000-49999
Shaver + Flow Pack						
<b>DG</b>	1,62	1,06	0,78	0,59	0,47	0,41
Shaver + Gel + Flow Pack						
<b>DG</b>	1,95	1,39	1,08	0,89	①	①

**Prices include fully personalised packaging in 4-colour process.** Le prix inclut l'emballage totalement personnalisé en quadrichromie. Los precios incluyen el envasado totalmente personalizado en cuatricromía. In den Preisen sind mit Vierfarbdruck voll personalisierte Verpackungen inbegriffen. I prezzi includono imballaggio completamente personalizzato con processo in quadricromia  
 ① Price under request. Prix sur demande. Precio bajo consulta. Preis auf Anfrage. Prezzi su richiesta.

#### CARTON BOX (SMALL)

**A DG:** full-colour

Shaver +  
Carton Box



Shaver + Gel +  
Carton Box

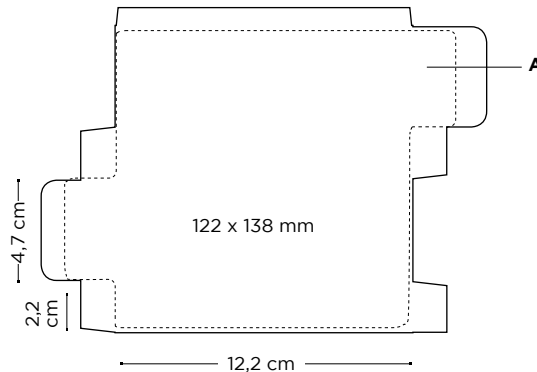

Price (€)

BIC® COMFORT 2 LADY	500-999	1000-2499	2500-4999	5000-9999	10000-24999	25000-49999
Shaver + Carton Box						
<b>DG</b>	2,54	1,51	0,98	0,72	0,54	0,46
Shaver + Gel + Carton Box						
<b>DG</b>	2,87	1,84	1,28	1,02	①	①

**Prices include fully personalised packaging in 4-colour process.** Le prix inclut l'emballage totalement personnalisé en quadrichromie. Los precios incluyen el envasado totalmente personalizado en cuatricromía. In den Preisen sind mit Vierfarbdruck voll personalisierte Verpackungen inbegriffen. I prezzi includono imballaggio completamente personalizzato con processo in quadricromia  
 ① Price under request. Prix sur demande. Precio bajo consulta. Preis auf Anfrage. Prezzi su richiesta.

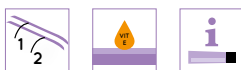



MOQ 500u.

BIC<sup>®</sup> PURE 3<sup>®</sup> LADY  
3132



59

FR > Tête fixe / Bande lubrifiante à l'aloë vera et à la vitamine E / 3 lames / Manche droit avec stries antidérapantes

ES > Cabezal fijo / Banda lubricante con aloë vera y vitamina E / 3 hojas / Mango recto con rebordes antideslizantes

DE > Fester Kopf / Gleitstreifen mit Aloe Vera und Vitamin E / 3 Klingen / Gerader Griff mit Antirutsch-Schlitz

IT > Testa rigida / Striscia lubrificante con aloë vera e vitamina E / 3 lame / Impugnatura dritta con rilievi antiscivolo

**Printing techniques:**

Techniques d'impression / Técnicas de impresión / Drucktechniken / Tecniche di stampa



(DG)  
DIGITAL



## Decoration:

Personnalisation / Personalización / Dekoration / Decorazione

### BIC® Pure 3® Lady

3132

#### FLOW PACK (SMALL)

**A DG:** full-colour

Shaver +  
Flow Pack



Shaver + Gel +  
Flow Pack

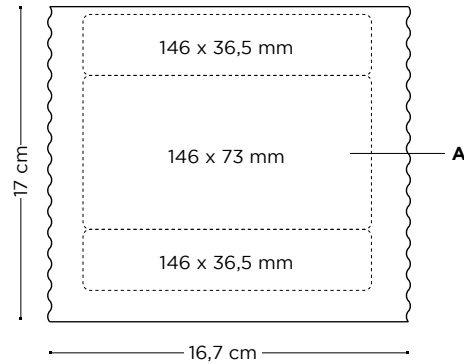

Price (€)

BIC® PURE 3® LADY	500-999	1000-2499	2500-4999	5000-9999	10000-24999	25000-49999
Shaver + Flow Pack						
<b>DG</b>	1,77	1,21	0,91	0,71	0,60	0,54
Shaver + Gel + Flow Pack						
<b>DG</b>	2,10	1,54	1,21	1,01	①	①

**Prices include fully personalised packaging in 4-colour process.** Le prix inclut l'emballage totalement personnalisé en quadrichromie. Los precios incluyen el envasado totalmente personalizado en cuatricromía. In den Preisen sind mit Vierfarbdruck voll personalisierte Verpackungen inbegriffen. I prezzi includono imballaggio completamente personalizzato con processo in quadricromia  
① Price under request. Prix sur demande. Precio bajo consulta. Preis auf Anfrage. Prezzi su richiesta.

#### CARTON BOX (SMALL)

**A DG:** full-colour

Shaver +  
Carton Box



Shaver + Gel +  
Carton Box

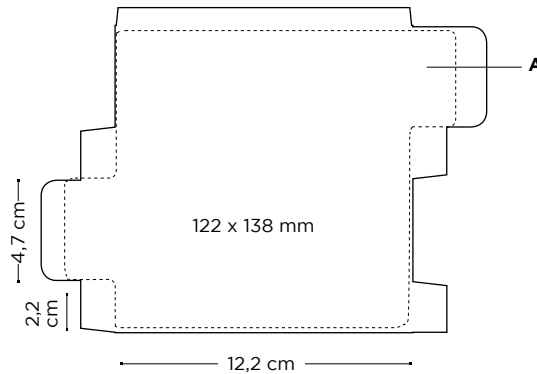

Price (€)

BIC® PURE 3® LADY	500-999	1000-2499	2500-4999	5000-9999	10000-24999	25000-49999
Shaver + Carton Box						
<b>DG</b>	2,69	1,66	1,11	0,84	0,67	0,59
Shaver + Gel + Carton Box						
<b>DG</b>	3,02	1,99	1,41	1,14	①	①

**Prices include fully personalised packaging in 4-colour process.** Le prix inclut l'emballage totalement personnalisé en quadrichromie. Los precios incluyen el envasado totalmente personalizado en cuatricromía. In den Preisen sind mit Vierfarbdruck voll personalisierte Verpackungen inbegriffen. I prezzi includono imballaggio completamente personalizzato con processo in quadricromia  
① Price under request. Prix sur demande. Precio bajo consulta. Preis auf Anfrage. Prezzi su richiesta.

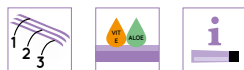

MADE IN EUROPE



MADE IN GREECE



MOQ 500u.

**BIC® SOLEIL® BELLA® LADY**  
3133



86

FR > 4 lames mobiles / Tête pivotante / Bande lubrifiante au lait de coco / Grande barre de protection / Manche ergonomique incurvé avec zone de préhension Soft Grip

ES > 4 hojas móviles / Cabezal pivotante / Banda lubricante con leche de coco / Gran barra de protección / Mango ergonómico con agarre de goma

DE > 4 bewegliche Klingen / Beweglicher Kopf / Gleitstreifen mit Kokosnussmilch / Großer Schutzstreifen / Komfortabler, geschwungener Soft-Griff

IT > 4 lame mobili / Testa pivotante / Striscia lubrificante con latte di cocco / Ampia barretta di sicurezza / Impugnatura comoda e curva con gomma antiscivolo



**Printing techniques:**

Techniques d'impression / Técnicas de impresión / Drucktechniken / Tecniche di stampa



(DG)  
DIGITAL

## Decoration:

Personnalisation / Personalización / Dekoration / Decorazione

### BIC® Soleil® Bella® Lady

3133

#### FLOW PACK (BIG)

**A DG:** full-colour

Shaver +  
Flow Pack



Shaver + Gel +  
Flow Pack

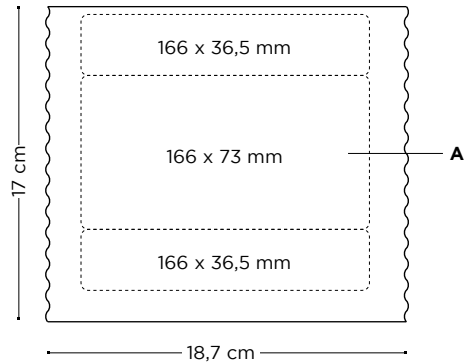

Price (€)

BIC® SOLEIL® BELLA® LADY	500-999	1000-2499	2500-4999	5000-9999	10000-24999	25000-49999
Shaver + Flow Pack						
<b>DG</b>	2,35	1,75	1,43	1,20	1,05	0,96
Shaver + Gel + Flow Pack						
<b>DG</b>	2,68	2,08	1,73	1,50	①	①

**Prices include fully personalised packaging in 4-colour process.** Le prix inclut l'emballage totalement personnalisé en quadrichromie. Los precios incluyen el envasado totalmente personalizado en cuatricromía. In den Preisen sind mit Vierfarbdruck voll personalisierte Verpackungen inbegriffen. I prezzi includono imballaggio completamente personalizzato con processo in quadricromia  
 ① Price under request. Prix sur demande. Precio bajo consulta. Preis auf Anfrage. Prezzi su richiesta.

#### CARTON BOX (BIG)

**A DG:** full-colour

Shaver +  
Carton Box



Shaver + Gel +  
Carton Box

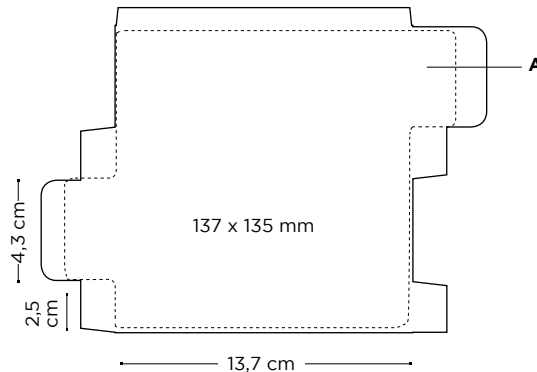

Price (€)

BIC® SOLEIL® BELLA® LADY	500-999	1000-2499	2500-4999	5000-9999	10000-24999	25000-49999
Shaver + Carton Box						
<b>DG</b>	3,44	2,28	1,68	1,37	1,15	1,04
Shaver + Gel + Carton Box						
<b>DG</b>	3,77	2,61	1,98	1,67	①	①

**Prices include fully personalised packaging in 4-colour process.** Le prix inclut l'emballage totalement personnalisé en quadrichromie. Los precios incluyen el envasado totalmente personalizado en cuatricromía. In den Preisen sind mit Vierfarbdruck voll personalisierte Verpackungen inbegriffen. I prezzi includono imballaggio completamente personalizzato con processo in quadricromia  
 ① Price under request. Prix sur demande. Precio bajo consulta. Preis auf Anfrage. Prezzi su richiesta.



**BAGS**

**288** BIC® Drawstring Backpack

**290** BIC® Classic Backpack

**292** BIC® Multi-Use Pouch





**BIC**® **B a g s**

288 — 293

3450



FR > Anse avec détail en PU  
 Etiquette BIC® porte-nom  
 Fermeture-éclair réfléchissante décorative  
 Forro interior con el logo BIC®  
 Partie en maille au dos du sac  
 Logo BIC® en silicone

ES > Asa con contraste de PU  
 Etiqueta BIC® para el nombre  
 Cremallera con banda reflectante decorativa  
 Doublure avec logo BIC®  
 Panel de malla adicional en la parte trasera  
 Logo BIC® de silicona

DE > Tragegriff mit kontrastierendem PU-Element  
 BIC®-Namensschild  
 Dekorativer, reflektierender Reißverschluss  
 Futter mit BIC®-Logo  
 Netzeinsatz auf der Rückseite  
 BIC®-Logo aus Silikon

IT > Maniglia con inserti in PU  
 Targhetta portanome con logo BIC®  
 Cerniera riflettente decorativa  
 Fodera con logo  
 Pannello a rete aggiuntivo sul retro  
 Logo BIC® in silicone

## MOQ 25u.

### Decoration:

Personnalisation / Personalización / Dekoration / Decorazione

### BIC® DRAWSTRING BACKPACK

3450

**A SP:** max. 2 col.

**B OT:** 4-colour process

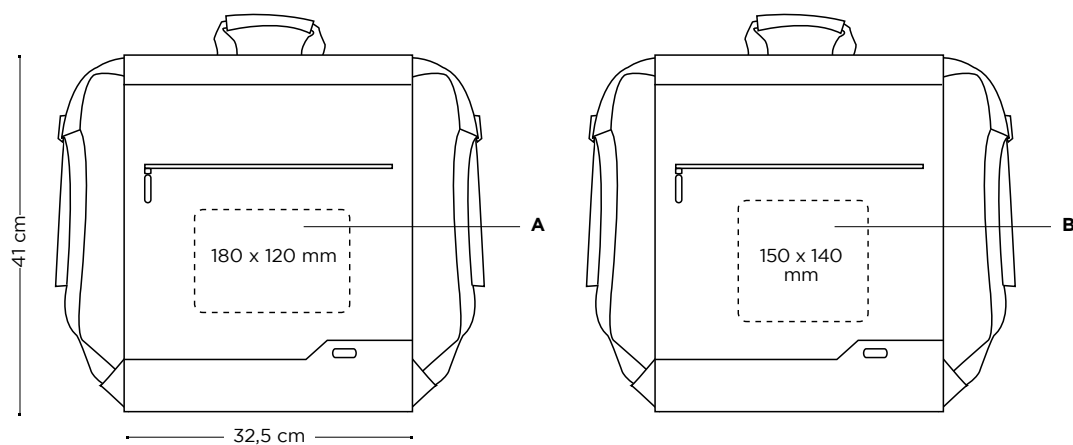

	Price (€)						
<b>BIC® DRAWSTRING BACKPACK</b>	25-49	50-99	100-249	250-499	500-999	1000-2499	2500-4999
3450							
<b>SP</b>	9,99	9,59	9,21	8,84	8,49	①	①
<b>OT</b>	-	-	-	-	9,42	①	①

**Additional charges:** coûts supplémentaires: / cargos adicionales: / aufpreise: / costi aggiuntivi:

<b>SP</b>	1,27	1,05	0,87	①	①	①	①
-----------	------	------	------	---	---	---	---

**SP: prices include 1 colour in 1 position** SP: Les prix incluent 1 couleur sur 1 emplacement. SP: precios incluyen 1 color en una posición SP: 1 Farbe auf 1 Position in den Preisen inbegriffen SP: i prezzi includono 1 colore in 1 posizione

**OT: prices include 4-colour process imprint** OT: Les prix incluent l'impression en quadrichromie. OT: los precios incluyen una impresión en cuatricromía OT: Vierfarbdruck in den Preisen inbegriffen OT: i prezzi includono la stampa con processo in quadricromia

① Price under request. Prix sur demande. Precio bajo consulta. Preis auf Anfrage. Prezzi su richiesta

### Printing techniques:

Techniques d'impression / Técnicas de impresión / Drucktechniken / Tecniche di stampa



(SP)  
SCREEN  
PRINTING



(OT)  
OFFSET  
TRANSFER

### External packaging:

Emballage externe / Envasado exterior / Außenverpackung / Imballaggio esterno



**50 ± 6,8 Kg**

### Check out the video

Regardez la video / Mira el video / Produktvideo / Guarda il video



3451



12

03

59

25

02

BIC® Bags • BACKPACKS



Padded pocket for 15 inch laptops and useful organizer

BIC® name tag

Decorative reflective zipper

Diamond pattern

silicone BIC® logo

Q 25%

Lining with BIC® logo

Useful strap for placing on a trolley

FR > Poche rembourrée et organisateur très utile  
Etiquette BIC® porte-nom  
Fermeture-éclair réfléchissante décorative  
Motifs en forme de losanges  
Doublure avec logo BIC®  
Logo BIC® en silicone  
Sangle très pratique pour suspendre le sac à un chariot

ES > Bolsillo acolchado y práctico organizador  
Etiqueta BIC® para el nombre  
Cremallera con banda reflectante decorativa  
Patrón en forma de diamante  
Forro interior con el logo BIC®  
Logo BIC® de silicona  
Práctica correa para ponerla en una trolley

DE > Gepolsterte Tasche und praktischer Organizer  
BIC®-Namensschild  
Dekorativer, reflektierender Reißverschluss  
Diamantmuster  
Futter mit BIC®-Logo  
BIC®-Logo aus Silikon  
Praktisches Band zur Befestigung am Trolley

IT > Tasca imbottita e utile organizer  
Targhetta portanome con logo BIC®  
Cerniera riflettente decorativa  
Motivo a rombi  
Fodera con logo  
Logo BIC® in silicone  
Cinghie per il fissaggio su un trolley

## MOQ 25u.

### Decoration:

Personnalisation / Personalización / Dekoration / Decorazione

### BIC® CLASSIC BACKPACK

3451

**A SP:** max. 2 col.

**B OT:** 4-colour process

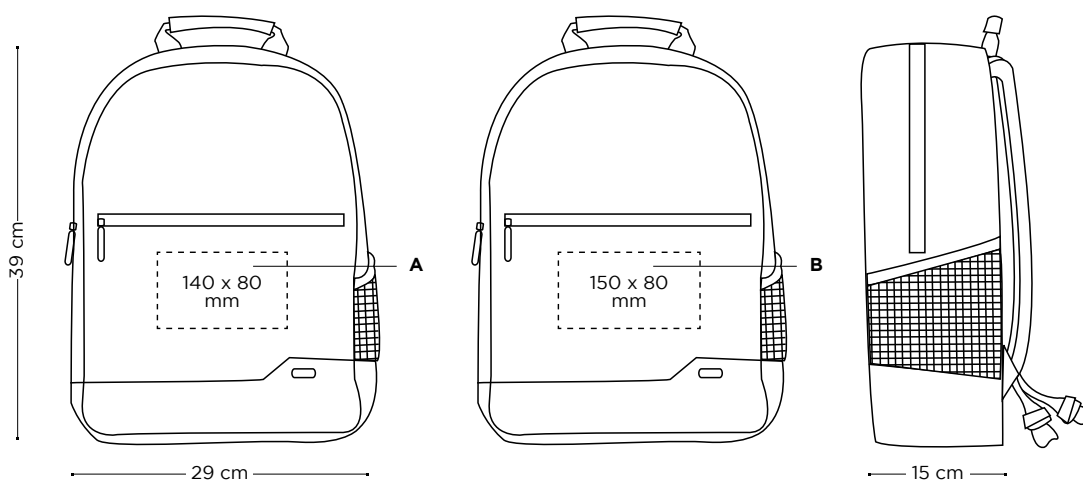

	Price (€)						
BIC® CLASSIC BACKPACK	25-49	50-99	100-249	250-499	500-999	1000-2499	2500-4999
3451							
<b>SP</b>	19,97	19,17	18,40	17,66	16,95	①	①
<b>OT</b>	-	-	-	-	17,88	①	①

**Additional charges:** coûts supplémentaires: / cargos adicionales: / aufpreise: / costi aggiuntivi:

<b>SP</b>	1,27	1,05	0,87	①	①	①	①
-----------	------	------	------	---	---	---	---

**SP: prices include 1 colour in 1 position** SP: Les prix incluent 1 couleur sur 1 emplacement. SP: precios incluyen 1 color en una posición SP: 1 Farbe auf 1 Position in den Preisen inbegriffen SP: i prezzi includono 1 colore in 1 posizione

**OT: prices include 4-colour process imprint** OT: Les prix incluent l'impression en quadrichromie. OT: los precios incluyen una impresión en cuatricromía OT: Vierfarbdruck in den Preisen inbegriffen OT: i prezzi includono la stampa con processo in quadricromia

① Price under request. Prix sur demande. Precio bajo consulta. Preis auf Anfrage. Prezzi su richiesta

### Printing techniques:

Techniques d'impression / Técnicas de impresión / Drucktechniken / Tecniche di stampa



(SP)  
SCREEN  
PRINTING



(OT)  
OFFSET  
TRANSFER

### External packaging:

Emballage externe / Envasado exterior / Außenverpackung / Imballaggio esterno



**25 ± 8,7 Kg**

### Check out the video

Regardez la vidéo / Mira el vídeo / Produktvideo / Guarda il video



3452



FR > Poche rembourrée et organisateur très utile  
Etiquette BIC® porte-nom  
Fermeture-éclair réfléchissante décorative  
Motifs en forme de losanges  
Doublure avec logo BIC®  
Logo BIC® en silicone  
Sangle très pratique pour suspendre le sac à un chariot

ES > Bolsillo acolchado y práctico organizador  
Etiqueta BIC® para el nombre  
Cremallera con banda reflectante decorativa  
Patrón en forma de diamante  
Forro interior con el logo BIC®  
Logo BIC® de silicona  
Práctica correa para ponerla en un trolley

DE > Gepolsterte Tasche und praktischer Organizer  
BIC®-Namensschild  
Dekorativer, reflektierender Reißverschluss  
Diamantmuster  
Futter mit BIC®-Logo  
BIC®-Logo aus Silikon  
Praktisches Band zur Befestigung am Trolley

IT > Tasca imbottita e utile organizer  
Targhetta portanome con logo BIC®  
Cerniera riflettente decorativa  
Motivo a rombi  
Fodera con logo  
Logo BIC® in silicone  
Cinghia per il fissaggio su un trolley

MOQ 50u.

**Decoration:**

Personnalisation / Personalización / Dekoration / Decorazione

**BIC® MULTI-USE POUCH**

3452

**A SP:** max. 1 col.

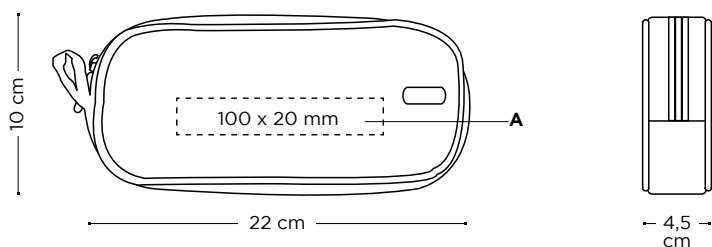

	Price (€)					
<b>BIC® MULTI-USE POUCH</b>	50-99	100-249	250-499	500-999	1000-2499	2500-4999
3452						
<b>SP</b>	5,54	5,32	5,10	4,90	①	①

**SP: prices include 1 colour in 1 position** Le prix inclut l'emballage totalement personnalisé en quadrichromie. Los precios incluyen el envasado totalmente personalizado en cuatricromía. In den Preisen sind mit Vierfarbdruck voll personalisierte Verpackungen inbegriffen. I prezzi includono l'imballaggio completamente personalizzato con processo in quadricromia

① Price under request. Prix sur demande. Precio bajo consulta. Preis auf Anfrage. Prezzi su richiesta

**Printing techniques:**

Techniques d'impression / Técnicas de impresión / Drucktechniken / Tecniche di stampa



(SP)  
SCREEN  
PRINTING

**External packaging:**

Emballage externe / Envasado exterior / Außenverpackung / Imballaggio esterno



**100** ± 5,8 Kg

**Check out the video**

Regardez la vidéo / Mira el vídeo / Produktvideo / Guarda il video



## **TECHNOLOGY**

**296** Mouse Pad

## **T'NB**

**297** T'NB Lumy Wireless Mouse  
& T'NB Lumy Wired Mouse

**298** T'NB Rainbow Mouse

**299** T'NB Stone Powerbank  
41000 mAh & 6600 mAh

**300** T'NB Ultra-Slim Powerbanks  
4000 mAh & MFI Adapter

**301** T'NB Slim Powerbank  
6000 mAh

## **SKROSS**

**302** SKROSS World To  
Europe USB

**303** SKROSS Pro Light USB

**304** SKROSS World Adapter  
MUV USB



# Technology

294 — 304

15031



60%

MOQ 50u.

**Decoration:**

Personalisation / Personalización / Dekoration / Decorazione.

**MOUSE PAD**

15031

**A SU:** 4-colour process

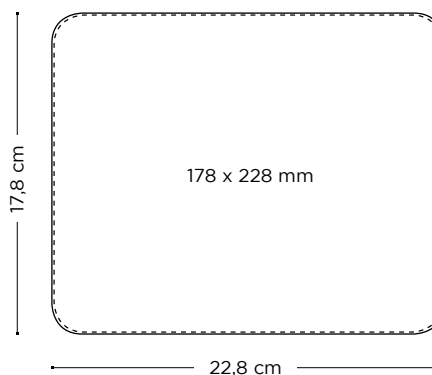

	Price (€)						
MOUSE PAD	50-99	100-249	250-499	500-999	1000-2499	2500-4999	5000-9999
15031							
<b>SU</b>	5,09	4,17	3,55	3,24	3,03	①	①

**Price includes digital imprint in sublimation.** Le prix inclut l'impression numérique par sublimation / El precio incluye impresión digital en sublimación / Preis inklusive Sublimations-Digitaldruck / Il prezzo include stampa digitale sublimatica.

① Price under request. Prix sur demande / Precio bajo consulta / Preis auf Anfrage / Prezzi su richiesta.

**Printing techniques:**

Techniques d'impression / Técnicas de impresión / Drucktechniken / Tecniche di stampa.



(SU) SUBLIMATION

**External Packaging:**

Emballage externe / Envasado exterior / Außenverpackung / Imballaggio esterno.



**200** ± 9 Kg



# LUMY WIRELESS MOUSE & LUMY WIRED MOUSE



MOQ 10u.



Enjoy the relaxing effect of the changing colour LED backlight



09697.10



09666.10

Cord length 135 cm

## Decoration:

Personnalisation / Personalización / Dekoration / Decorazione.

## T'nB® LUMY WIRELESS MOUSE & T'nB® LUMY WIRED MOUSE

09697 / 09666

**A BP:** front, full-colour

**B BPT:** front, full-colour

**C PD:** front, max. 1 colour

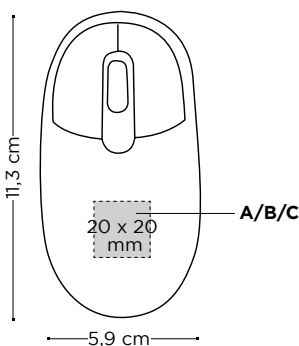

FR > Profitez de l'effet relaxant du rétro-éclairage LED à couleur changeante  
 LED à couleur changeante  
 ES > Disfruta el relajante efecto de luz LED cambiante retroiluminada  
 cambiante retroiluminada  
 DE > Genießen Sie den entspannenden Effekt der wechselnden LEDH intergrundbeleuchtung  
 IT > Goditi il rilassante effetto del LED cangiante retroilluminato

09697

"Light therapy" wireless mouse with 8 changing colors that will relax you even at work.

In order to optimize the battery life, the mouse has an ON/OFF button and an automatic standby mode.

FR > Souris sans fil type "luminothérapie" qui grâce à ses 8 couleurs changeante vous détendra même au travail. Dans un soucis d'économie et d'optimisation de la durée d'utilisation de la pile, la souris dispose d'un bouton ON/OFF et un mode veille automatique.  
 ES > Ratón inalámbrico tipo "luminoterapia" que gracias a sus 8 colores cambiantes te relajará incluso en el trabajo. Para economizar y optimizar la duración de la batería, el ratón tiene un botón de ON/OFF y un modo de espera automático.  
 DE > "Lichttherapie" mit acht wechselnden Farben für eine entspannte Atmosphäre bei der Arbeit. Zur Optimierung der Batterie mit EIN/ AUS-Schalter und automatischer Standby-Funktion.  
 IT > Mouse wireless "Luminoterapia" con 8 colori cangianti per rilassarvi anche al lavoro. Per ottimizzare la durata della batteria, il mouse è dotato di un pulsante ON/OFF e una modalità di standby.

09666

Wired 1000 DPI optical mouse with the relaxing effect of light with changing backlit colour: LED with 7 automatic colours. Two buttons and click wheel.

Compatible with PC/MAC®. USB connectivity.

FR > Souris optique avec câble de 1000 DPI et effet relaxant câble à la lumière LED changeante avec 7 couleurs en alternance. Deux boutons et une molette avec clic. Compatible avec PC/MAC®. Connexion USB.  
 ES > Ratón óptico con cable de 1000 dpi y con un efecto relajante de luz LED cambiante que alterna 7 colores. Dos botones y rueda con click. Compatible con PC/MAC®. Conexión USB.  
 DE > 1000 dpi optische, kabelgebundene Maus mit entspannendem Hintergrund- Lichteffect: LEDs mit 7 automatisch wechselnden Farben. Zwei Tasten und ein Klickrad. Kompatibel für PC/MAC®. USB-Schnittstelle.  
 IT > Mouse ottico con cavo da 1000 dpi, con un rilassante effetto di luce LED che cambia alternando 7 colori. Due pulsanti e rotellina con click. Compatible con PC/MAC®. Collegamento USB.

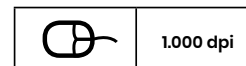
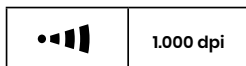

## Printing techniques:

Techniques d'impression / Técnicas de impresión / Drucktechniken / Tecniche di stampa.



(BP) britePix™



PAD PRINTING



## Packaging:

Emballage / Envasado / Verpackung / Imballaggio.



09697

09666

## External Packaging:

Emballage externe / Envasado exterior / Außenverpackung / Imballaggio esterno.



100 ± 14 Kg

## Check out the video

Regardez la video / Mira el vídeo / Produktvideo / Guarda il video.



MOQ 10u.



.20

Fun and coloured wired mouse

FR > Souris fun et coloré avec cable  
 ES > Divertido y colorido ratón con cable  
 DE > Farbenfrohe kabelgebundene Maus  
 T > Mouse con cavo divertente e colorat



.32



.30

**Decoration:**

Personnalisation / Personalización / Dekoration / Decorazione.

**T'nB® RAINBOW MOUSE**

09699

**A BP:** box front, full-colour

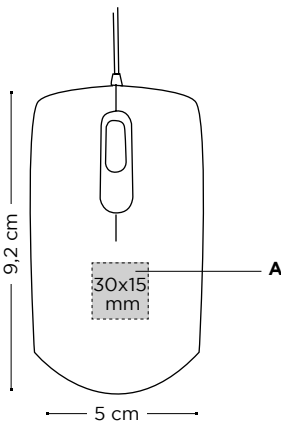

This 1000 dpi colorful mouse features 2 silent click buttons and a clickable scroll. Enjoy a fun two colors design and USB cable matching the mouse body color.

FR > Cette souris colorée, 1000 dpi, est dotée de 2 boutons et scroll cliquable. Profitez d'un design fun et bicolore et un cable USB de la même couleur que le corps de la souris.

ES > Este ratón colorido de 1000 ppp cuenta con 2 botones clic silenciosos y un scroll en el que se puede hacer clic. Disfruta de un divertido diseño de dos colores y un cable USB que combina con el color del cuerpo del ratón.

DE > Farbenfrohe 1000 dpi-Maus mit zwei leisen Schaltflächen und klickbarem Scrollrad. Genießen Sie das frische zweifarbige Design mit farblich passendem USBKabel.

IT > Il colorato mouse da 1000 dpi ha 2 pulsanti silenziosi e uno scroll su cui è possibile cliccare. Ha un divertente design bicolore e un cavo

**Printing techniques:**

Techniques d'impression / Técnicas de impresión / Drucktechniken / Tecniche di stampa.



(BP) britePix™



**Packaging:**

Emballage / Envasado / Verpackung / Imballaggio.



**External Packaging:**

Emballage externe / Envasado exterior / Außenverpackung / Imballaggio esterno.



100 ± 10 Kg

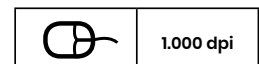

MOQ 10u.



09664 .31

Looks like a real stone

FR > Apparence comme une vraie pierre  
 ES > Parece una piedra real  
 DE > Sieht aus wie ein echter Stein  
 IT > Sembra una vera pietra

Velvet pouch included

FR > Pochette en velours incluse  
 ES > Bolsa de terciopelo incluida  
 DE > Samttasche inklusive  
 IT > Custodia in velluto inclusa



09665 .31

Includes micro USB cable

FR > Câble micro USB inclus  
 ES > Incluye cable USB  
 DE > Inklusive Mikro-USB-Kabel  
 IT > Cavo micro USB incluso

**Decoration:**

Personnalisation / Personalización / Dekoration / Decorazione.

**T'nB® STONE POWERBANK 4000 MAH**

09664

**A BP:** front, full-colour  
**B BPT:** front, full-colour

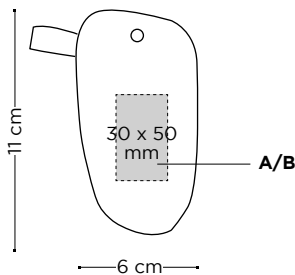

**T'nB® STONE POWERBANK 6600 MAH**

09665

**A BP:** front, full-colour  
**B BPT:** front, full-colour

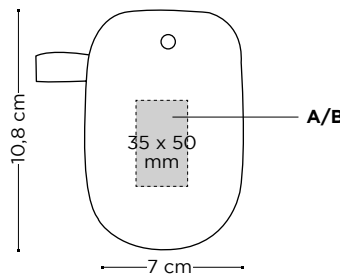

Compact power bank in the shape of a stone. Battery level is indicated with 4 lights. Includes micro USB cable.

FR > Batterie externe compacte en forme de pierre. Le niveau de charge est indiqué au moyen de 4 lumières. Câble micro USB inclus.

ES > Bateria externa compacta con forma de piedra. El nivel de carga se indica con 4 luces. Incluye cable micro USB.

DE > Kompakte Power-Bank in Form eines Steines. Der Batteriestand wird mit 4 Leuchten angezeigt. Inklusive Mikro-USB-Kabel.

IT > Batteria esterna compatta a forma di pietra. Il livello di carica viene indicato

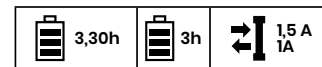

09664 09665

**Printing techniques:**

Techniques d'impression / Técnicas de impresión / Drucktechniken / Tecniche di stampa.



(BP) britePix™



**Packaging:**

Emballage / Envasado / Verpackung / Imballaggio.



**External Packaging:**

Emballage externe / Envasado exterior / Außenverpackung / Imballaggio esterno.



60 ± 8,6 Kg

**Check out the video**

Regardez la video / Mira el video / Produktvideo / Guarda il video.





# ULTRA-SLIM POWERBANKS 4000 mAh & MFI ADAPTER

MOQ 10u.

only 8 mm thickness!

FR > Seulement 8 mm d'épaisseur!  
ES > Sólo 8 mm de grosor!  
DE > Nur 8 mm dünn!  
IT > Solo 8 mm di spessore!



If you have iPhone® use this lightning adapter!

.10



Integrated USB cable

FR > Câble USB intégré  
ES > Cable USB integrado  
DE > integriertes USB-Kabel  
IT > Cavo USB integrato

.30

velvet pouch included

FR > Pochette en velours incluse  
ES > Bolsa de terciopelo incluida  
DE > Samttasche inklusive  
IT > Custodia in velluto inclusa

FR > Si vous possédez un iPhone® utilisez l'adaptateur Lightning.  
ES > En caso de iPhone® utiliza el adaptador Lightning.  
DE > Wenn Sie ein iPhone® nutzen, verbinden Sie einfach den beigefügten Lightning-Adapter.  
IT > Se hai un iPhone® utilizza l'adattatore Lightning in dotazione.

## Decoration:

Personalisation / Personalización / Dekoration / Decorazione.

## TnB® ULTRA-SLIM POWER BANK 4000 MFI

09701

A BP: front, full-colour

B BPT: front, full-colour

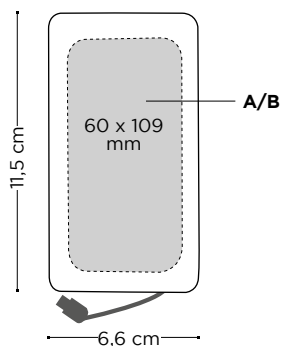

## TnB® ULTRA-SLIM POWERBANK 4000 mAh

09702

C BP: front, full-colour

D BPT: front, full-colour

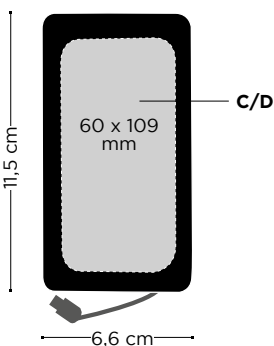

Ultra-slim power bank 4000 mAh with built in micro USB cable. This compact and slim power bank is easy to slip into your suitcase or your bag thanks to its 8 mm thickness. You can triple the autonomy of your smartphone depending on the model. Integrated micro USB cable so that you can recharge it wherever you are. Velvet pouch included.

FR > Batterie externe ultra plate 4000 mAh avec câble micro USB intégré. Cette batterie externe ultra plate et compacte se glissera facilement dans votre sac ou dans votre valise grâce à ses 8 mm d'épaisseur. Vous pouvez tripler l'autonomie de votre smartphone en fonction du modèle. De plus, grâce à son câble micro USB intégré, rechargez-la en un geste, où que vous soyez.

ES > Power bank ultra plano de 4000 mAh con cable micro USB integrado. Este power bank compacto cabe fácilmente en cualquier bolsa o maleta gracias a sus sólo 8 mm de grosor. Puedes llegar a triplicar la autonomía de tu smartphone dependiendo del modelo. Gracias a su cable micro USB integrado puedes recargarlo en cualquier parte.

DE > Ultradünne Power-Bank 4.000mAh mit eingebautem Mikro-USB-Kabel. Diese kompakte Power-Bank lässt sich dank ihrer schlanken 8mm-Dicke ganz leicht in Ihrem Koffer oder in Ihrer Tasche verstauen. Sie können die Leistung Ihres Smartphones, je nach Modell, verdreifachen. Darüber hinaus können Sie sie dank des integrierten Mikro-USB-Kabels überall wieder aufladen, wo auch immer Sie unterwegs sind.

IT > Caricatore portatile ultrasottile da 4000 mAh con cavo micro USB integrato. Puoi comodamente infilare questo caricatore portatile sottile e compatto nella tua valigia o nella tua borsa, grazie al suo spessore di soli 8 mm. Puoi arrivare a triplicare l'autonomia del tuo smartphone, a seconda del modello. Inoltre, grazie al suo cavo micro USB

## Printing techniques:

Techniques d'impression / Técnicas de impresión / Drucktechniken / Tecniche di stampa.



(BP) britePix™



## Packaging:

Emballage / Envasado / Verpackung / Imballaggio.



## External Packaging:

Emballage externe / Envasado exterior / Außenverpackung / Imballaggio esterno.

09701



40 ± 6,6 Kg

09702



40 ± 6,6 Kg



MOQ 10u.

only 15 mm thinness!

FR > Seulement 15 mm d'épaisseur!  
 ES > Sólo 15 mm de grosor!  
 DE > Nur 15 mm dünn!  
 ZIT > Solo 15 mm di spessore!



75%

USB cable +  
 micro USB integrated

FR > Pochette en velours incluse  
 ES > Bolsa de terciopelo incluida  
 DE > Samttasche inklusive  
 IT > Custodia in velluto inclusa

Velvet  
 pouch  
 included

.30

FR > Pochette en velours incluse  
 ES > Bolsa de terciopelo incluida  
 DE > Samttasche inklusive  
 IT > Custodia in velluto inclusa

**Decoration:**

Personnalisation / Personalización  
 / Dekoration / Decorazione.

**T'nB® SLIM POWER BANK 6000 mAh**

09703

**A BP:** front, full-colour

**B BPT:** front, full-colour

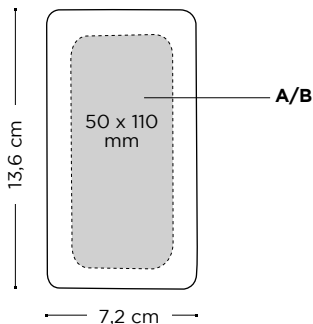

This compact and slim powerbank 6000 mAh is easy to slip into your suitcase or your bag thanks to its thinness of 15 mm. You can multiply by 4 the autonomy of your Smartphone (depending on the model). Moreover, thanks to its integrated USB cable + micro USB, recharge the powerbank and your device wherever you are. If you have an iPhone®, there is also a USB port available.

FR > Cette batterie nomade slim et compacte 6000 mAh se glissera facilement dans votre sac grâce à sa finesse de 15mm. Vous pouvez quadrupler l'autonomie de votre Smartphone (en fonction du modèle). De plus, grâce à son câble USB + micro USB intégré, rechargez aussi bien la batterie nomade que votre Smartphone et ce où que vous soyez. Si vous possédez un iPhone, utilisez le port USB présent sur le côté.

ES > Este compacto y delgado powerbank de 6000 mAh es fácil de guardar en su maleta o en su bolso gracias a su delgadez de 15 mm. Puede multiplicar por 4 la autonomía de su Smartphone (según el modelo). Además, gracias a su cable USB + micro USB integrado, puedes recargar el dispositivo donde quiera que estés. Si tienes un iPhone, también hay un puerto USB disponible.

DE > Diese kompakte und 15 mm dünne 6000 mAh-Powerbank passt problemlos in Ihren Koffer oder Ihre Handtasche. Sie können damit die Autonomie Ihres Smartphones (je nach Modell) vervierfachen. Darüber hinaus können Sie die Powerbank und Ihr Smartphone über das integrierte USB- und Micro-USB-Kabel überall aufladen. Für iPhone-Besitzer gibt es auch einen speziellen USB-Port.

IT > Questo caricatore portatile sottile e compatto da 6000 mAh è facile da mettere in valigia o in borsa, grazie al suo spessore di soli 15 mm. È possibile quadruplicare l'autonomia del proprio smartphone (a seconda del modello). Inoltre, grazie al suo cavo USB + micro USB integrato, puoi ricaricare il caricatore portatile e il tuo dispositivo ovunque tu sia. Se hai un iPhone,

**Printing techniques:**

Techniques d'impression / Técnicas de impresión / Drucktechniken / Tecniche di stampa.



(BP) britePix™



**Packaging:**

Emballage / Envasado / Verpackung / Imballaggio.



**External Packaging:**

Emballage externe / Envasado exterior / Außenverpackung / Imballaggio esterno.



40 ± 9,2 Kg



**MOQ 10u.**



*The whole world at home in Europe!*

FR > ¡El mundo entero en casa, en Europa!  
ES > The whole world at home in Europe!  
DE > Die ganze Welt in Europa zu Hause!  
IT > Tutto il mondo a casa, in Europa!



.10

**Decoration:**

Personnalisation / Personalización / Dekoration / Decorazione.

**WORLD TO EUROPE USB**

\*USB 09677

**A PD:** max. 2 col.

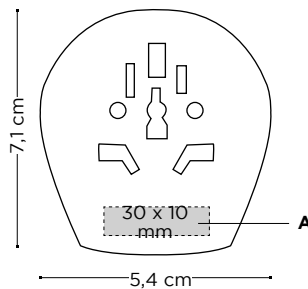

An easy, reliable connection to the European standard plug for devices from all over the world, with built-in USB charger that can be used at the same time. Suitable for equipment with earthed and unearthed plugs (2 and 3 poles) and USB devices. Receptacles for: Switzerland, Italy, Australia/China, UK, USA/Japan and Brazil.

FR > Connexion facile et fiable à la prise standard européenne pour les dispositifs du monde entier, avec chargeur USB incorporé pouvant être utilisé simultanément. Convient pour des équipements avec des prises raccordées ou non à la terre (à 2 et 3 pôles) et des dispositifs USB. Entrées pour : Suisse, Italie, Australie/Chine, Royaume-Uni, USA/Japon et Brésil.

ES > Conexión fácil y fiable al enchufe estándar europeo para dispositivos de todo el mundo, con cargador USB integrado que se puede usar al mismo tiempo. Apto para equipamiento con enchufes con y sin toma de tierra (de 2 y 3 polos) y dispositivos USB. Entradas para Suiza, Italia, Australia/China, Reino Unido, EEUU/Japón y Brasil.

DE > Zuverlässige und einfache Verbindung für Geräte aus der ganzen Welt mit dem europäischen Normstecker, inkl. integriertem USB-Ladegerät für zeitgleiche Verwendung. Geeignet für geerdete und ungeerdete Stecker (2- und 3-polig) sowie USB-Geräte. Steckdoseneingang für: Schweiz, Italien, Australien/China, UK, USA/Japan und Brasilien.

IT > Collegarsi alle prese standard europee con dispositivi internazionali è semplice e affidabile; con caricabatterie USB integrato, che puoi usare contemporaneamente. Adatto per apparecchiature dotate di spine con e senza messa a terra (a 2 e 3 poli) e dispositivi USB. Spine per Svizzera, Italia, Australia/Cina, Regno Unito, USA/Giappone e Brasile.

**Printing techniques:**

Techniques d'impression / Técnicas de impresión / Drucktechniken / Tecniche di stampa.



PAD PRINTING

**Packaging:**

Emballage / Envasado / Verpackung / Imballaggio.



**External Packaging:**

Emballage externe / Envasado exterior / Außenverpackung / Imballaggio esterno.



50 ± 3 Kg

**Check out the video**

Regardez la video / Mira el video / Produktvideo / Guarda il video.





**MOQ 10u.**



The smallest 3-pole world travel adapter with built-in USB charger!

FR > Le plus petit des adaptateurs de voyage à 3 pôles, et avec chargeur USB intégré !

ES > El adaptador de viaje de 3 polos más pequeño icon cargador USB integrado!

DE > Der kleinste 3-polige Welt-Reiseadapter mit integriertem USBLadegerät!

IT > Il più piccolo adattatore da viaggio a 3 poli, con caricabatterie US integrato!



120%



**Decoration:**

Personnalisation / Personalización / Dekoration / Decorazione.

.10

**PRO LIGHT USB**

\*USB 09678

**A PD:** max. 2 col.

**B PD:** max. 2 col.

**C PD:** max. 2 col.

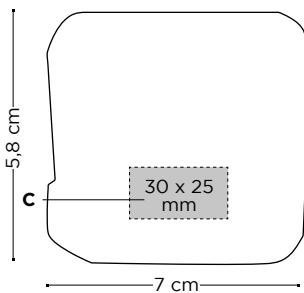
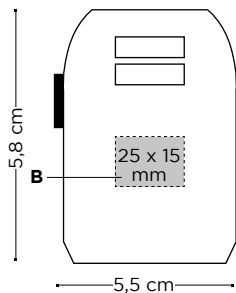
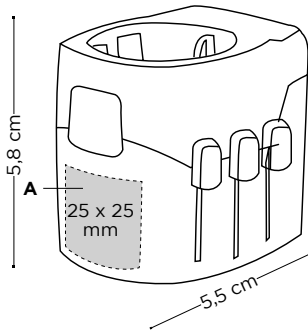

Ultra compact 3-pole travel adapter that can be used in over 100 countries and functions as both a travel plug and USB charger for travellers from Europe. Suitable for connecting powerful devices such as laptops or travel hairdryers and charging two smartphones via USB at the same time.

FR > Adaptateur de voyage à 3 pôles ultracompact pouvant être utilisé dans plus de 100 pays et servant aussi bien de prise de voyage que de chargeur USB pour les voyageurs européens. Convient pour connecter des dispositifs puissants tels que portables ou sèchecheveux de voyage, et pour charger deux smartphones en même temps via USB.

ES > Adaptador de viaje de 3 polos ultracompacto que puede usarse en más de 100 países y que funciona tanto como enchufe de viaje, como cargador USB para viajeros europeos. Apto para conectar dispositivos potentes como portátiles o secadores de pelo de viaje y cargar via USB dos smartphones al mismo tiempo.

DE > Ultra kompakter 3-poliger Reiseadapter für über 100 Länder, der sowohl als Reisestecker, als auch als USB-Ladegerät für Reisende aus Europa dient. Geeignet, um ein leistungsstarkes Gerät wie Laptop oder Reisehaartrockner anzuschließen und gleichzeitig zwei Smartphones über USB zu laden.

IT > Adattatore da viaggio a 3 poli ultracompatto, utilizzabile in più di 100 paesi, funziona sia come spina da viaggio, sia come caricabatterie USB per i viaggiatori europei. Adatto per collegare alla corrente dispositivi potenti come notebook o asciugacapelli viaggio e, allo stesso tempo, ricaricare tramite USB due smartphone.

**Printing techniques:**

Techniques d'impression / Técnicas de impresión / Drucktechniken / Tecniche di stampa.



PAD PRINTING

**Packaging:**

Emballage / Envasado / Verpackung / Imballaggio.



**External Packaging:**

Emballage externe / Envasado exterior / Außenverpackung / Imballaggio esterno.



50 ± 7,2 Kg



MOQ 10u.



120%



.10

**Decoration:**

Personnalisation / Personalización / Dekoration / Decorazione.

**WORLD ADAPTER MUV USB**

\*USB 09474

**A PD:** max. 2 col.

**B PD:** max. 2 col.

**C PD:** max. 2 col.

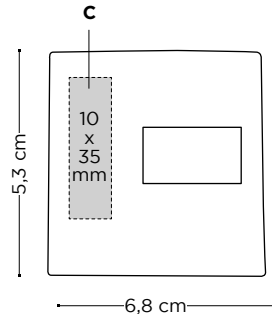
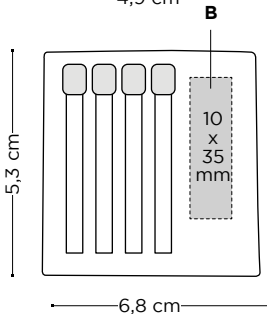
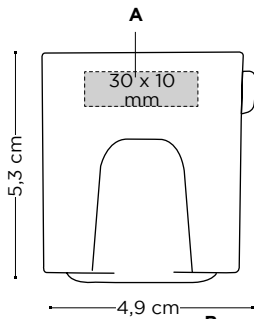

This innovative 2-pole adapter can be used in over 220 countries and functions as both as travel plug and USB charger. It can connect simultaneously one unearthed 2-pole-plug and two USB devices with a rich charging output of 2400 mA shared.

FR > Cet adaptateur innovant à 2 pôles peut être utilisé dans plus de 220 pays et sert à la fois d'adaptateur de voyage et de chargeur USB. Grâce à la grande capacité de charge de sa batterie (2400 mA), vous pouvez brancher en même temps un appareil équipé d'une prise à 2 pôles et deux appareils USB.

ES > Este innovador adaptador de 2 polos puede usarse en más de 220 países y funciona como enchufe de viaje y como cargador USB a la vez. Puede conectar simultáneamente un enchufe de 2 polos sin toma de tierra y dos dispositivos USB gracias a su alta capacidad de carga de 2400 mA.

DE > Dieser innovative 2-polige Adapter kann in über 220 Ländern als Reiseadapter und USB-Ladegerät eingesetzt werden. Er stellt 2400 mA Ladepower bereit und kann damit zeitgleich zwei USB-Geräte aufladen, und einen ungeerdeten 2-poligen Stecker verbinden.

IT > Questo innovativo adattatore a due poli può essere usato in più di 220 paesi e funziona come caricatore da viaggio e caricatore USB contemporaneamente. Con una carica di 2400 mA permette di collegare simultaneamente una spina a 2 poli e due dispositivi USB.

**Printing techniques:**

Techniques d'impression / Técnicas de impresión / Drucktechniken / Tecniche di stampa.



PAD PRINTING

**Packaging:**

Emballage / Envasado / Verpackung / Imballaggio.



**External Packaging:**

Emballage externe / Envasado exterior / Außenverpackung / Imballaggio esterno.



50 ± 11,8 Kg



# Packaging

305 — 310

**PACKAGING**

**306** BIC® Packaging

**BIC** ECO SLEEVE *New!*

985240

Special recycled sleeve for all BIC® writing instruments except graphite pencils.

Pochette spéciale recyclée pour tous les instruments d'écriture BIC® à l'exception des crayons papier.

Funda especial reciclada para todos los instrumentos de escritura BIC excepto los lápices de grafito.

Spezieller recycelter Schaft für alle BIC®

Schreibgeräte ausgenommen Bleistifte.

Astuccio riciclato opzionale per tutti gli strumenti di scrittura BIC eccetto le matite.



Price (€)  
0,22



RECYCLED CARDBOARD



MADE IN SPAIN



Special packaging for pens with clip printed:

**BIC** MEDIA CLIC

**BIC** WIDE BODY

**BIC** CLIC STIC

**BIC** ATLANTIS

**BIC** SUPER CLIP

**BIC** FINE STYLE

Check out Treedom initiative:



**BIC** WINDOW BOX *New!*

985241

Premium design packaging for all BIC® writing instruments except graphite pencils.

Emballage design haut de gamme pour tous les instruments d'écriture BIC® à l'exception des crayons papier.

Envasado de diseño premium para todos los instrumentos de escritura BIC® excepto los lápices de grafito. Premium-Designverpackung für alle BIC® Schreibgeräte ausgenommen Bleistifte.

Astuccio dal design premium adatto a tutti gli strumenti di scrittura BIC® eccetto le matite.



www.fsc.org



MADE IN SPAIN



Special packaging for:

**BIC** METAL PENS

Check out Treedom initiative:



Price (€)  
1,30

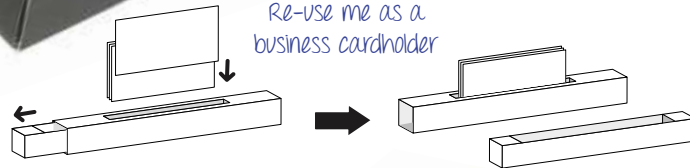

**BIC** PLASTIC POUCH *New!*

985242

Special design for this packaging which fits in any writing instruments and for 3 graphite pencils.

Design spécial pour cet emballage qui s'adapte à tous les instruments d'écriture et pour 3 crayons papier.

Diseño especial para este envasado que encaja con todos los instrumentos de escritura BIC y los 3 lápices de grafito.

Ein speziell für diese Verpackung entworfenes Design, das Platz für jedes Schreibgerät sowie drei Bleistifte bietet.

Design special per questa confezione adatta per ogni strumento di scrittura e per 3 matite.



www.fsc.org



RECYCLABLE PLASTIC



MADE IN SPAIN

Use me as bookmark



Price (€)  
0,41

**BIC MARKING SET** *New!*

985243

Packaging designed for all types of markers products.

Emballage conçu pour tous les types de stylos marqueurs.

Envasado diseñado para todo tipo de marcadores.

Die Verpackung wurde für alle Arten von Markern entworfen.

Confezione adatta a ogni marker.

Price (€)
0,65



*Special packaging for pens with clip printed:*

- 3 BRITELINER
- 3 *Velleda* GRIP
- 3 MARK-IT
- 4 *Velleda* FINE



**BIC GIFT BOX** *New!*

985241

Special set of notebooks and writing instruments.

Set spécial pour cahiers et instruments d'écriture.

Envasado diseñado para todo tipo de marcadores.

Ein Spezialset bestehend aus Notizblöcken und Schreibgeräten.

Confezione opzionale per set notebook e strumenti di scrittura.

Price (€)

A5	2,05
A6	1,90



*Special packaging for Dual Notebook A5 & A6 and:*

- 4-COLOURS (SP)
- MEDIA CLIC (SP)
- SUPER CLIP (SP)



**BIC** CELLO WRAP

971634 - 971635 - 971636 - 971637

Packaging to wrap in a tough and transparent plastic material.

Emballage enveloppe en matière plastique résistante et transparente  
 Envasado envuelto en material plástico y transparente.  
 Verpackung für das Einwickeln mit einem widerstandsfähigen und transparenten Kunststoff.

Confezione in resistente plastica trasparente.

Price (€)

1 unit - 971634	0,16
2 units - 971635	0,31
3 units - 971636	0,46
4 units - 971637	0,62

**Not available for graphite pencils or metal pens. Due to different printing processes, the imprint colours on pens and notepads may slightly differ.** Non disponible pour les crayons à papier ni pour les stylos en métal. En raison des différents procédés d'impression, les couleurs de marquage sur les stylos et les bloc-notes peuvent être légèrement différents / No disponible para lápices de grafito o bolígrafos de metal / Debido a los diferentes procesos de impresión, los colores de impresión en bolígrafos y blocs de notas pueden ser ligeramente diferentes / Nicht verfügbar für Druckbleistifte und Metallkugelschreiber. Aufgrund unterschiedlicher Druckverfahren kann es zuleichten Farbabweichungen auf den Kugelschreibern und Notizblöcken kommen / Non disponibile per matite in grafite né per penne metalliche. Per via delle differenti tecniche di stampa, i colori stampati sulle penne e sui blocchi note potrebbero risultare leggermente diversi.



**BIC** FROSTED POUCH (FOR 1 OR 2 ITEMS)

971640

Transparent packaging for 2 writing instruments.

Emballage transparent pour 2 instruments d'écriture.  
 Envasado transparente para dos instrumentos de escritura.  
 Transparente Verpackung für zwei Schreibgeräte.  
 Confezione trasparente per 2 strumenti di scrittura.

Price (€)  
0,79

**Additional imprint charge per colour & position**  
 SP 0,45

**Available for 1 or 2 (slim) BIC® writing instruments except: graphite pencils, BIC® Matic® Grip.** Disponible pour 1 ou 2 (slim) BIC® instruments d'écriture, à l'exception des crayons à papier et du BIC® Matic® Grip / Disponibile para 1 o 2 (slim) Instrumentos de Escritura BIC® / Verfügbar für 1 oder 2 (Slim) BIC® Schreibgeräte, ausgenommen Druckbleistift BIC® Matic® Grip / Disponibile per 1 o 2 strumenti di scrittura (sottili) BIC® eccetto: matite in grafite, BIC® Matic® Grip.

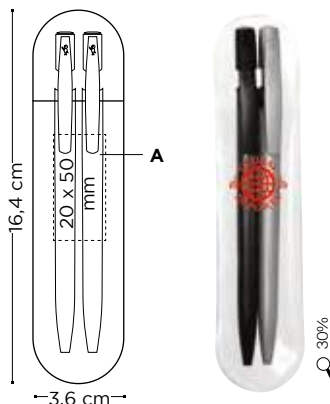

**A SP:** max. 1 col.



(SP) SCREEN PRINTING

Until stock lasts

**BIC** BLACK VELVET POUCH 1 ITEM

974216

Velvet exclusive packaging for 1 or 2 writing instruments. Especially indicated for metal pens.

Emballage exclusif en velours pour 1 ou 2 instruments d'écriture. Spécialement recommandé pour les stylos métal.  
 Envasado exclusivo de terciopelo para 1 o 2 instrumentos de escritura. Especialmente indicado para bolígrafos metálicos.  
 Exklusive Samtverpackung für ein oder zwei Schreibgeräte. Insbesondere für Metallkugelschreiber geeignet.  
 Esclusiva confezione in velluto per 1 o 2 strumenti di scrittura. Particolarmente indicata per penne in metallo.

Price (€)

1 item	0,47
for Set	0,79

**Available for all writing instruments, except graphite pencils.** Disponible pour tous les instruments d'écriture à l'exception des crayons à papier / Disponibile para todos instrumentos de escritura, excepto lápices de grafito / Verfügbar für alle Schreibgeräte, ausgenommen Druckbleistifte / Disponibile per tutti gli strumenti di scrittura eccetto matite in grafite.

**BIC** BLACK VELVET POUCH FOR SET

974217

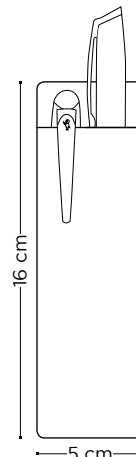
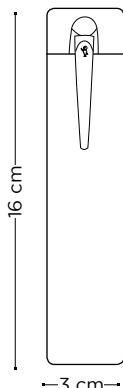

**BIC CARTON BLACK & SILVER COLOUR GIFT BOX**

974218

Box for all writing instruments, except graphite pencils.  
Boîte pour tous les instruments d'écriture, sauf les crayons papier.  
Caja para todos los instrumentos de escritura, excepto los lápices de grafito.  
Schachtel für alle Schreibgeräte ausgenommen Bleistifte.  
Scatoletta per tutti gli strumenti di scrittura, matite escluse.



Price (€)  
0,31

Until stock lasts

**BIC BLACK TWO PIECE GIFT BOX FOR 1 ITEM**

974214

Box for all writing instruments, except graphite pencils.

Boîte pour tous les instruments d'écriture, sauf les crayons papier.  
Caja para todos los instrumentos de escritura, excepto los lápices de grafito.  
Schachtel für alle Schreibgeräte ausgenommen Bleistifte.  
Scatoletta per tutti gli strumenti di scrittura, matite escluse.



Price (€)  
1,24

**Additional imprint charge per colour & position**

**SP** 0,45

**Available for all writing instruments, except graphite pencils.** Disponible pour tous les instruments d'écriture à l'exception des crayons à papier / Disponible para todos instrumentos de escritura, excepto lápices de grafito / Verfügbar für alle Schreibgeräte, ausgenommen Druckbleistifte / Disponibile per tutti gli strumenti di scrittura eccetto matite in grafite.

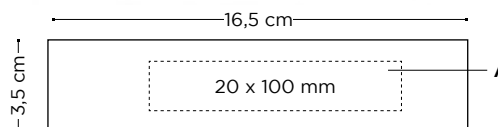

**A SP:** max. 1 col.



(SP) SCREEN PRINTING

Until stock lasts

**BIC SEE-THROUGH GIFT BOX (FOR 1 OR 2 ITEMS)**

974599

Box for all writing instruments, except graphite pencils, with special window.

Sac spécial pour tous les instruments d'écriture avec spécial personnalisation.  
Caja para todos los instrumentos de escritura, excepto los lápices de grafito, con ventana especial.  
Schachtel für alle Schreibgeräte ausgenommen Bleistifte, mit speziellem Sichtfenster.  
Scatoletta per tutti gli strumenti di scrittura, matite escluse, con finestrella.



Price (€)  
1,79

Until stock lasts

**BIC COTTON DRAWSTING POUCH**

974458

Special bag for all writing instruments with special personalization.

Sac cotton spécialment conçu pour tous les instruments d'écriture avec personnalisation spéciale.  
Bolsa especial para todos los instrumentos de escritura con personalización especial.  
Hochwertige Tasche für alle Schreibgeräte mit spezieller Personalisierung.  
Sacchetto opzionale per tutti gli strumenti di scrittura con personalizzazione su richiesta.

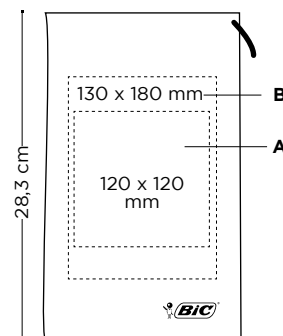

Price (€)

	50-99	100-249	250-499	500-999	1000-2499	2500-4999	5000-9999
Unimprinted	2,10	2,10	2,10	2,10	2,10	2,10	2,10
SP	-	-	-	2,97	2,82	2,76	2,75
OT	-	-	-	3,90	3,72	3,65	3,64

**Available for all writing instruments, except graphite pencils.** Disponible pour tous les instruments d'écriture à l'exception des crayons à papier / Disponible para todos instrumentos de escritura, excepto lápices de grafito / Verfügbar für alle Schreibgeräte, ausgenommen Druckbleistifte / Disponibile per tutti gli strumenti di scrittura eccetto matite in grafite.

**A SP:** max. 2 col.  
**A OT:** full-colour



(SP) SCREEN PRINTING



(OT) OFFSET TRANSFER

**COUNT BOX**

Small  
(for 25 BIC® Clic Stic)  
Medium  
(for 50 BIC® Media Clic or similar)  
Large  
(only for 100 BIC® Ecolutions® Evolution)



	Price (€)
Small	0,77
Medium	1,08
Large	1,49

**PLASTIC BAG**

Small  
(for 25 BIC® Media Clic or similar)  
Medium  
(for 50 BIC® Media Clic or similar)  
Large  
(for 100 BIC® Media Clic or similar)

Price (€)

Small	0,52
Medium	1,03
Large	1,53



**TRAY OF 10 WRITING INSTRUMENTS**



Price (€)
1,73

**COUNT BOX 10U CASES**



Price (€)

0,90

**Available for BIC® Styl'it Luxury Lighter Case family and BIC® Aluminium Flat Case.**  
Disponible pour la famille des BIC® Styl'it Luxury Lighter Case et des BIC® Aluminium Flat Case. Disponible para la familia BIC® Styl'it Luxury Lighter Case y BIC® Aluminium Flat Case. Verfügbar für BIC® Styl'it Luxury Lighter Case family und BIC® Aluminium Flat Case. Disponibile per la famiglia BIC® Styl'it Luxury Lighter Case family e BIC® Aluminium Flat Case.

**COUNT BOX 10U CASES CHILD RESISTANT**



Price (€)

0,90

**Available for BIC® J26, BIC® J38 and BIC® J39 Lighter.**  
Disponible pour les briquets BIC® J26, BIC® J38 et BIC® J39. Disponible para los encendedores BIC® J26, BIC® J38 y BIC® J39 Lighter. Verfügbar für BIC® J26, BIC® J38 und BIC® J39 Lighter. Disponibile per gli accendini BIC® J26, BIC® J38 e BIC® J39.

**COUNT BOX 10U J25 CHILD RESISTANT**



Price (€)

0,70

**Available for BIC® J25 lighter.**  
Disponible pour le briquet BIC® J25. Disponible para el encendedor BIC® J25. Verfügbar für BIC® J25 lighter. Disponibile per accendino BIC® J25.

**BOX OF 50 METAL STYL'IT CASE**



Price (€)

4,07

**Available for BIC® Clip Case, BIC® Styl'it Fashion Case and BIC® 3D Case.**  
Disponible pour les coques BIC® Clip Case, BIC® Styl'it, Fashion Case et BIC® 3D Case. Disponible para BIC® Clip Case, BIC® Styl'it Fashion Case y BIC® 3D Case. Verfügbar für BIC® Clip Case, BIC® Styl'it Fashion Case und BIC® 3D Case. Disponibile per BIC® Clip Case, BIC® Styl'it Fashion Case e BIC® 3D Case.

**BIC** OUTER BOXES

Special design for all the outer boxes related with all the writing instruments.  
Design spéciale pour toutes les boîtes extérieures liées à tous les instruments d'écriture.  
Diseño especial para todas las cajas exteriores de todos los instrumentos de escritura.  
Spezielles Design für alle Außenverpackungen von Schreibgeräten.  
Cartone esterno con design speciale per tutti gli strumenti di scrittura.





# General information

311 — 325

- 312** Make it simple
- 314** 48-hour printing service
- 316** Sticky Notes
- 318** Symbols & Abbreviations
- 320** General Information
- 322** Technical parameters for  
each type of printing
- 324** Product Index
- 325** Colour Table

# MAKE IT SIMPLE!

## SAVE TIME WHEN CALCULATING YOUR FINAL PRICE

LOOK AT THE QUANTITY COLUMN FOR THE PRICE AND THAT'S IT!

### NO SET UP OR SCREEN CHARGES

Except specific Custom Made Trim. See below.

### PERSONALISATION INCLUDED

Price includes personalisation in one position.

### CUSTOM MADE COLOURS FOR TRIM

- An "unlimited" choice of barrel and trim colours for orders over 10.000 units.
- A completely personalised pen in any colour you want.
- Available on an extensive range of products.
- A value added service with only a short additional lead time.
- Available for barrel and trims of: BIC® Round Stic®, BIC® Media Clic, BIC® Media Clic Grip\*, BIC® Clic Stic, BIC® Super Clip, BIC® Wide Body™\*\*, BIC® XS Finestyle

\*For personalised barrel and grip MOQ is 20.000 units

\*\* For personalised section MOQ is 25.000 units

- Set up charge per trim \_\_\_\_\_ 790,00 €
- Set up charge per trim (repeat orders) \_\_\_\_\_ 445,00 €
- Set up charge trim from 100.000 units \_\_\_\_\_ Free of charge

### OTHER CHARGES

Pre-production order (transport not included) \_\_\_\_\_ 129,00 €/order\*

- Available for BIC® Writing Instruments (10 units), BIC® Lighters (10 units), BIC® Flag Booklet (10 units) or BIC® Bags (1 unit).
- Ink cartridge change when available (handling cost only) \_\_\_\_\_ 0,14 €/unit
- BIC® Sticky Notes: Charge for a specific custom made colour as a 5th colour \_\_\_\_\_ 105,00 €
- Cancellations or changes to orders after artwork approval (Subject to BIC Graphic Europe acceptance).  
Fixed cost per change (extra costs such as tooling, components or finished product to be added) \_\_\_\_\_ 70,00 €
- britePix™ individual personalisation \_\_\_\_\_ 65,00 €/order\*\*

\*Not available for BIC® Sticky Notes and digital lighters with Puffy, Puffy Glitter, Metallic, Glow in the dark, Sandy, Holographic and UV finishes.

\*\*britePix™ individual personalisation allows you to change the texts and images of your artwork, giving you a personalised imprint for each of the products in your order. Both texts and information regarding image changes should be provided in an Excel. Should you also require changes in the positioning of the texts and images there will be an additional charge.

- **Terms and conditions of sale apply, please refer to [www.bicgraphic.eu](http://www.bicgraphic.eu)**

**FR> Commandez en toute simplicité !  
Gagnez du temps en calculant votre prix d'achat. Regardez la colonne  
correspondant à votre quantité pour obtenir le prix et c'est tout!**

**SANS FRAIS TECHNIQUE NI FRAIS D'ÉCRAN**

Sauf les couleurs Pantone spécifiques - voir ci-dessous.

**PERSONNALISATION INCLUSE**

Les prix comprennent la personnalisation sur une position, à l'exception des éléments d'écriture métalliques.

**CUSTOM made couleurs par attributs**

Un choix "illimité" de couleurs de corps et d'attributs à partir de 10.000 pièces.

Un stylo entièrement personnalisé dans les couleurs que vous souhaitez.

Disponible pour une large gamme de produits.

Un service supplémentaire à forte valeur ajoutée avec un délai de production additionnel réduit.

Disponible pour les corps et attributs de: BIC® Round Stic®, BIC® Media Clic, BIC® Media Clic Grip®, BIC® Clic Stic, BIC® Super Clip, BIC® Wide Body™™™, BIC® XS Finestyle  
\*Pour un corps et grip personnalisés MOQ de 20.000 pièces.

\*\*La quantité minimum de commande pour personnaliser une section est de 25.000 unités.

Frais technique par attribut...790,00€

Frais technique par attribut (renouvellement de commande)...445,00€

Frais technique par attribut à partir de 100.000 unités...Gratuit

**AUTRES CHARGES**

Échantillon de pré-production (Transport non compris)... 129,00 €/commande\*

Disponible pour les instruments d'écriture BIC® (10 unités), les briquets BIC®

(10 unités), les BIC® Flag Booklet (10 unités) ou les sacs BIC® (1 unité).

Changement de cartouche d'encre quand disponible...0,14 €/unité

BIC® Sticky Notes: Frais pour une couleur spécifique faite sur mesure en tant que cinquième couleur...105,00 €

Modification et annulations de commandes après validation de la fiche de marquage (sujet à l'approbation de BIC Graphic Europe): 70€/modification et annulation.

Coût fixe par changement (coûts supplémentaires tels que l'ouillage, les composants ou le produit fini à ajouter)... 70,00 €

britePix™ personnalisation individuelle...65,00 €/commande\*\*

\*Non inclusive pour les BIC® Sticky Notes et les briquets numériques avec finitions Puffy, Puffy Glitter, Metallic, Glow in the dark, Sandy, Holographic eUV.

\*\*britePix™ personnalisation individuelle vous permet de changer les textes et image de votre photomontage, vous offrant un marquage personnalisé surh cacun des produits de votre commande. Toute information ou image devra être fournie sous un fichier Excel. En cas de modification de la position des textes et images (par rapport à la zone standard) un supplément sera facturé.

Les conditions générales de vente s'appliquent, veuillez vous référer à [www.bicgraphic.eu](http://www.bicgraphic.eu)

**ES> ¡Lo hacemos simple!  
Ahórrese tiempo calculando el precio final.  
Basta con buscar la columna de la cantidad que necesita y ¡ya está!**

**SIN GASTOS TÉCNICOS NI DE SERIGRAFÍA**

Excepto colores de componentes personalizados. Ver a continuación.

**PERSONALIZACIÓN DEL PRODUCTO INCLUIDA**

El precio incluye la personalización en una posición excepto en los instrumentos de escritura metálicos.

**COLORES PERSONALIZADOS PARA COMPONENTES**

Un gran abanico de colores para el cuerpo y los componentes a partir de 10.000 unidades.

Un bolígrafo totalmente personalizado en el color deseado.

Disponible en una amplia gama de best sellers.

Un servicio de valor añadido en un tiempo de entrega adicional muy reducido.

Disponible para cuerpo y componentes de: BIC® Round Stic®, BIC® Media Clic, BIC® Media Clic Grip®, BIC® Clic Stic, BIC® Super Clip, BIC® Wide Body™™™, BIC® XS Finestyle  
\*Personalizar cuerpo y grip tiene una MOQ de 20.000 unidades.

\*\*La cantidad mínima para personalizar de la sección es 25.000 unidades.

Costes fijos de impresión por componente...790,00€

Costes fijos de impresión por componente (pedidos de repetición)...445,00€

Costes fijos de impresión para 100.000 unidades...Sin cargo

**OTROS CARGOS**

Muestras pre-producción (Transporte no incluido)... 129,00 €/pedido\*

Disponible para BIC® Writing Instruments (10 unidades), BIC® Lighters (10

unidades), BIC® Flag Booklet (10 unidades) o BIC® Bags (1 unidad).

Cambio del cartucho de tinta si está disponible...0,14 €/unidad

BIC® Sticky Notes: Cargo para un 5º color hecho a medida...105,00 €

Cancelaciones o cambios en los pedidos después de la aprobación del arte final (sujeto a la aceptación de BIC Graphic Europe).

Modificaciones de pedidos después de aprobación del arte final (sujeto a la aceptación por parte de BIC Graphic Europe) por cambio... 70,00 €

britePix™ personalización individual...65,00 €/pedido\*\*

\*No disponible para BIC® Sticky Notes y digital lighters con acabados Puffy, Puff y Glitter, Metallic, Glow in the dark, Sandy, Holographic y UV.

\*\*La personalización individual britePix™ le permite cambiar los textos e imágenes de su dibujo, ofreciéndole una impresión personalizada para cada uno de los productos de su pedido. Tanto los textos como la información de cambios de las imágenes se deberían facilitar en una hoja Excel. Si se requieren también cambios en la posición de los textos e imágenes, se aplicará un cargo adicional.

Aplicación de los términos y condiciones de venta, por favor consulta [www.bicgraphic.eu](http://www.bicgraphic.eu)

**DE> Einfach und übersichtlich!  
Sparen Sie Zeit beim Berechnen Ihrer Preise.  
Nehmen Sie einfach die entsprechenden Staffelpreise - das war's!**

**KEINE EINRICHTUNGS- ODER SIEBKOSTEN**

Ausgenommen davon sind die Sondereinfärbungen, siehe unten.

**PERSONALISIERUNG INBEGRIFFEN**

Preis inklusive Personalisierung an einer Position außer bei Metall-Schreibgeräten.

**SONDEREINFÄRBUNGEN FÜR AUSSTATTUNGSELEMENTE**

Unbegrenzte Farbauswahl bei Schaft und Ausstattungselementen bei einer Mindestbestellmenge ab 10.000 Stück.

Ein vollständig personalisierter Kugelschreiber in Ihrer Wunschfarbe.

Verfügbar für ein umfassendes Sortiment an Bestsellern.

Eine hervorragende Serviceleistung bei nur geringfügig längeren Lieferzeiten.

Verfügbar für Schäfte und Zierleisten von: BIC® Round Stic®, BIC® Media Clic, BIC® Media Clic Grip®, BIC® Clic Stic, BIC® Super Clip, BIC® Wide Body™™™, BIC® XS Finestyle

\*Für personalisierten Schaft und Griffzone liegt die Mindestbestellmenge bei 20.000 Stück.

\*\*Für personalisierte Spitze liegt die Mindestbestellmenge bei 25.000 Stück.

Einrichtungskosten pro Element...790,00€

Einrichtungskosten pro Element (Folgeauftrag)...445,00€

Einrichtungskosten pro Element ab 100.000 Stück...Kostenfrei

**SONSTIGE KOSTEN**

Freigabemuster (ohne Transport)... 129,00 €/Auftrag\*

Verfügbar für BIC® Schreibgeräte (10 Stück), BIC® Feuerzeuge (10 Stück), BIC® Flag

Booklet (10 Stück) oder BIC® Taschen (1 Stück).

Minenwechsel, wenn möglich. Pro Mine...0,14 €/Stück

BIC® Sticky Notes: Kosten für eine kundenspezifische Farbe als 5. aFrbe...105,00 €

Änderungen nach Erteilung der Druckfreigabe (bedürfen der Zustimmung durch BIC Graphic Europe).

Kosten pro Änderung (zusätzliche Kosten wie Werkzeuge, Komponenten oder fertige

Produkte werden hinzugefügt)... 70,00 €

britePix™ individuelle Personalisierung...65,00 €/Auftrag\*\*

\*Nicht verfügbar für BIC® Sticky Notes und digitale Feuerzeuge mit Puffy-, Puffy Glitter-, Metallic-, Glow-in-the-dark-, Sandy-, Holographic- und UV-Oberflächen.

\*\*britePix™ individuelle Personalisierung bietet Ihnen die Möglichkeit, Texte und Abbildungen Ihres Layouts auszutauschen und somit einen individuell personalisierten

Druck für jeden einzelnen Artikel Ihres Auftrags zu erhalten. Sie übermitteln uns Text,

Logo und alle weiteren Daten in einer Excel-Datei. Falls zusätzlich

Positionsänderungen bei Text oder Abbildungen erforderlich sind, fallen

Zusatzkosten an.

Es gelten die allgemeinen Verkaufsbedingungen, siehe [www.bicgraphic.eu](http://www.bicgraphic.eu)

**IT> Facilissimo!  
Risparmia tempo quando calcoli il prezzo finale.  
Guarda la colonna quantità e hai già il tuo prezzo!**

**NESSUN COSTO IMPIANTO**

Ad eccezione di prodotti con fusto di colore speciale, vedi sotto.

**PERSONALIZZAZIONE INCLUSA**

Il prezzo comprende la personalizzazione in una posizione eccetto sugli

strumenti di scrittura in metallo.

**COLORI CUSTOM MADE PER I PARTICOLARI**

Una illimitata scelta di colori per il corpo e i particolari delle tue penne per ordini a partire da 10.000 pezzi.

Una penna completamente personalizzata con qualsiasi colore desiderate.

Disponibile su un'ampia gamma di best seller.

Un servizio di grande valore con un solo piccolo aumento dei tempi di spedizione.

Disponibile per fusto e decori di: BIC® Round Stic®, BIC® Media Clic, BIC® Media

Media Clic Grip®, BIC® Clic Stic, BIC® Super Clip, BIC® Wide Body™™™, BIC® XS Finestyle

\*MOQ per corpo e grip personalizzati: 20.000 pezzi

\*\*Per la sezione personalizzata l'MOQ è 25.000 unità

Costo di impianto per ordine...790,00€

Costo di impianto per ordine (riassortimenti)...445,00€

Costo di impianto per ordine oltre le 100.000 unità...Gratuito

**COSTI AGGIUNTIVI**

Campione pre-produzione (Trasporto escluso)... 129,00 €/per ordine\*

Disponibile per strumenti di scrittura BIC® (10 unità), accendini BIC® (10 unità),

BIC® Flag Booklet (10 unità) o borse BIC® (1 unità).

Costo cambio colore refill dove possibile. Costo unitario...0,14 €/per unità

BIC® STICKY NOTES: Costo di uno specifico colore personalizzato come quinto

colore...105,00 €

Cancelazione e/o modifiche dopo approvazione della bozza e delal conferma, (saranno soggetti all'accettazione di BIC Graphic Europe).

Cambio dell'ordine dopo l'approvazione della bozza grafica, costo unitario per cambio... 70,00 €

Personalizzazione individuale britePix™...65,00 €/per ordine\*\*

\*Non disponibile per i BIC® Sticky Notes e gli accendini digitali con finiture in rilievo, Puffy Glitter, Glow in the dark, Sandy, Metallic, Holographic e UV.

\*\*La personalizzazione individuale in britePix™ consente di modificare i testi e le immagini della vostra bozza dando un'impronta personalizzata per ciascuno dei prodotti nel vostro ordine. Entrambi i testi e le informazioni relative alle modifiche di immagini dovrebbero essere forniti in un file Excel. Se avete bisogno anche di cambiamenti nel posizionamento dei testi e delle immagini, è previsto un costo aggiuntivo.

Per termini e condizioni di vendita consultare gentilmente: [www.bicgraphic.eu](http://www.bicgraphic.eu)

# 48-HOUR PRINTING SERVICE



## FREE ON MORE THAN 100 BIC® PRODUCTS!

### PROGRAMME REQUIREMENTS



#### WRITING INSTRUMENTS

- 1-colour imprint (For metal products only)  
Laser engraving available)



#### LIGHTERS

- 1-colour imprint



#### IMPRINT POSITION

- 1 standard position



### MAXIMUM QUANTITY

- Price End Column Quantity.

### FOR ONLINE ORDERS

- The promotional code 90000480 must be included in the key word.

### ELIGIBLE COUNTRIES

- EU countries, Switzerland and Norway.

### ADDITIONAL PROGRAMME DETAILS

- In the event that we are out of stock of the item ordered, an alternative item of equal or greater value will be offered. In this case the production lead time will be counted from when the customer has accepted the alternative item and also the new artwork approval.

### ORDER REQUIREMENTS

- Artwork approval must be received by BIC Graphic Europe by 12:00 p.m. GMT+1, Monday to Friday.
- Weekends and local Spanish holidays are not considered as working days.

### SHIPPING

- BIC Graphic Europe cannot guarantee a specific delivery date; only shipping dates are guaranteed.

### OTHER

- Artwork Changes - Please allow additional time for artwork adjustments.
- Accounts on credit hold are not eligible.
- This promotion does not apply to orders delayed by forces or major events beyond BIC Graphic Europe's control.

**FR> Service d'impression en 48 heures**  
**Gratuit sur plus de 100 produits BIC!**  
**Conditions préalables du programme**

**INSTRUMENTS D'ÉCRITURE**

- Impression à 1 couleur (pour les produits métalliques, seule la gravure au laser est disponible)

**BRIQUETS**

- Impression à 1 couleur

**POSITION DE L'IMPRESSION**

- 1 position standard

**Quantité maximale**

- Quantité indiquée en bas de la colonne de la liste de prix.

**Pour les commandes en ligne**

- Le code promotionnel 900000480 doit être inclus dans le mot-clé.

**Pays admis**

- Pays de l'UE, Suisse et Norvège.

**Détails supplémentaires du programme**

- Dans le cas où l'article commandé n'est plus disponible en stock, nous vous offrirons un article alternatif d'une valeur égale ou supérieure. Dans ce cas, le délai de fabrication sera calculé à partir du moment où le client accepte l'article alternatif et approuve le nouveau design.

**Conditions de la commande**

- L'approbation du design doit être reçue par BIC Graphic Europe avant 12:00 GMT+1, du lundi au vendredi.

- Les fins de semaine et les jours fériés locaux d'Espagne ne sont pas considérés comme des jours ouvrables.

**Expédition**

- BIC Graphic Europe ne peut garantir une date spécifique de livraison, seule la date d'expédition est garantie.

**Divers**

- Modifications du design - Veuillez prévoir un temps supplémentaire pour les ajustements de design.
- Les comptes dont le crédit est gelé ne sont pas acceptés.
- Cette promotion n'est pas applicable aux commandes retardées par de mauvaises conditions atmosphériques, des catastrophes naturelles ou d'autres événements hors du contrôle raisonnable de BIC Graphic Europe.

**ES> Servicio de impresión en 48 horas**  
**¡Gratis en más de 100 productos BIC!**  
**Requisitos del programa**

**INSTRUMENTOS DE ESCRITURA**

- Impresión a 1 color (para productos metálicos sólo impresión láser)

**ENCENDEDORES**

- Impresión a 1 color

**POSICIÓN A IMPRIMIR**

- 1 posición estándar

**Cantidad máxima**

- Precio de última columna,

**Para pedidos online:**

- El código promocional 90000480 debe incluirse en la palabra clave.

**Países de aplicación**

- UE, Suiza y Noruega.

**Detalles adicionales del programa**

- En caso de no tener stock de los artículos solicitados, le ofreceremos un artículo alternativo de igual o superior valor. En este caso, el tiempo de espera de producción se contará desde el momento en que el cliente acepte el producto alternativo y la nueva aprobación del diseño.

**Requisitos del pedido**

- Las aprobaciones de diseños deben ser recibidas por BIC Graphic Europe antes de las 12:00 p.m. GMT+1, de lunes a viernes.

- Fines de semana y festivos locales en España no se consideran días hábiles. Envío

- BIC Graphic Europe no puede garantizar una fecha de entrega específica, únicamente se puede garantizar nuestra fecha del envío.

**Otros**

- Cambios en diseños - Las correcciones de sus diseños supondrán tiempo adicional.

- No aplicable en clientes con cuentas pendientes de pago.

- Promoción no aplicable en caso de fuerza mayor o cualquier otra situación fuera del control de BIC Graphic Europe.

**DE> 48-Stunden-Druckservice**  
**Kostenlos für über 100 BIC -Produkte!**  
**Angebotsanforderungen**

**SCHREIBGERÄTE**

- Einfarbiger Aufdruck (bei Metallprodukten ist nur die Lasergravur möglich)

**FEUERZEUGE**

- Einfarbiger Aufdruck

**AUFDRUCKPOSITION**

- Eine Standardposition

**Größtmögliche Menge**

- Menge der letzten Spalte der Preisliste.

**Für Online-Bestellungen**

- Der Werbecode 90000480 muss als Schlüsselbegriff mit angegeben werden. Teilnahmeberechtigter Länder

- Länder der EU, die Schweiz und Norwegen.

**Zusätzliche Angebotsdetails**

- Falls wir den Artikel Ihrer Bestellung nicht auf Lager haben, werden wir Ihnen einen alternativen Artikel mit dem gleichen oder einem höheren Wert anbieten. In diesem Fall wird die Produktionszeit von dem Moment an gezählt, ab dem der Kunde den alternativen Artikel und die neue Vorlagefreigabe akzeptiert hat. Bestellanforderungen

- Die Freigabe der Vorlage muss bei BIC Graphic Europe um 12:00 P.M. GMT+1, von Montag bis Freitag eingehen.

- Wochenenden und lokale spanische Feiertage werden nicht als Werktag anerkannt.

**Versand**

- BIC Graphic Europe kann kein spezifisches Lieferdatum garantieren, sondern nur das voraussichtliche Versanddatum bekanntgeben.

**Sonstiges**

- Änderungen der Vorlage - Bitte geben Sie uns etwas zusätzliche Zeit für Anpassungen an der Vorlage.

- Kreditkonten sind nicht zulässig.

- Diese Aktion gilt nicht für Bestellungen mit Verzögerungen aufgrund von schwierigen Wettersituationen, Naturkatastrophen oder jedweder anderer

- Umstände, die sich außerhalb des Einflussbereiches von BIC Graphic Europe bewegen.

**IT> Servizio di stampa 48 ore**  
**Gratis su più di 100 prodotti BIC!**  
**Condizioni del programma**

**STRUMENTI DI SCRITTURA**

- Stampa a 1 colore (per i prodotti in metallo disponibile solo incisione laser)

**ACCENDINI**

- Stampa a 1 colore

**POSIZIONE DI STAMPA**

- 1 posizione standard

**Quantitativo massimo**

- Quantitativo ultima colonna del listino prezzi.

**Per ordini online**

- Il codice promozionale 90000480 deve essere incluso nella parola chiave. Paesi che possono accedere all'offerta

- Paesi UE, Svizzera e Norvegia.

**Ulteriori dettagli**

- In caso di esaurimento dell'articolo ordinato, ti offriremo un articolo. Alternativo di valore equivalente o superiore. In questo caso il tempo di produzione sarà calcolato dal momento in cui il cliente ha accettato l'articolo alternativo e approvato la nuova grafica.

**Requisiti dell'ordine**

- L'approvazione della grafica deve essere ricevuta da BIC Graphic Europe entro le ore 12:00 p.m. GMT+1, da lunedì a venerdì.

- Fine settimana e festività locali spagnole non sono considerati giorni lavorativi.

**Spedizione**

- BIC Graphic Europe non può garantire una data specifica di consegna, solo la data di spedizione.

**Altro**

- Modifiche della grafica - si prega di concedere tempi più lunghi per gli adeguamenti della grafica.

- Non applicabile a clienti con sospensione del credito.

- Questa promozione non si applica a ordini ritardati da condizioni meteorologiche avverse, disastri naturali o altri eventi al di fuori del ragionevole controllo di BIC Graphic Europe.

# STICKY NOTES GENERAL INFORMATION



Due to the nature of BIC® Sticky Notes paper, resulting imprints will appear as matte, without shine. The reference colours chosen must be selected from the exact colour guide. **BIC® Sticky Notes are printed using a 4-colour process (CMYK), a technique which adjusts the imprint colour to match the references in the exact colour guide.** As such, the resulting imprint may differ slightly from the selected exact colour guide.

If a direct exact colour is desired a fifth colour may be chosen from the aforementioned Guide for an additional charge. For more information on achieving the closest colour match for imprints on different products within our catalogue please contact our Customer Service Department.



## IMPRINTING AREA

**Despite the fact that it's possible to print on the upper part of the pad (the adhesive area)** we can only print up to 60% colour in this area. Apart from the adhesive area, we recommend only printing 30% of the print area of the product to leave space for note taking and avoid poor ink absorption.

## DIE CUT SPECIAL SHAPES AND OTHER CUSTOMISATIONS

**Be the most original!** Request your BIC® Sticky Notes Adhesive pad with your desired custom-made shape or customise with your own logo the backsheet of the pads. Please check the conditions of these special customisations with your usual contact person.

## SHADOW

**Shadows or phantom imprints are available at no extra charge.** Photographs, line drawings and large logos that cover most of the space at the centre look best. As they are very light, text and phone numbers are not recommended as phantoms. The most appealing shades are about 10%.

## FR> Informations BIC® Sticky Notes

En raison de la nature du papier BIC® Sticky Notes, les résultats à l'impression auront un aspect mat, et non brillant. Les couleurs de référence choisies doivent être sélectionnées dans le guide d'une couleur spécifique. Les BIC® Sticky Notes sont imprimés en quadrichromie (CMYK), une technique qui ajuste la couleur d'impression afin de correspondre aux références d'une couleur spécifique.

Pour toute demande d'une couleur spécifique, nous pouvons proposer une impression avec une 5e couleur de ce Guide, à un prix majoré. Pour plus d'informations sur la manière d'obtenir la couleur correspondante la plus proche pour des impressions sur différents produits de notre catalogue, veuillez contacter notre service client.

### ZONE D'IMPRESSION

Même si la partie supérieure du bloc de papier peut être imprimée (la partie adhésive), elle peut seulement être imprimée jusqu'à 60 % d'encre totale.

Indépendamment de la zone adhésive, nous recommandons d'imprimer uniquement 30 % de la surface du produit afin de laisser de l'espace pour la prise de notes et d'éviter ainsi d'éventuelles problèmes d'adhésion de l'encre sur le papier.

### FORMES SPÉCIALES D'ESTAMPAGE ET AUTRES PERSONNALISATIONS

Soyez le plus original ! Demandez vos blocs adhésifs BIC® Sticky Notes avec votre forme personnalisée ou adaptez-les en incluant votre propre logo sur le verso des blocs. Veuillez vérifier les conditions de ces formules spéciales avec votre contact habituel.

### IMPRESSION SHADOW OU FANTÔME

Les impressions Shadow ou fantôme sont disponibles sans surcoût. Les photographies, les dessins ou logos de grande taille qui couvrent la majorité de la surface centrale ont un meilleur rendu. Comme ces impressions sont très claires, les textes et numéros de téléphone ne sont pas recommandés en Shadow ou fantôme. Les meilleurs rendus sont obtenus à partir d'images tramées aux environs de 10 %.

## ES> Información BIC® Sticky Notes

Debido a la naturaleza del papel para BIC® Sticky Notes el resultado impreso será mate, nunca brillo. Los colores de referencia solicitados deben ser de la guía de colores exactos. El proceso de impresión para BIC® Sticky Notes es en cuatricromía (CMYK), y el resultado impreso puede variar de la referencia pantone solicitada.

En el caso de querer un color directo, podemos ofrecer la impresión con un 5º color de dicha Guía. Para una mejor aproximación de color entre los diferentes productos de nuestro catálogo, póngate en contacto con nuestro departamento de Atención al Cliente.

### ÁREA DE IMPRESIÓN

A pesar de que la parte superior del taco de papel se puede imprimir (la parte adhesiva), sólo se puede imprimir hasta un 60% de tinta total. Además de la zona adhesiva, recomendamos imprimir únicamente el 30% de la zona correspondiente al taco de papel, con el fin de dejar más espacio libre para tomar notas y evitar una absorción incorrecta de la tinta.

### FORMAS ESPECIALES Y OTRAS PERSONALIZACIONES

¡Es el más original! Solicita tus BIC® Sticky Notes con la forma deseada o personaliza con tu propio logo la hoja trasera de los blocs adhesivos. Por favor, consulta las condiciones de estas personalizaciones especiales con tu persona de contacto habitual

### IMPRESIÓN "MARCA DE AGUA"

Podemos ofrecerte "marcas de agua" sin coste adicional alguno. Las fotografías, los dibujos lineales o los logotipos de gran tamaño que cubren la mayor parte del espacio central son las opciones que ofrecen mejores resultados. Puesto que la impresión de "marcas de agua" es muy clara, no se recomienda para números de teléfono o texto. Las mejores "marcas de agua" son aquellas que se imprimen en torno al 10% de intensidad.

## DE> Information BIC® Sticky Notes

Aufgrund der Papier- Beschaffenheit der BIC® Sticky Notes, fällt das Druckergebnis matt aus. Die gewünschten Farbreferenzen wählen Sie aus der PMS Farbpalette aus. BIC® Sticky Notes werden im Offset-Druck nach Euroskala (CMYK) bedruckt. Dank dieser Technik wird das Farbergebnis an die gewünschten Pantone-Referenzen angenähert. Wenn Sie ausdrücklich eine Pantone-Farbe wünschen, können Sie zusätzlich eine fünfte Farbe aus unserem verfügbaren Repertoire auswählen.

Hierfür wird ein Aufpreis berechnet. Weitere Informationen zur Farbangleichung bei Bestellung verschiedener Produkte erhalten Sie von Ihrem Customer Service.

### DRUCKBEREICH

Obwohl es möglich ist auf dem oberen, dem Haftbereich des BIC® Sticky Notes zu drucken kann nur bis zu maximal 60% der Druckfarbe aufgebracht werden. Außerhalb des Haftbereichs sollte maximal 30% der Fläche bedruckt werden, um möglichst viel Platz für Notizen frei zu lassen und das Risiko unvollständiger Aufnahme der Schreibtinte zu vermeiden.

### SPEZIELL GESTANZTE FORMEN UND ANDERE KUNDENSPEZIFISCHE ANPASSUNGEN

Seien Sie der Originellste! Bestellen Sie Ihre BIC® Sticky Notes Haftnotizen in der von Ihnen gewünschten Form oder individualisieren Sie die Rückseite der Pads mit Ihrem eigenen Logo. Bitte sprechen Sie über die Möglichkeiten für diese speziellen kundenspezifischen Anpassungen mit Ihrem zuständigen Ansprechpartner.

### SHADOW-DRUCK

Flood- und Shadowdruckeffekte sind ohne Aufpreis erhältlich. Fotos, Zeichnungen oder große Logos, die einen Großteil der Grundfläche bedecken, eignen sich dafür am besten. Texte und Telefonnummern sind für Hintergrunddrucke nicht geeignet, da sie zu schwierig zu erkennen sind. Beste Resultate werden mit 10% Rasterung erzielt.

## IT> Informazioni BIC® Sticky Notes

Data la natura della carta usata per BIC® Sticky Notes il risultato di stampa sarà opaco, mai brillante. I colori scelti per la stampa devono essere colori di riferimento esatti. Il processo di stampa di BIC® Sticky Notes è la quadricromia (CMYK) ed il risultato può variare rispetto al colore di riferimento richiesto.

Se si desidera un colore preciso, potrebbe essere scelto un quinto colore dalla suddetta guida a un costo aggiuntivo. Per maggiori informazioni sulla migliore corrispondenza del colore di stampa per i vari prodotti del nostro catalogo, contattare il nostro Servizio Clienti.

### AREA DI STAMPA

Anche se la parte superiore del blocchetto si può stampare (la parte adesiva) si raccomanda di non usare quest'area per una stampa a tutto colore.

A parte la zona adesiva, si raccomanda di stampare unicamente il 30% della superficie del prodotto, per lasciare più spazio bliero per prendere appunti ed evitare un assorbimento irregolare dell'inchiostro.

### FORME SPECIALI FUSTELLATE E ALTRE PERSONALIZZAZIONI

Sii il più originale! Richiedi il tuo blocco note adesivo BIC® Sticky Notes con la forma realizzata su misura per te, oppure personalizza con il tuo logo il lato posteriore del blocco note. Ti invitiamo a verificare le condizioni di queste speciali personalizzazioni con il tuo referente abituale.

### EFFETTO FANTASMA

Possiamo stampare effetti fantasma o sfumature senza costi aggiuntivi. Le fotografie, i disegni lineari o i logotipi di grandi dimensioni che coprono la maggior parte dello spazio centrale sono le opzioni che danno i migliori risultati. Dal momento che le stampe ad effetto fantasma sono molto chiare, non sono consigliabili per numeri di telefono o testo.

Gli effetti fantasma migliori sono quelli che si stampano a circa il 10%.



# SYMBOLS & ABBREVIATIONS

## PRINTING TECHNIQUES

-  **Puffy glitter**  
Coloured glitter texture.
-  **Puffy Printing**  
Highlighted personalisation giving a relief effect to your logo.
-  **4-Colour Process**  
Allows reproduction of high-resolution images. Ideal for reproducing photos.
-  **BR**  
Brilliant finish.
-  **Glow in the dark**  
Make your brand glow even in the dark.
-  **Metallic Finish**  
Create metallic effects on images and backgrounds.
-  **Holographic Finish**  
Convert your logo into a three-dimensional
-  **Matt**  
Matt finish.
-  **UV**  
High gloss finish.
-  **Sandy**  
Sandpaper effect with a granulated texture.

-  **Digital**  
High-definition 4-colour process. 360° degrees and full length of the barrel/body.
-  **britePix™**  
Full-colour with photographic excellence, producing a durable imprint that ensures lasting impressions of your logo.
-  **britePix™ Texture**  
britePix™ Texture is a fresh addition to our britePix™ concept: now you don't just see the full colour – you can feel it!
-  **britePix™ personalisation**  
Personalise each unit within the same britePix™ order.

## ABBREVIATIONS











- SP** = Screen printing
- LE** = Laser engraving
- HS** = Hot stamping
- DB** = Debossing
- PD** = Pad printing
- DG** = Digital
- BP** = britePix™
- BP Texture** = britePix™ Texture
- OT** = Offset transfer
- MOQ** = Minimum order quantity
- 3D** = 3D Embossing
- SU** = Sublimation

## INK COLOURS

-  Black
-  Yellow
-  Fluo
-  Blue Pastel
-  Yellow Pastel
-  Coral Pink
-  Light Blue
-  Light Green
-  Pink
-  Dark Blue
-  Green Pastel
-  Purple Pastel
-  Red
-  Apple Green
-  Purple
-  Orange
-  Dark Green

 **BIC® Easy-Glide system option**  
Offers 35% smoother and bolder write-out than our standard ink.

## WRITING MODES

-  **M** Medium  
**F** Fine  
**B** Bold
-  **SP Stylus Pen**
-  **MP Mechanical Pencil**  
Ø 0,7 mm
-  **FS Finestyle**
-  **PC Pencil**
-  **HL Highlighter**
-  **R Roller Ball**
-  **T Tipp-Ex®**  
6 m
-  **MK Marker**
-  **G Gel**

## OTHER SYMBOLS

 **Mix&Match**  
Hundreds of colours of components in stock of writing instruments for full personalisation.

 **Exact colour match**  
Choose the exact colour for trims that best matches your logo.

 **QR code**  
Scan QR code and watch the video.

 **48-Hour**  
48-Hour Printing Service

 **Möbius Loop**  
Product contains recycled material. If you want more information about our BIC® Ecolutions® & how it's made visit: [bicgraphic.eu/ie/sustainable-development.html](http://bicgraphic.eu/ie/sustainable-development.html)

 **FSC**  
Certification to promote the appropriate environmental management

 **Country of Origin**

 **APP**  
Download the BIC Graphic App and scan the pages that have this icon.

 **New / New colours**

 **EN 13869**  
European Child Resistant Regulation for lighters.

 **ISO 22702**  
This standard certifies the quality of all utility lighters.

 **ISO 9994**  
International Safety Standards for lighters.

 **Sticky Notes**  
Number of sheets.

 **Notebooks**  
Number of sheets.

 **Packaging Information**  
500 : 15 kg

 **BIC® Boy**  
Iconic BIC® Boy is embossed here

 **Lubricating strip**

 **Number of blades**

 **BIC® Mega Lighter**  
Usage of BIC® Mega Lighter in everyday occasion.

 **Number of flames**

 **Shaving gel tube 10ml** only available for Austria, Belgium, France, Germany, Italy, Luxembourg, The Netherlands, Portugal, Romania, Spain, Switzerland and UK.

 **Exclusive**  
Exclusive items only available through our catalogue.

 **Bluetooth®**

 **Battery autonomy**

 **Wireless**

 **Power entrance/exit**

 **Dot per Inch**

**DIMENSIONS** Dimensions published of each product correspond to its maximum size, regardless of the drawing position.



## FR> Options spéciales

Options spéciales

- Puffy glitter: texture avec paillettes colorées
- Puffy printing: Une personnalisation soulignée par notre encre « Puffy », pour donner un effet de relief à votre logo.
- 4-colour process: Permet la reproduction d'images de haute résolution. Idéal pour la reproduction de photographies. Original et attrayant.
- Encre métallique: Modernisez votre message en ajoutant des encres métalliques d'impression, sans frais. Disponible en bleu, vert et rose.
- BR: Finition brillante.
- Glow in the dark: faites étinceller votre marque même dans le noir.
- Finition métallique: "Crée des effets métalliques sur les images ou l'arrière-plan."
- Finition holographique: Transformez votre logo en 3D.
- Mate: Finition mate.
- UV: Finition extra brillante.
- Sandy: effet papier de verre, avec une texture granuleuse
- Digital: Quadrichromie haute définition, à 360° degrés et sur toute la longueur du corps du crayon.
- britePix™: Votre message peut maintenant être imprimé en quadrichromie et d'une excellente qualité image afin de produire une impression durable et persistante de votre logo.
- britePix™ Texture: britePix™ Texture apporte une nouvelle touche haut de gamme au concept britePix™. Désormais, vous pouvez non seulement voir tout en couleur, mais aussi le toucher!
- britePix™ personalisation: Personalisation britePix™ Personalisez chaque unité dans une seule et même commande.

Abréviations

SP = Sérigraphie  
LE = Gravure laser  
4CP = Procédé de quadrichromie  
HS = Estampage  
DB = Embossage  
PD = Tamponographie  
DT = Transfert digital  
DG = Digital  
BP = britePix™  
BP Texture = britePix™ Texture  
OT = Transfert offset  
MOQ = Offset transfer minimale de commande  
3D = 3D embossage  
SU = Sublimation

Ink colours  
Encre noire  
Encre bleu clair  
Encre bleu foncée  
Encre rouge  
Encre fluo  
Jaune pastel  
Orange  
Vert pastel  
Jaune  
Modes d'écriture

Encre verte claire  
Encre verte foncée  
Encre rose  
Encre violette  
Bleu Pastel  
Rose corail  
Vert pomme  
Pourpre pastel

- Bille • Crayon
- Stylo Plume / • Stylo à bille roulante
- Surligneur • Gel
- Marqueur • Feutre pointe fine
- Porte-mine • Tipp-Ex®
- BIC® Easy-Glide system option: Offre une encre qui est 35 % plus lisse et plus épaisse que votre stylo à bille actuel.
- Autres symboles
- Mix&Match: Des centaines de couleurs de composants en stock pour la personnalisation complète des instruments d'écriture
- PMS Service: Choisissez la couleur PMS pour des décorations les mieux adaptées à votre logo
- QR CODE: scannez le QR code et visionnez le vidéo
- 48 hour: Service 48 h disponible
- Mobius loop: Le produit contient des matériaux recyclés. Si vous voulez plus d'informations sur notre BIC® Ecolutions™ et son mode de fabrication <https://www.bicworld.com/fr/nosengagements/>
- en-bref
- FSC Certification pour promouvoir la gestion environnementale appropriée
- Pays d'origine
- APP: Téléchargez l'application de BIC® Graphic et scannez les pages où figure cette icône.
- Nouveautés / Nouveaux colors.
- EN 13869: Règlement de sécurité des enfants pour les briquets
- ISO 22702: Cette norme certifie la qualité de tous les briquets à usages multiples.
- ISO 9994: Normes de sécurité internationales pour les briquets.
- Sticky Notes: Nombre de pages
- Notebooks: Nombre de pages
- Informations sur l'emballage
- BIC® Boy: Iconic BIC® Boy est embossé
- Bande lubrifiante
- Nombre de lames
- BIC® Mega Lighter: usage quotidien du BIC® Mega Lighter
- Nombre d'allumages
- Tube de gel à raser 10 ml uniquement disponible pour l'Autriche, la Belgique, la France, l'Allemagne, l'Italie, le Luxembourg, les Pays-Bas, le Portugal, la Roumanie, l'Espagne, la Suisse et le Royaume-Uni.
- Exclusive Articles exclusifs disponibles seulement dans notre catalogue.
- Bluetooth®
- Autonomie de la batterie
- Sans câbles
- Entrée/sortie alimentation
- Point par pouces

Dimensions  
Les dimensions publiées de tous les produits correspondent à la taille maximale, quelle que soit la position du dessin.

## ES> Símbolos y abreviaturas

Técnicas de impresión

- Puffy glitter: textura de color brillante
- Impresión Puffy: Resalta tu personalización dándole efecto relieve a tu logo.
- 4-colour process: Permite la reproducción de imágenes de alta resolución. Ideal para la reproducción de fotografías. Original y atractivo.
- Tinta metálica: Tinta metálica sin ningún coste adicional. Disponible en colores azul, verde y rosa.
- BR: Acabado brillante
- Glow in the dark: Haz que tu marca brille incluso en la oscuridad.
- Acabado metálico: Crea efectos metálicos en imágenes o fondos.
- Acabado holográfico: Convierte tu logo en una imagen tridimensional usando hologramas.
- Mate: Acabado mate.
- UV: Acabado super brillante.
- Sandy: Textura granulada con efecto arena.
- Digital: Cuatricromía de alta definición. 360° en el cuerpo entero.
- britePix™: Impresión a todo color con resultados fotográficos de alta calidad que asegura una impresión duradera de su logo.
- britePix™ Texture: britePix™ Texture es un añadido premium al concepto britePix™ - ahora no sólo puedes verlo sino que también puedes sentirlo!
- britePix™ personalisation: Personalización britePix™ Personaliza cada unidad en el mismo pedido britePix™.

Abreviaturas

SP = Serigrafía  
LE = Impresión a láser  
4CP = Proceso de cuatricromía  
HS = Hot stamping  
DB = Grabado en relieve  
PD = Tampografía  
DT = Transferencia digital  
DG = Digital  
BP = britePix™  
BP Texture = britePix™ Texture  
OT = Transferencia offset  
MOQ = Cantidad mínima de pedido  
3D = relieve 3D  
SU = Sublimación

Colores de tinta

Tinta negra  
Tinta azul claro  
Tinta azul oscuro  
Tinta roja  
Tinta fluo  
Amarillo pastel  
Naranja  
Verde pastel  
Amarillo

Tinta verde claro  
Tinta verde oscuro  
Tinta rosa  
Tinta morada  
Azul pastel  
Rosa coral  
Verde manzana  
Verde manzana

Modos de escritura

- Bolígrafo • Lápiz
- Pluma • Roller
- Resaltador • Gel
- Marcador • Escritura fina
- Portaminas • Tipp-Ex®
- BIC® Easy-Glide system option: 35% más fluido y más intenso que nuestro bolígrafo actual.
- Otros símbolos
- Mix&Match: Cientos de componentes de instrumentos de escritura para una completa personalización
- PMS Service: Elija para los atributos, el colour PMS que mejor se adapte a su logo
- Código QR: Escanea el código QR y mira el video
- 48 hour: Servicio 48 h disponible
- Mobius loop: El producto contiene material reciclado. Para más información sobre nuestros productos BIC Ecolutions™ y cómo están hechos visita: <https://www.bicworld.com/fr/nos-engagements/en-bref>
- FSC: Certificación para promover la apropiada gestión ecológica
- País de origen
- APP: Descarga la aplicación de BIC® Graphic y escanea las páginas que tengan este icono.
- Nuevo / Nuevos colores
- EN 13869: Regulaciones Europeas para Encendedores con seguridad para niños.
- ISO 22702: This standard certifies the quality of all utility lighters.
- ISO 9994: Normas internacionales de seguridad para encendedores.
- Sticky Notes: Número de hojas.
- Notebooks: Número de hojas.
- Información de envasado
- BIC® Boy: El icónico BIC® Boy con relieve aquí
- Banda lubricante
- Número de hojas
- BIC® Mega Lighter: Usa el BIC® Mega Lighter diariamente.
- Número de encendidos
- Gel de afeitado de 10ml sólo disponible para Austria, Bélgica, Francia, Alemania, Italia, Luxemburgo, Países Bajos, Portugal, Rumania, España, Suiza y Reino Unido.
- Exclusivo Productos exclusivos sólo disponibles a través de nuestro catálogo.
- Bluetooth®
- Autonomía de la batería
- Sin cables
- Entrada/salida corriente eléctrica
- Puntos por pulgada

Dimensiones  
Las dimensiones publicadas en cada producto corresponden a su tamaño máximo, independientemente de la posición que muestre el dibujo.

## DE> Symbole & abkürzungen

Spezielle Möglichkeiten

- Puffy glitter: Farbige Glitter-Texture
- Puffy printing: Eine überzeugende Personalisierung mit unserer "Puffy"-Tinte, die Ihrem Logo einen Relief-Effekt verleiht.
- 4-Farbrück: Aufdruck von Bildern mit hoher Auflösung. Ideal für Fotodrucke. Origineller Blickfang.
- Metallic-Tinte: Verleihen Sie Ihrer Botschaft ohne Aufpreis eine besondere Wertigkeit mit Metallic-Drucktinten. Verfügbar in Blau-, Grün- und Rosatönen.
- BR: Digitaldruck mit Glanzeffekt.
- Glow in the dark: Lassen Sie Ihre Marke erstrahlen, selbst in der Dunkelheit.
- Metallic-Ausführung: Drucktinten mit Metallic-Effekt ohne Aufpreis. Erhältlich in Blau, Grün und Pink.
- Holographie-Ausfertigung: Verwandeln Sie Ihr Logo in ein dreidimensionales Bild durch Hologramme. Verleiht Ihrer Botschaft eine atemberaubende Wirkung.
- Matte: Digitaldruck mit mattem Finish.
- UV: Digitaldruck mit Hochglanzeffekt.
- Sandy: Sandpapier-Effekt mittels feinkörniger Oberfläche.
- Digital: Hochauflösender Vierfarb-Prozess. 360° Rundumdruck auf dem ganzen Schaft.
- britePix™: Ihre Nachricht kann nun in voller Farbe mit grafischer Brillanz gedruckt werden, wobei ein dauerhafter, lebendiger und bleibender Eindruck Ihres Logos sichergestellt wird.
- britePix™ Texture: britePix™ Texture ist eine neue Ergänzung für unser britePix™ Druckkonzept - man kann die Farben jetzt nicht nur sehen, man kann sie auch fühlen!
- britePix™ Personalisierung: brite Pix™ Personalisierung Personalisieren Sie Ihre brite Pix Bestellung. Geben Sie jedem Artikel Ihrer Bestellung eine individuelle Note.

Abkürzungen

SP = Siebdruck  
LE = Lasergravur  
4CP = 4-Farbrück  
HS = Hotstamping  
DB = Prägung  
PD = Tampondruck  
DT = Digitaldruck  
DG = Digital  
BP = britePix™  
BP Texture = britePix™ Texture  
OT = Offset-Transferdruck  
MOQ = Mindestbestellmenge  
3D = 3D-Prägung  
SU = Sublimationsdruck

Ink colours  
Schwarze Tinte  
Hellgrüne Tinte  
Hellblaue Tinte  
Dunkelgrüne Tinte  
Rosa Tinte  
Fluoreszierende Tinte  
Pastellblau  
Gelb  
Pastellgrün  
Koralle  
Schreibtechniken

Hellgrüne Tinte  
Dunkelgrüne Tinte  
Rosa Tinte  
Violette Tinte  
Orange  
Pastellgelb  
Apfelgrün  
Pastellviolett

- Kugelschreiber • Bleistift
- Füllfederhalter • Rollerball
- Leuchtmarker • Gelschreiber
- Permanent Marker • Fineliner
- Druckbleistift • Tipp-Ex®
- BIC® Easy-Glide system option
- 35% weicher und präziser als eine herkömmliche Mine
- Andere Symbole
- Mix&Match: Hunderte von Farben bei den Schreibgeräte-Komponenten auf Lager. Für eine komplette Personalisierung.
- PMS Service: Wählen Sie die PMS-Farbe für Verzierungen, die am besten zu Ihrem Logo passt
- QR CODE: Scannen Sie den QR Code und sehen Sie sich das Video an.
- 48 hour: 48 Stunden Service
- Möbius Schleife: Das Produkt enthält recyceltes Material. Mehr Informationen unter: [bicgraphic.eu/ie/sustainable-development.html](http://bicgraphic.eu/ie/sustainable-development.html)
- FSC: Zertifikat zur Förderung des angemessenen Umweltmanagements
- Herkunftsland
- APP: Laden Sie sich die BIC Graphic App herunter und scannen Sie die mit diesem Symbol gekennzeichneten Artikel.
- Neue / Neue Farben
- EN 13869 Europäische Kindersicherheitsnorm für Feuerzeuge.
- ISO 22702 Dieser Standard zertifiziert die Qualität aller Feuerzeuge.
- ISO 9994 Internationale Sicherheitsstandards für Feuerzeuge.
- Sticky Notes Anzahl der Blätter.
- Notebooks Anzahl der Blätter.
- Information zu Verpackungen
- BIC® Boy: Der ikonische BIC® Boy ist hier aufgeführt
- Gleihtstreifen
- Anzahl der Klängen
- BIC® Mega Lighter: Verwendung des BIC® Mega Lighters in Alltagssituationen.
- Anzahl der Zündungen
- Rasiergelbte 10 ml nur erhältlich in Österreich, Belgien, Frankreich, Deutschland, Italien, Luxemburg, Niederlande, Portugal, Rumänien, Spanien, Schweiz und Vereinigtem Königreich.
- Exklusivartikler Markiert Artikel, die Sie ausschließlich aus unserem Katalog bestellen können.
- Bluetooth®
- Kabellänge
- Wasserabweisend
- Leistung
- Stoßfest
- Punkte pro Zoll

Abmessungen  
Die Abmessungen, die für jedes Produkt angegeben werden, entsprechen dessen maximaler Größe, in Unabhängigkeit von der Zeichnungsposition.

## IT> Simboli & abbreviazioni

Opzioni speciali

- Puffy glitter: texture con glitter colorati
- Puffy printing: Una personalizzazione evidenziata con il nostro inchiostro "Puffy" per dare un effetto a rilievo al tuo logo.
- 4-colour process: Consente la riproduzione di immagini ad alta risoluzione. Ideale per la riproduzione di fotografie. Originale e attraente.
- Inchiostro metallizzato: Stampa metallizzati senza costi aggiuntivi. Disponibile nei colori blu, verde e rosa.
- BR: finitura brillante
- Glow in the dark: rendi il tuo marchio visibile anche al buio
- Finitura metallica: Crea effetti, immagini o sfondi metallici. Il tuo marchio sarà inconfondibile.
- Finitura olografica: Trasforma il tuo logo in un'immagine tridimensionale con gli ologrammi. Rende il tuo messaggio straordinario.
- Matte: Finitura opaca
- UV: finitura lucida
- Sandy: effetto sabbia con texture granulata
- Digital: Alta definizione - stampa in digitale in quadricromia, 360° gradi su tutta la lunghezza del corpo.
- britePix™: Il messaggio può essere stampato a colori con l'eccellente risoluzione fotografica che assicura un'immagine durevole e vibrante del vostro logo
- britePix™ Texture britePix™ Texture è un salto di qualità nel nostro concetto di stampa britePix™ - ora non solo puoi vedere il colore pieno, ma puoi anche toccarlo!
- britePix™ personalisation Personalizzazione britePix™. Personalizza ogni unità dello stesso ordine britePix™

Abbreziature

SP = Serigrafia  
LE = Incisione laser  
4CP = Stampa in quadricromia  
HS = Stampa a caldo  
DB = Bassorilievo  
PD = Stampa a tampone  
DT = Trasferimento digitale  
DG = Digital  
BP = britePix™  
BP Texture = britePix™ Texture  
OT = transfer in offset  
MOQ = Quantità minima d'ordine  
3D = 3D Rilievo  
SU = Sublimazione

Colori d'inchiostro:

nero verde chiaro  
azzurro verde  
blu rosa  
rosso viola  
fluo Blu Pastello  
Giallo Pastello Rosso Corallo  
Arancio Verde Mela  
Verde Pastello Viola Pastello  
Giallo

Modalità di scrittura

- Penna a sfera • Matita
- Penna Stilografica • Roller
- Evidenziatore • Gel
- Pennarello • Finestyle
- Portamine • Tipp-Ex®
- BIC® Easy-Glide system option
- Offire il 35% di scrittura più fluida e corposa rispetto agli inchiostri standard.
- Altri simboli
- Mix&Match: Centinaia di colori dei componenti di produzione degli strumenti di scrittura per una personalizzazione completa.
- PMS Service: Scegli il colore PMS per le finiture che meglio si adatta al tuo logo
- QR CODE: scannerizza il QR code e guarda il video
- 48 hour: Servizio in 48 ore disponibile
- Mobius loop: Per maggiori informazioni sui nostri prodotti BIC Ecolutions™ e da cosa sono composti visita la web: <https://www.bicworld.com/fr/nos-engagements/en-bref>
- FSC: Certificazione della corretta gestione ambientale
- APP: Scarica la app di Bic Graphic e scannerizza le pagine che abbiano quest'icône.
- Paese d'origine
- Nuovi / Nuovi colori
- Morbido al tatto! Toccare questo prodotto sarà una sorpresa.
- EN 13869: Normativa europea per accendini sulla sicurezza dei bambini
- ISO 22702: Questa normativa certifica la qualità di tutti i nostri accendini.
- ISO 9994: Norme di sicurezza internazionali per gli accendini.
- Sticky Notes: Numero di fogli.
- Notebooks: Numero di fogli.
- Informazioni sul packaging
- BIC® Boy: L'icónico BIC Boy è impresso qui
- Striscia lubrificante
- Numero di lame
- BIC® Mega Lighter: Utilizzo quotidiano del BIC® Mega Lighter
- Numero di accensioni
- Confezione di gel da rasatura da 10 ml, disponibile solo per Austria, Belgio, Francia, Germania, Italia, Lussemburgo, Paesi Bassi, Portogallo, Romania, Spagna, Svizzera e Regno Unito.
- Esclusivo Prodotti che sono esclusivi all'interno del nostro catalogo.
- Bluetooth®
- Autonomia della batteria
- Senza cavo
- Entrata/uscita alimentazione
- Punti per pollice

Dimensioni  
Le dimensioni pubblicate relative a ciascun prodotto corrispondono alla sua dimensione massima indipendentemente dalla posizione del disegno.

# GENERAL INFORMATION

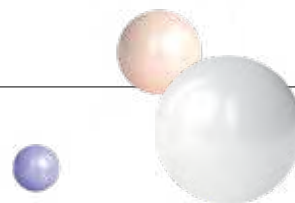

## FILE INFORMATION

Please submit your artwork in one of the following formats:

- Electronic file with the graphic design (artwork).
- Separate file for the text. For individual laser engraving please provide texts only in Excel® format (.xls)

## ARTWORKS FEATURES

Please submit your artwork in one of the following formats:

- JPG / 350 dpi not compressed (only for images, no texts)
- PDF / outlined
- Illustrator® CC / outlined
- Photoshop® CC / with layers
- ZIP files

In order to facilitate a fluid order process and obtain an appropriate final result, it is important to provide us the information in one of the above listed formats. Should the customer's design not fit into our imprint area, we will modify it accordingly.

### Typefaces:

- All the typefaces must be converted to an artwork. Verify the minimum type sizes & line weights. Please, contact Customer Service for further information.

## SPECIAL FOR WRITING PRODUCTS

Available imprint area depends on required printing technique.

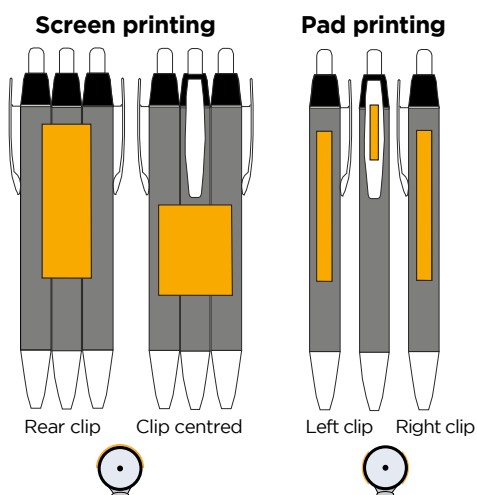

## SPECIAL FOR DIGITAL LIGHTERS (J25, J23 & J26)

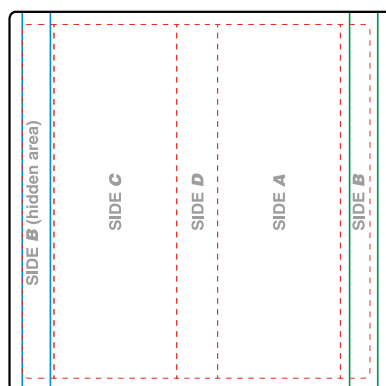

- If a direct exact colour is desired a fifth colour may be chosen from the aforementioned Guide for an additional charge. For more information on achieving the closest colour match for imprints on different products within our catalogue please contact our Customer Service Department

**FR> Informations générales**

## INFORMATIONS CONCERNANT LES FICHIERS

Fichiers à fournir :

- un fichier électronique avec le dessin graphique
- et un fichier différent pour le texte.

Pour un marquage au laser individuel, les textes devront être fournis uniquement sous format

Excel® (.xls).

## PROPRIÉTÉS DU MATÉRIEL GRAPHIQUE

Envoyez-nous votre matériel graphique dans un des types de fichiers suivants :

- JPG / 350 dpi sans compresser à la taille réelle de marquage (seulement images, sans texte)
- PDF / vectorisé
- Illustrator® CC / vectorisé
- Photoshop® CC / avec les couches
- Fichiers ZIP

Il est important que vous nous fassiez parvenir les informations dans l'un de ces formats afin de traiter au mieux votre commande et d'obtenir un résultat final optimal.

Si la création du client ne rentre pas dans notre format, nous modifierons en conséquence.

## TYPE DE CARACTÈRES:

- Tous les types de caractères doivent être convertis en image. Vérifiez les tailles minimales des types et les épaisseurs de trait.

Veillez contacter le service clientèle pour plus d'informations.

## SPÉCIAL POUR LES PRODUITS D'ÉCRITURE

La zone d'impression disponible dépend de la technique d'impression requise.

## SPÉCIAL POUR LES BRIQUETS (J25, J26, J38 ET J39)

Pour toute demande de couleur directe Pantone, nous pouvons proposer une impression avec une 5e couleur de ce Guide, à un prix majoré. Pour plus d'informations sur la manière d'obtenir la couleur correspondante la plus proche pour des impressions sur différents produits de notre catalogue, veuillez contacter notre service client.

**ES> Información general**

## INFORMACIÓN SOBRE ARCHIVOS

En cualquier caso, los archivos deben ser dos:

- un archivo electrónico con el diseño gráfico (creatividad)
- y otro archivo distinto para el texto.

Para un grabado en láser, facilite los textos únicamente en formato Excel® (.xls).

## PROPIEDADES DEL MATERIAL GRÁFICO

Envíenos su material gráfico en alguno de los siguientes tipos de archivo:

- JPG/ 350 dpi sin comprimir al tamaño real de impresión (sólo imágenes, sin texto)
- PDF / vectorizado
- Illustrator® CC / vectorizado
- Photoshop® CC / con capas
- Archivos ZIP

Es importante que nos proporcione la información en uno de estos formatos para agilizar su pedido y para obtener un resultado final adecuado. Si el diseño del cliente no encaja correctamente en el área de impresión, lo modificaremos consecuentemente.

## FUENTES:

- Todos los tipos de letra se deben convertir en un arte final. Verifique los tamaños de los tipos mínimos y grosores de línea.

Por favor, contacte con Atención al Cliente para más información.

## ESPECIAL PARA INSTRUMENTOS DE ESCRITURA

Área de impresión disponible según la técnica de impresión.

## ESPECIAL PARA ENCENDADORES EN DIGITAL (J25, J26, J38 &amp; J39)

En el caso de querer un color directo, podemos ofrecer la impresión con un 5º color de dicha Guía. Para una mejor coincidencia de color entre los diferentes productos de nuestro catálogo, póngase en contacto con nuestro departamento de Atención al Cliente.

**DE> Allgemeine Information**

## DRUCKVORLAGEANFORDERUNGEN :

Bitte senden Sie uns folgende Dateien:

- reprofähige Druckvorlagen als Grafik
- Separate Textdatei.

Für personalisierte Lasergravuren müssen die Texte im Excel®-Format (.xls) eingeschickt werden.

## TECHNISCHE DATEN DER GRAFIKDATEIEN

Bitte schicken Sie Ihre Grafiken in einem dieser Formate:

- JPG / 350 dpi nicht komprimiert und in der tatsächlichen Druckgröße (nur Bilddaten, kein Text)
- PDF / Vektordatei
- Illustrator® CC / Vektordatei
- Photoshop® CC / mit Ebenen
- ZIP format

Wir bitten um Zusendung der Daten in den angegebenen Formaten.

Damit können wir den Auftrag schnellstmöglich bearbeiten und ein optimales Druckergebnis erreichen. Sofern der Entwurf des Kunden nicht in unseren Druckbereich passt, werden wir ihn entsprechend anpassen..

## SCHRIFTARTEN:

- Alle Schriftarten müssen in eine Vorlage umgewandelt werden.

Überprüfen Sie die Mindestschriftgrößen und Linienstärken. Für weitere Informationen

kontaktieren Sie bitte unseren Kundenservice

## SPEZIELL FÜR SCHREIBPRODUKTE

Die mögliche Werbeaufdruckfläche ist von der angeforderten Drucktechnik abhängig.

## SPEZIELL FÜR DIGITALE FEUERZEUGE (J25, J26, J38 UND J39)

Wenn Sie ausdrücklich eine Pantone-Farbe wünschen, können Sie zusätzlich eine fünfte Farbe aus unserem verfügbaren Repertoire auswählen. Hierfür wird ein Aufpreis berechnet. Weitere Informationen zur Farbangleichung bei Bestellung verschiedener Produkte erhalten Sie von Ihrem Kundenservice..

**IT> Informazioni Generali**

## INFORMAZIONE SUI FILE :

- Sempre, per quanto riguarda i file, i documenti si devono inviare come di seguito:

- un file elettronico con il design grafico (creatività)
- ed un altro file separato per il testo. Per un'incisione a laser singola, consegnare i testi esclusivamente in formato Excel® (.xls).

## PROPRIETÀ DEL MATERIALE GRAFICO

Inviateci il vostro materiale grafico in uno dei seguenti tipi di file:

- JPG / 350 dpi non compresso e nel formato reale della stampa (solo per le immagini, non per il testo)
- PDF / vettorializzato
- Illustrator® CC / vettorializzato
- Photoshop® CC / con livelli
- file ZIP

E' importante che le informazioni vengano mandate in uno dei formati indicati al fine di sveltire l'ordine ed ottenere un miglior risultato finale. Nel caso in cui il design del cliente non si adattasse all'area di stampa, verrà adattato di conseguenza.

## CARATTERI:

- Tutti i caratteri devono essere convertiti in immagine. Verificare le dimensioni minime del carattere e gli spessori del tratto.



## SPECIALE PER PRODOTTI DI SCRITTURA

L'area di stampa disponibile dipende dalla tecnica desiderata.

## SPECIALE PER ACCENDINI DIGITALI (J25, J26, J38 E J39)

Se si desidera un colore preciso, potrebbe essere scelto un quinto colore dalla suddetta guida a un costo aggiuntivo. Per maggiori informazioni sulla migliore corrispondenza del colore di stampa per i vari prodotti del nostro catalogo, contattare il nostro Servizio Clienti.

# TECHNICAL PARAMETERS FOR EACH TYPE OF PRINTING

	SCREEN PRINTING/ PAD PRINTING		HOT STAMPING / DEBOSSING		LASER ENGRAVING	
Minimum positive text	6 pt (2.1 mm)	6 Point text	10 pt (3.5 mm)	10 Point text	6 pt (2.1 mm)	6 Point text
Minimum negative text	9 pt (3.1 mm)	9 Point text	15 pt (5.25 mm)	15 Point	NON RECOMMANDÉ	
Minimum thickness for positive lines	0.4 pt (0.14 mm)		1.5 pt (0.5 mm)		0.3 pt (0.1 mm)	
Minimum thickness for negative lines	0,5 pt (0.176 mm)		2 pt (0.706 mm)		0.5 pt (0.17 mm)	
Minimum thickness for half tones	1.5 pt (0.5 mm)		PAS POSSIBLE		PAS POSSIBLE	
Percentage half tone	50%					
<b>STICKY NOTES</b>			<b>DIGITAL / DIGITAL TRANSFER</b>			
Minimum positive text	4 pt (1.4 mm)	4 Point text	4 pt (1.4 mm)	4 Point text		
Minimum negative text	5 pt (1.75 mm)	5 Point text	7 pt (2.4 mm)	7 Point text		
Minimum text for half tone	7 pt (2.4 mm)	7 Point text	1.5 pt (0.5 mm)	7 Point text		
Minimum thickness for positive lines	0.3 pt (0.1 mm)		0.25 pt (0.08 mm)			
Minimum thickness for negative lines	0.5 pt (0.17 mm)		0.5 pt (0.17 mm)			
Minimum thickness for lines in half tone	0.5 pt (0.17 mm)		0.5 pt (0.17 mm)			
Minimum half tone values	C: 5% / M: 5% / Y: 15% / K: 5% 		C: 8% / M: 8% / Y: 12% / K: 8% 			
<b>britePix™</b>						
Minimum positive text	6 pt (2.1 mm)	6 Point text				
Minimum negative text	7 pt (2.4 mm)	7 Point text				
Minimum thickness for positive lines	0.4 pt (0.14 mm)					
Minimum thickness for negative lines	0.5 pt (0.17 mm)					
Minimum thickness for half tones	1 pt (0.35 mm)					
Percentage half tone						

## SPECIAL IMPRINT COLOURS

### NOTEBOOKS

Hot-stamping colours



### EXACT COLOURS WITH WHITE UNDERLAYER REQUIREMENT

There are some colour references that need a white underlayer when we print on dark surfaces (Black, Dark blue, Red) in order to get the result required by the customer.

- In case the product only allows 1 imprint, the Customer Service representative will inform the customer that the final imprinted colour will be approximate.
- In case the product allows an additional imprint, the Customer Service representative will offer the customer the possibility to obtain the exact colour WITH a white underlayer (at extra cost).

**FR> Informations générales**

Paramètres techniques pour chacun des types d'impression  
 SERIGRAPHIE / TAMPOGRAPHIE - ESTAMPAGE / EMBOSSEMENT  
 LASER-STICKY NOTES - DIGITAL / TRANSFERT DIGITAL- britePix™  
 Texte positif minimum  
 Texte négatif minimum  
 Épaisseur minimale des lignes positives  
 Épaisseur minimale des lignes négatives  
 Épaisseur minimale des demi-teintes  
 Pourcentage de demi-teinte  
 Valeur minimale de demi-teinte

COULEURS SPÉCIALES D'IMPRESSION NOTEBOOKS  
 Couleurs d'estampage à chaud

COULEURS EXACTES QUI REQUIÈRENT UNE COUCHE DE FOND  
 BLANCHE  
 Plusieurs références de couleur requièrent une couche de fond blanche  
 lorsqu'elles sont imprimées sur des surfaces foncées (noir, bleu foncé,  
 rouge) pour pouvoir obtenir le résultat souhaité par le client.

- Si le produit permet seulement 1 impression, le représentant du service clients devra prévenir le client que le résultat de la couleur imprimée sera approximatif.
- Si le produit permet une impression supplémentaire, le représentant du service clients offrira au client la possibilité d'obtenir la couleur exacte AVEC une couche de fond blanche (moyennant majoration du prix)

**ES> Información general**

Parámetros técnicos para cada tipo de impresión  
 SERIGRAFÍA / TAMPOGRAFÍA - HOTSTAMPING / GRABADO EN  
 RELIEVE - LÁSER - STICKY NOTES - DIGITAL / TRANSFERENCIA  
 DIGITAL - britePix™  
 Texto mínimo positivo  
 Texto mínimo negativo  
 Grosor mínimo para líneas positivas  
 Grosor mínimo para líneas negativas  
 Grosor mínimo de marca de agua  
 Porcentajes de marca de agua  
 Valores mínimos de marca de agua

IMPRESIÓN DE COLORES ESPECIALES NOTEBOOKS  
 Colores para Hot-stamping

COLORES EXACTOS QUE REQUIEREN UNA PASADA DE BLANCO  
 DEBAJO  
 Hay varias referencias de colores que necesitan una pasada de blanco  
 debajo cuando son impresos sobre superficies oscuras (negro, azul  
 oscuro, rojo) para obtener el resultado que requiere el cliente.

- En caso que el producto solo admita 1 color de marcado, el representante de atención al cliente informará al cliente de que el resultado será aproximado.
- En caso que el producto permita una pasada más, el representante de atención al cliente ofrecerá al cliente la posibilidad de obtener el color exacto imprimiendo una pasada de blanco (con extra coste).

**DE> Allgemeine Information**

Technische Parameter für jeden Typendruck  
 SIEBDRUCK / TAMPOND RUCK - HOTSTAMPING / PRÄGUNG -  
 LASERGRAVUR - STICKY  
 NOTES - DIGITAL / DIGITALDRUCK - britePix™  
 Minimum positiver Text  
 Minimum negativer Text  
 Mindeststärke für Linien im Positivdruck  
 Mindeststärke für Linien im Negativdruck  
 Mindeststärke für Halbtöne  
 Prozentsatz Halbtöne  
 Mindestwerte für Halbtöne

SPEZIELLE WERBEAUFDRUCKFARBEN NOTEBOOKS  
 Farben für Heißprägung

FARBGETREUE FARBEN, FÜR DIE EIN WEISSER UNTERGRUND  
 ERFORDERLICH IST

Es gibt verschiedene Farbreferenzen, für die ein weißer Untergrund  
 erforderlich ist, wenn auf dunklen Flächen gedruckt werden soll (schwarz,  
 dunkelblau, rot), um das vom Kunden gewünschte Resultat zu erzielen:

- Falls für das Produkt nur ein Aufdruck möglich ist, wird ein Mitarbeiter des Kundendienstes den Kunden darüber informieren, dass die aufgedruckte Farbe nur annähernd dem gewünschten Farbton entspricht.
- Ist für das Produkt ein zusätzlicher Aufdruck möglich, wird der Kundendienstmitarbeiter dem Kunden das Angebot machen, die gewünschte Farbe (gegen Aufpreis).

**IT> Informazioni Generali**

Parametri tecnici per ciascun tipo di stampa  
 SERIGRAFIA / TAMPOGRAFIA - STAMPA A CALDO/ BASSORILIEVO  
 - LASER - STICKY NOTES - DIGITALE / TRASFERIMENTO - DIGITALE-  
 britePix™  
 Testo positivo minimo  
 Testo negativo minimo  
 Spessore minimo per linee positive  
 Spessore minimo per linee negative  
 Spessore minimo per mezzi toni  
 Percentuale mezzo tono  
 Valori minimi mezzo tono

COLORI STAMPA SPECIALE NOTEBOOKS  
 Colori stampa a caldo

COLORI PRECISI CON NECESSITÀ DI SFONDO BIANCO  
 Alcuni codici di colore richiedono uno sfondo bianco in caso di stampa  
 su superfici scure (nero, blu scuro, rosso) in modo da ottenere il risultato  
 desiderato.

- Se il prodotto consente solo 1 stampa, il referente del servizio clienti informerà che il colore finale della stampa potrebbe essere leggermente diverso.
- Se il prodotto consente un'ulteriore stampa, il referente del servizio clienti offrirà la possibilità di ottenere il colore esatto CON uno sfondo bianco (con un supplemento di prezzo).

# PRODUCT INDEX

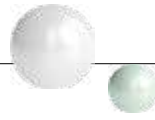

	PAGE
<b>BIC® WRITING INSTRUMENTS</b>	
BIC® Style.....	46
BIC® Round Stic.....	50
BIC® M10 Clic.....	54
BIC® Media Clic.....	58
BIC® Media Clic Grip.....	62
BIC® Media Clic Shine.....	66
BIC® Media Clic Bio Ecolutions.....	68
BIC® Clic Stic.....	72
BIC® Super Clip.....	82
BIC® Super Clip Advance.....	86
BIC® Wide Body.....	92
BIC® Wide Body Chrome.....	94
BIC® Atlantis.....	100
BIC® 4 Colours.....	104
BIC® 4 Colours Mini.....	108
BIC® 4 Colours Sun.....	109
BIC® 4 Colours Fashion.....	110
BIC® 4 Colours Shine.....	112
BIC® 4 Colours Fine.....	114
BIC® 4 Colours Fluo.....	115
BIC® 4 Colours Stylus.....	116
BIC® 4 Colours 3+1.....	117
BIC® Metal Pro.....	120
BIC® Grip Roller.....	126
BIC® XS Finestyle.....	128
BIC® Atlantis Gel.....	131
BIC® Ge-Ocity Illusion.....	132
BIC® Intensity Gel Clic.....	134
BIC® Brite Liner Grip.....	138
BIC® Velleda White Board Marker Fine.....	142
BIC® Velleda White Board Marker Grip.....	143
BIC® Mark-It Permanent Marker.....	144
BIC® Permanent Marker Ecolutions.....	145
BIC® Matic.....	148
BIC® Evolution Ecolutions.....	153
BIC® Sprout.....	159
BIC® Plastidecor Set of 6 Crayons.....	164
BIC® Evolution Ecolutions Set of 6 Colouring Pencils.....	165
CONTE Set of 6 Colouring Pencils.....	166
BIC® Colouring Set.....	167
CONTE by BIC® Colouring Set.....	170
TIPP-EX Mini Pocket Mouse BritePix.....	173

	PAGE
<b>OTHER WRITING INSTRUMENTS</b>	
Basic Pen.....	176
Click Pen.....	178
Stripped Grip Pen.....	180
White Striped Grip Pen.....	182
Sleek Stylus Pen.....	184
<b>BIC® STICKY NOTES</b>	
BIC® 50 mm x 75 mm Adhesive Notepads.....	190
BIC® 68 mm x 75 mm Adhesive Notepads.....	192
BIC® 75 mm x 75 mm Adhesive Notepads.....	194
BIC® Small Adhesive Die Cut Notepads.....	196
BIC® 101 mm x 75 mm Adhesive Notepads & BIC® 101 mm x 75 mm Alternating Sheet Imprint.....	198
BIC® Medium Adhesive Die Cut Notepads.....	200
BIC® 101 mm x 101 mm Adhesive Notepads.....	202
BIC® 101 mm x 130 mm Adhesive Notepads.....	204
BIC® 75 x 127 mm Non-Adhesive Scratch Pad.....	206
BIC® 96 x 152 mm Non-Adhesive Scratch Pad.....	207
BIG Flag Booklet.....	210
BIC® 75 x 75 Booklet.....	212
BIC® 101 x 75 Booklet.....	214
BIC® 75 x 75 Adhesive Notepad With Flag Booklet.....	216
BIC® Clic Stic Organiser & BIC® Clic Stic Mini Digital Organiser.....	218
BIC® 150 x 150 mm Booklet Organiser.....	222
BIC® 150 x 150 mm Booklet With Pen Loop.....	224
<b>BIC® NOTEBOOKS</b>	
BIC® Notebooks Dual A5.....	229
BIC® Notebooks Dual A6.....	232

	PAGE
<b>BIC® LIGHTERS</b>	
BIC® J25 Lighter.....	242
BIC® J23 Lighter.....	246
BIC® J26 Lighter.....	250
BIC® J38 Lighter.....	254
BIC® J39 Lighter.....	258
BIC® Mega Lighter.....	262
BIC® Styl'it Luxury Case.....	264
BIC® Aluminium Flat Case.....	266
BIC® Clip Case.....	267
BIC® 3D Case.....	268
BIC® Pocket Ashtray.....	269
<b>BIC® SHAVERS</b>	
BIC® Comfort 2 For Men.....	274
BIC® Flex3 Classic For Men.....	276
BIC® Flex4 For Men.....	278
BIC® Comfort 2 Lady Form Women.....	280
BIC® Pure 3 Lady For Women.....	282
BIC® Soleil Bella Lady For Women.....	284
<b>BIC® BAGS</b>	
BIC® Drawstring Backpack.....	288
BIC® Classic Backpack.....	290
BIC® Multi-Use Pouch.....	292
<b>TECHNOLOGY</b>	
Mouse Pad.....	296
T'NB Lumy Wireless Mouse & TN'BLumy Wired Mouse.....	297
TN'B Rainbow Mouse.....	298
TN'B Stone Powerbank 41000 mAh & 6600 mAh.....	299
TN'B Ultra-Slim Powerbanks 4000 mAh & MFI Adapter.....	300
TN'B Slim Powerbank 6000 mAh.....	301
SKROSS World To Europe USB.....	302
SKROSS Pro Light USB.....	303
SKROSS World Adapter MUV USB.....	304
<b>BIC® PACKAGING</b>	
BIC® Packaging.....	306

# COLOUR TABLE

Nuancier de couleurs / Gama de colores / Farbindex / Tavolozza dei colori

01 White	1E White recycled	57 Opaque white	3C White pearl	01 BIO white	1T White polished	51 Transparent	69 Frosted white	2E Frosted white recycled	1R White clear	
8D Yellow pastel	2F Acid yellow	8G Light yellow	12 Yellow	8T Yellow polished	63 Frosted yellow	012 BIO yellow	4D Clear yellow	6F Light brown	29 Bronzed gold	26 Gold
1G Acid orange	10 Orange	6P Orange polished	90 Orange pastel	71 Frosted orange	92 Clear orange	3J Coral orange				
03 Red	3T Red polished	8E Red recycled	87 Clear red	03 BIO red	66 Frosted red	4G Metallic red	08 Burgundy			
14 Pink	3G Light pink	3H Coral pink	5C Pink fizz	95 Clear pink	6T Pink polished	2C Pink metallic				
2M Purple	84 Purple pastel	93 Clear purple	13 Violet	39 Frosted purple	4B Frosted purple	7G Metallic purple	2D Purple	93 Clear dark purple	9T Polished purple	
8C Lime	85 Green pastel	68 Frosted green	6C Grass green	88 Clear light green	59 Apple green	2G Acid green	5P Green polished	82 Frosted dark green	72 Clear green	5G Light green
5T Green polished	05 Green	20 Dark green	7E Dark green recycled	88 Clear dark green	05 BIO green	2B Jungle	3B Frosted jungle			
83 Blue pastel	3D Caribbean blue	4T Caribbean blue polished	4R Clear caribbean blue	34 Metallic blue	86 Clear blue	67 Frosted blue	24 Light blue	04 BIO blue	04 Blue	40 Frosted dark blue
34 Metallic dark blue	1D Metallic dark blue	7R Navy clear	89 Clear dark blue	25 Dark blue	07 Navy blue	10E Navy blue recycled	50 Royal blue	7T Navy		
35 Chrome	47 Silver	75 Metallic silver	18 Metal	06 Grey	8L Grey polished	91 Clear black	65 Frosted black	8H Clear dark grey	8A Bronze	
02 BIO black	2T Black polished	02 Black	3E Black recycled							

The colours shown above are for reference only. Actual colour may vary slightly depending on the product. Ces couleurs sont de nature indicative et non contractuelle. Leur rendu peut donc varier en fonction de la matière sur laquelle elle sont apposées / Los colores arriba indicados, son sólo una referencia. El color real puede variar dependiendo del producto / Die oben angeführten Farben dienen ausschließlich der Veranschaulichung. Leichte Abweichungen können je nach Produkt entstehen / I colori esposti sopra sono solo un riferimento. I colori reali possono essere leggermente diversi, a seconda del prodotto.



*graphic*

*Your Brand Ambassador*

[www.bicgraphic.eu](http://www.bicgraphic.eu)